



User Manual

ECO-SLH-DC

Stainless Steel Indoor Digital Clock



Scan the QR code or enter following URL to get the latest version:
<https://docs.mobatime.cloud/ECO-SLH-DC>

Regulations and Certification

The device fulfils the requirements of the following standards:

Electrical safety :	EN 62368-1 ED.2
EMC :	EN 55032 ED.2; EN 55035; EN 50121-4 ED.4

This product was developed and produced with the following EU directives:

EMC :	Electromagnetic compatibility directive 2014/30/EU
LVD :	Low voltage directive 2014/35/EU
RED :	Radio equipment directive 2014/53/EU
RoHS II :	Restriction of the use of certain hazardous substances directive 2011/65/EU
WEEE :	Waste electrical and electronic equipment directive 2012/19/EU
REACH :	Chemical substance directive ES 1907/2006

See Conformity for the declaration of conformity of this specific product. This product may offer a CB test certificate on request.



Important Notes

1. Please read and follow the safety information in this document before operating the product. We cannot guarantee that no accidents or damage will occur to improper use of this product. Please use this product with care and operate at your own risk.
2. We are not liable for any direct or indirect damage caused by the use of this document or the said product.
3. This product must be connected and installed by qualified electrician who is familiar with the relevant regulations (e.g. VDE).
4. The information in this document is subject to change without notice. The latest version of this document is available for download at <https://docs.mobatime.cloud/ECO-SLH-DC/>.
5. The product firmware is continuously being optimized and supplemented with new options. The latest firmware is available for download at <https://docs.mobatime.cloud/ECO-SLH-DC/firmware/>.
6. This User Manual has been composed with the utmost care to explain all the details to ensure a safe and stable operation of this product. Nevertheless, if question arise or error appear, feel free to contact support.
7. **Two Years Limited Product Warranty.** ELEKON, s.r.o. warrant MOBATIME branded hardware product contained in the original packaging against defects in materials and workmanship when used normally in accordance with the MOBATIME's guidelines for period of TWO YEARS from the date of original retail purchase by the end-user purchaser.
8. No part of this document or the said product may be reproduced in any form or by any means or used to make any derivative such as translation, transformation, or adaption without permission from ELEKON, s.r.o., Brněnská 364/17, Vyškov 682 01 / CZECH REPUBLIC.
9. Copyright © 2024 ELEKON, s.r.o., Brněnská 364/17, Vyškov 682 01 / CZECH REPUBLIC. All rights reserved.

Table of Contents

1. Safety	8
1.1. Instructions and Symbols	8
1.2. General	8
1.3. Installation	9
1.4. Operation	9
1.5. Maintenance and Cleaning	10
1.6. Disposing	10
1.7. Warranty	10
2. Mounting	11
2.1. Flush mounting	11
2.2. Cable Connection	13
3. Clock Operation	20
3.1. Non-network Clock Operation	20
3.1.1. DCF 77 Receiver	20
3.1.2. GPS Receiver	21
3.1.3. GPS Receiver (GNSS 4500)	21
3.1.4. Synchronizing Impulses	22
3.1.5. MOBATIME Serial Code, MOBALine or IRIG-B	23
3.1.6. IF482 Control over RS-485	24
3.2. Network Clock Operation	24
3.2.1. Unicast Mode	25
3.2.2. Multicast Mode	26
3.2.3. Network Parameters Assigned by DHCPv4	26
3.2.4. Manual Settings through Setup Menu	27
3.2.5. Calculation of Link Local Address	27
3.2.6. Setting Network Parameters over Autoconfiguration (SLAAC)	27
3.2.7. Setting Network Parameters over DHCPv6	28
3.2.8. SNMP	28
3.2.9. HTTPS	30
3.2.10. WiFi Operation Modes	31
4. Settings	33
4.1. Control	33
4.2. Navigation scheme	34
4.3. Web Interface	37
5. Display Settings	46
5.1. Display Brightness	46
5.2. Timezone of Time and Date	47
5.3. Time Constants	47
5.4. 12-Hour Format	48

5.5.	Time with Leading Zero	48
5.6.	Date with Leading Zero	49
5.7.	Clock Address for IR Remote Controller	49
5.8.	IR Remote Controller Auto-Lock	50
5.9.	Remote Control Lock	50
6.	Synchronization Settings	52
6.1.	Timezone of Synchronization Source	52
6.2.	Type of Synchronization	52
6.3.	Master Clock Time Zones	53
6.4.	Transmission Parameters for RS-485	54
6.5.	Timeout for Indication of State without Synchronization	55
6.6.	Offset of Displayed Time	55
7.	Network Settings	56
7.1.	IP Mode	57
7.2.	Communication Mode	57
7.3.	DHCPv4 Mode	57
7.4.	IP Address	58
7.5.	Subnet Mask	58
7.6.	Default Gateway	59
7.7.	Multicast Address	59
7.8.	Unicast NTP Address	60
7.9.	NTP Polling Interval	60
7.10.	Address Autoconfiguration (SLAAC)	60
7.11.	DHCPv6 Mode	61
7.12.	WiFi Mode	61
7.13.	Multicast Mode for Configuration of Digital Clock	62
7.14.	SNMP Protocol	62
7.15.	Web Server	62
7.16.	Web Server Security Mode	63
7.17.	Link Local Address	63
7.18.	Autoconfiguration SLAAC	64
7.19.	First address from DHCPv6	64
7.20.	Manually set IPv6 address	65
7.21.	Prefix for manually set IPv6 address	66
7.22.	Gateway from autoconfiguration SLAAC	67
7.23.	MAC address	67
8.	Sensor Settings	69
8.1.	Sensor Type	69
8.2.	Input number for sensor One-Wire	70
8.3.	Temperature sensor	70
8.4.	Humidity sensor	72
8.5.	Pressure sensor	74
8.6.	LAN sensor	75
9.	Stopwatch settings	77
9.1.	Stopwatch start time	77

9.2.	Counting direction	77
9.3.	Control mode	78
9.4.	Counting unit	84
9.5.	Contact closing	84
9.6.	External keyboard connection	85
9.7.	Timeout to switch to default display for BRB	85
9.8.	BRB10 connection	86
10.	Time & date settings	87
10.1.	Time	87
10.2.	Date and year	87
11.	System Settings	89
11.1.	Diagnostic tools	89
11.2.	Factory Reset	93
11.3.	Firmware update via USB process settings	94
11.4.	Clock Address for IR Remote Controller	95
11.5.	IR Remote Controller Auto-Lock	95
11.6.	Remote Control Lock	96
11.7.	Display Brightness Derating	96
11.8.	Light Sensor Correction	97
11.9.	Individual Digit Brightness Setting	98
11.10.	Individual Dot Brightness Setting	98
12.	Power modes	100
12.1.	Power OFF	100
12.2.	Power SAVE	101
13.	Share Mode	104
13.1.	Interface Setting	104
13.2.	UDP Port Setting	105
13.3.	Sharing Display Mode (Default Display, Stopwatch)	105
13.4.	Sharing Stopwatch	106
13.5.	Sharing Relay	106
13.6.	Sharing Display Brightness	106
13.7.	Sharing Screen	107
13.8.	Sharing Time	107
13.9.	Sharing Sensor 1	107
13.10.	Sharing Sensor 2	108
13.11.	Local Stopwatch Setting	108
13.12.	Examples of Share Mode Settings	108
14.	Local time calculation	113
14.1.	According to Synchronization Source	113
14.2.	According to MOBALine Timezones	113
14.3.	According to MOBA-NMS Preconfigured Timezones	113
14.4.	According to Server MOBATIME	114

14.5. According to Internal Timezone Table	114
15. Time Zones Table	115
16. Factory Reset Using Push-Buttons	118
16.1. Procedure	118
17. Firmware update	119
17.1. Firmware update via MOBA-NMS	119
17.2. Firmware update via SNMP	119
17.3. Firmware update via web server	119
17.4. Firmware update via USB	120
18. Clock specifications	122
18.1. Technical Parameters	122
18.2. Diagram & dimensions	123
18.2.1. Without back cover	11
18.2.2. With back cover	12
18.2.3. Dimensions	124
18.3. VDC option voltage table	125
18.4. VDISP option voltage table	126
18.5. LGC variant voltage table	127
19. Frequently asked questions	128
19.1. General Questions	128
19.2. Local time calculation Questions	128

1 Safety



Read the safety instructions carefully and follow all the instructions. This ensures safe and reliable operation of this device.

1.1. Instructions and Symbols

Symbols used throughout this document and their meaning are as follows:



A note or important information.



Answer to a possible question. Contact information.



Keep away from children and people with limited physical, sensory, or mental capacities.



Action needs to be taken.



Connect device to earth ground.



More information included in the manual. It also indicates navigation in the clock menu.



Disconnect mains power before doing anything.



An example or a hint.



Additional references or information.



Attention of electrical shocks.



Surface may be hot.



Item is flammable.



A warning, be cautious.



Recyclable materials.



Do not put in trash.

1.2. General



For safety and licensing reasons, unauthorized modifications and/or changes to the product is prohibited. Maintenance, adjustments or repairs may only be carried out by the factory (copyright holder).



This product is not a toy; it does not belong in the hands of children. Mount or place the product so that it cannot be reached by children. Children may try to insert objects into the product. The product will not only be damaged, but there is also a risk of injury, as well as danger to life through electric shock.



Never open the housing of this product, for it poses mortal danger from electric shock or may even cause a fire.

Keep packaging such as plastic films away from children. There is the risk of suffocation of misused.



Use caution with the product, knocks, blows, or even falls from a low height can damage it.



In industrial facilities, the accident prevention regulations of the trade associations for electrical systems and equipment must be observed.

Do not use the product if it is damaged. It can be assumed that safe operation is no longer possible, if:

- The product has visible damage.
- The product is not working properly (thick smoke or a burning smell, audible crackling noise, discoloration of the product or surrounding areas).
- The product was stored under adverse conditions.
- Tough conditions during transport.



Improper handling of this product operated on the mains voltage can cause mortal danger from electric shock!



Interconnection or combining equipment bearing a CE label does not inevitably result in a system that conforms with the safety regulations. Integrators will have to reassess the new product's compliance according to the locally valid directives. See section Conformity for more information on certifications of this product.

1.3. Installation

This product must be connected and installed by a qualified electrician who is familiar with the relevant regulations (e.g. VDE).



Never plug the product into voltage / power supply immediately after it has been moved from cold into warm environment (e.g. during / after transport / unboxing). The resultant condensed water may damage the product or may cause electric shock.



Allow the product reach the ambient temperature. Wait until the condensation has evaporated, this can take a few hours. Only then can the product be connected to the voltage / current supply and put into operation.



This product may have screw terminals with open electrical contacts. It is essential to ensure that the connection is made only when no voltage / current is applied. Secure the power supply to prevent accidental reconnection. Verify the absence of voltage using an appropriate meter.



The power supply line must be protected with a residual current circuit breaker (RCCB) with a trip current ≤ 30 mA.



Always connect earth ground to the device at the indicated protective earth terminal (PE or earth symbol indication).



Always unplug a power plug from the socket only at the intended gripping surface, pull the power plug not the cord from a power outlet. Wires may rip out and pose danger to life though electric shock.



Maintain sufficient cooling of the product according to its specifications.

1.4. Operation

Use the product in the specified environment. Use outside of the specifications can damage the product and/or stop any operation.

The product may not be exposed to extreme temperatures, direct sunlight or strong vibrations. Protect the product from moisture, dust and dirt.



Operation in environments with excessive dust, flammable gases, vapours or solvents is not permitted. It may cause explosion or fire.



Depending on the cooling type, the product housing may reach temperatures above 60 °C, which can burn the skin.

- Do not overload the product. Note the input / output voltage and currents as well as output powers indicated on the product.
- Depending on the input currents and input voltages, suitable connecting cables with appropriate cable diameter must be used. Only use the plugs and connectors supplied in the original packaging with the product.

1.5. Maintenance and Cleaning

- If the product and/or the connecting cable is damaged, do not touch it: there is mortal danger from electric shock! First, turn off the power supply to all poles of the product (turn off associated circuit breaker or remove the fuse, then turn off GFCI). Verify the absence of voltage using an appropriate meter.
- For the end consumer, the product is maintenance-free. Leave any maintenance to an expert. Repairs may only be done by the factory itself (copyright holder).
- For external cleaning one can use a clean, soft, dry cloth. Dust can be easily removed with a clean, soft brush and a vacuum cleaner.



Unplug all poles of the product from the operating voltage before cleaning.

- You can use cleaning / disinfection supplies on stainless steel frame for extra cleanliness.
- This product is equipped with fuses for protection against high voltage and high currents. Burned fuses may only be replaced by the factory itself (copyright owner).



Never bridge a fuse, it is a fire hazard and can cause a fatal electric shock.

1.6. Disposing



At the end of its lifecycle, do not dispose of this device in the regular household rubbish. Return it to the supplier who will dispose of it correctly.



The user is lawfully obligated to return unusable batteries. **Disposal of used batteries through household waste is prohibited!** Batteries which contain dangerous substances are labelled with a picture of crossed out trash bin. The symbol means that this product may not be disposed through household waste.

Unusable batteries can be returned free of charge at appropriate collection points of your waste disposal company or at shops that sell batteries. By doing so, you fulfil your legal responsibilities and help protect the environment.



This product was packed and stuffed with proper materials to protect it during transportation. Packaging materials can be recycled and should be disposed environmentally friendly.

1.7. Warranty

The device is intended for a normal operational environment according to the corresponding norm.

The following circumstances are excluded from the warranty:

- Inappropriate handling or interventions.
- Chemical influences.
- Mechanical defects.
- External environmental influences (natural catastrophes, etc.)



Repairs during and after warranty period are assured by the manufacturer.

2 Mounting

2.1. Flush mounting

There exists two basic possibilities of mounting: mounting of clock into wall niche and mounting into a panel. For both mounting is **very important** to prepare appropriate holes according to drawing and clock body.

2.1.1. Without back cover

1. For wall niche mounting, drill four anchoring holes into a wall of a diameter adequate to accommodate appropriate screws of 4 to 5 mm diameter. As a template for marking the position of holes the clock body can be used.
2. For panel mounting, drill four anchoring holes of 2.6 mm diameter into a panel to accommodate screws of 4 to 5 mm diameter. As a template for marking the position of holes the clock body can be used.
3. On mains powered clock connect the incoming conductors in accordance with the description on the power supply unit using WAGO or equivalent clamps.
4. Mount the connectors to the cable of the synchronization signal line, the temperature sensor cable, to the keyboard cable, Ethernet or to the RS-485 if these are used.



If the clock is synchronized by LGC variant, please navigate to Clock Operation Non-Network Clock Operation to get detailed info about connection of various synchronization sources and receivers.

5. Push the synchronization line connector, the temperature sensor connector, the keyboard connector, Ethernet connector or the RS-485 jacks into the corresponding terminals on the control PCB.



Be careful not to swap terminals. Check the markings of the jack-plugs.

6. Put the clock into prepared hole. Check if any cables is not pinched between the clock body and hole / niche edges.

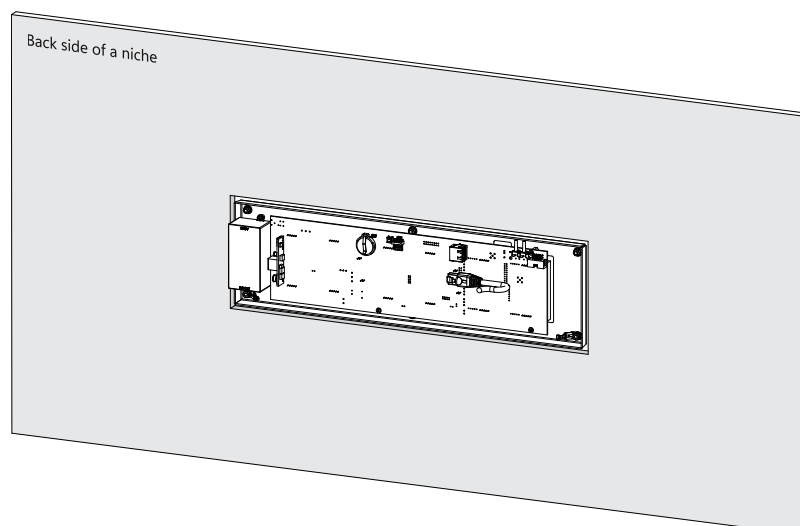

7. Fix the clock by four screws to panel / wall.

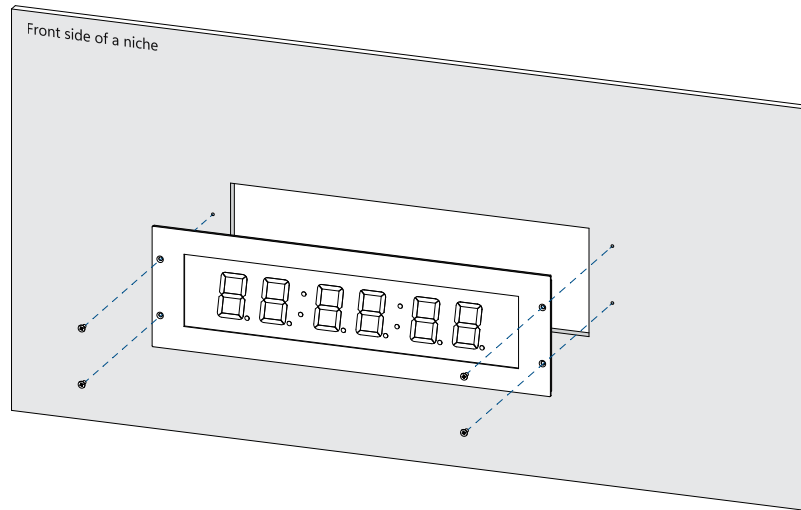

2.1.2. With back cover

1. The clock consists of clock part and back cover. Dismount 4 screws and remove the cover.
2. For wall niche mounting, drill two anchoring holes into a wall of a diameter adequate to accommodate appropriate screws of 4 to 5 mm diameter. As a template for marking the position of holes the back cover can be used.
3. For panel mounting, drill two anchoring holes of 2.6 mm diameter into the panel to accommodate appropriate screws of 4 to 5 mm diameter. As a template for marking the position of the holes the back cover can be used.
4. Pull incoming conductors through the hole in the back side of the cover and fix the cover to a wall / panel using screws.

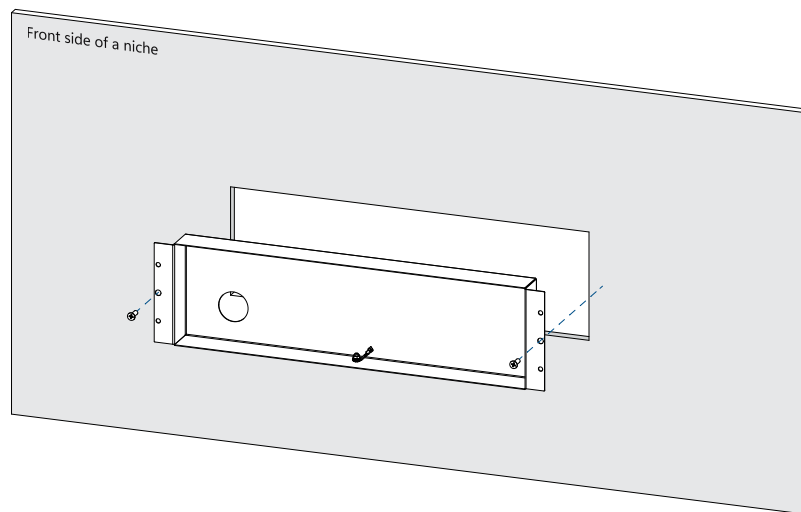

5. On mains powered clock connect the incoming conductors in accordance with the description on the power supply unit using WAGO or equivalent clamps.
6. Mount connectors to cable of synchronization signal line, temperature sensor cable, Ethernet cable or to RS-485 if these are used.



If the clock is synchronized by LGC variant, please navigate to Clock Operation Non-Network Clock Operation to get detailed info about connection of various synchronization sources and receivers.

For LGC variant, check and configure the position of DIP switch according to used synchronization signal (applies only for DCF, MOBALine, polarized impulse line or IRIG-B).

7. Push the synchronization line connector, the temperature sensor connector, the keyboard connector, Ethernet connector or the RS-485 jacks into the corresponding terminals on the control PCB.



Be careful not to swap terminals. Check the markings of the jack-plugs.

- Put the clock into prepared hole. Check if any cables is not pinched between the clock body and back cover.

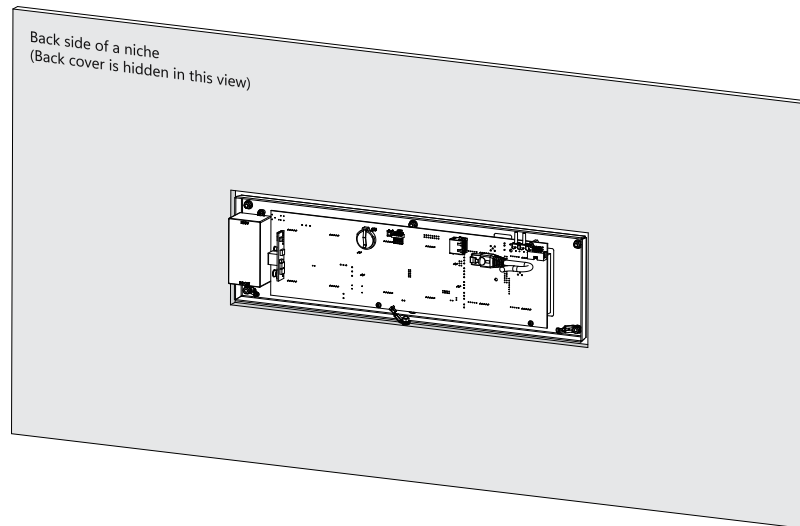

- Fix the clock by four delivered screws to back cover.

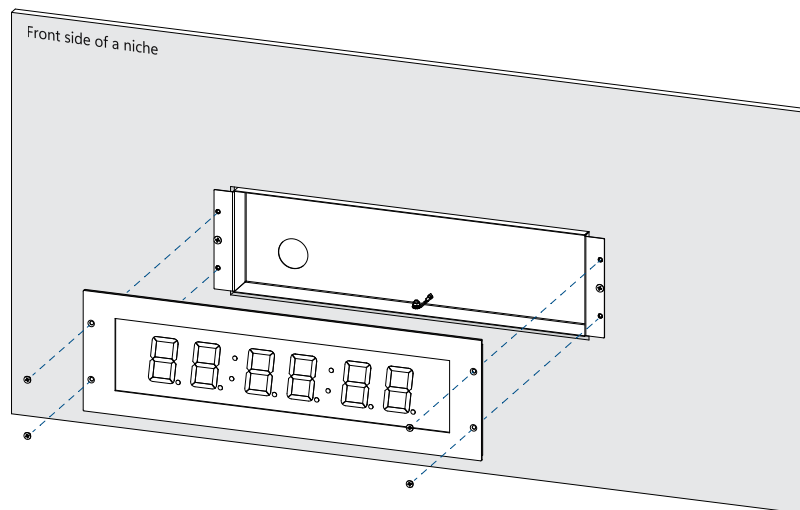

2.2. Cable Connection

2.2.1. Control Board

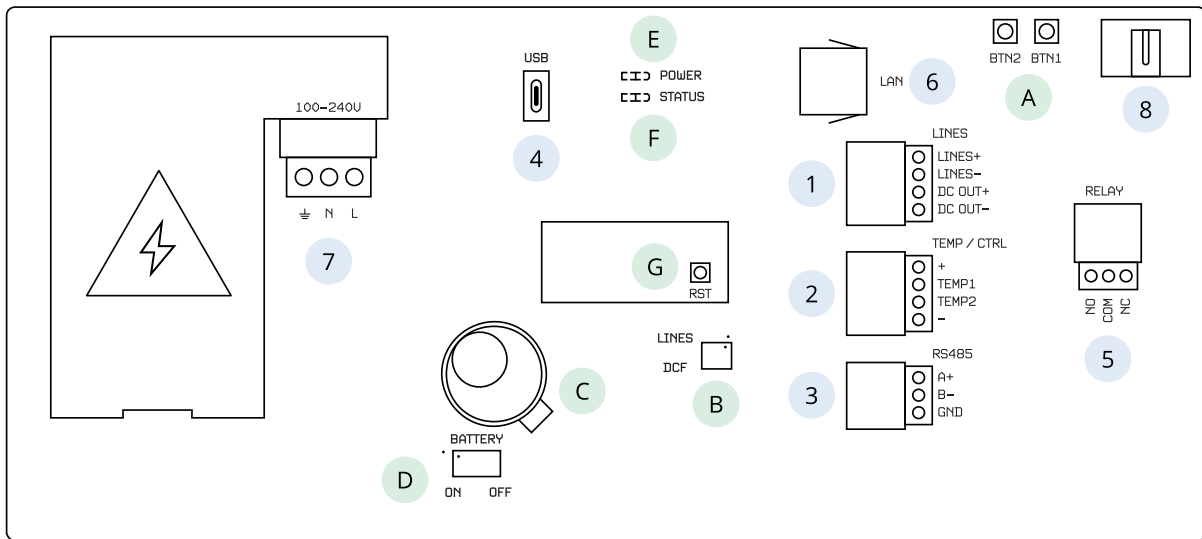

Description

- 1 LINES / DC OUT connector (only for LGC variant)
- 2 TEMP connector
- 3 RS 485 connector (only with RS 485 option)
- 4 USB connector (only for LGC variant and GPS option)
- 5 RELAY connector (only for option REL / REL-IP)
- 6 LAN connector (only for PoE and NTP variant)
- 7 POWER (except PoE variant)
- 8 DISP2 – connection for second side

- A Push-buttons PB1, PB2
- B DIP switch (only for LGC variant)
- C Battery (BAT option)
- D Connecting / disconnecting the backup battery (BAT option)
- E Powering LED indication
- F State LED
- G RESET button

2.2.2. Connecting Terminal Block



Not for PoE variant

Standard Connection

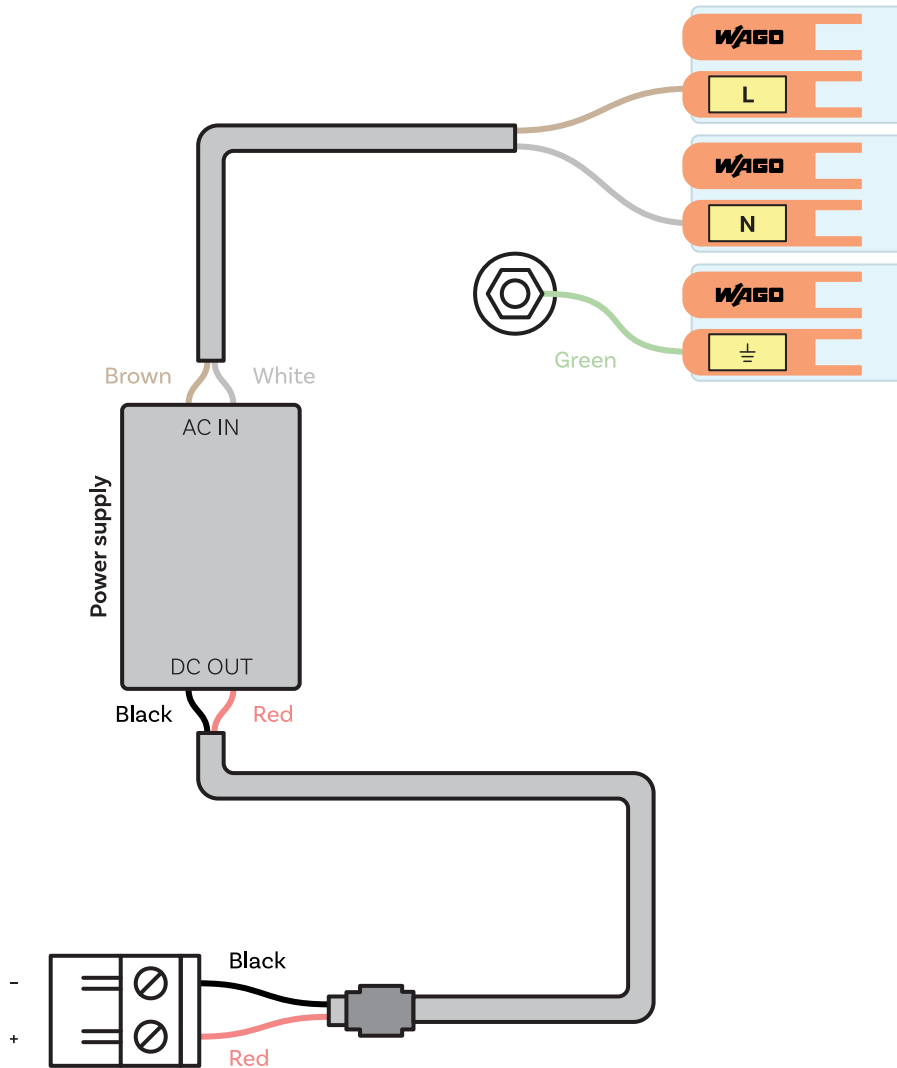

For VDC or RP Option

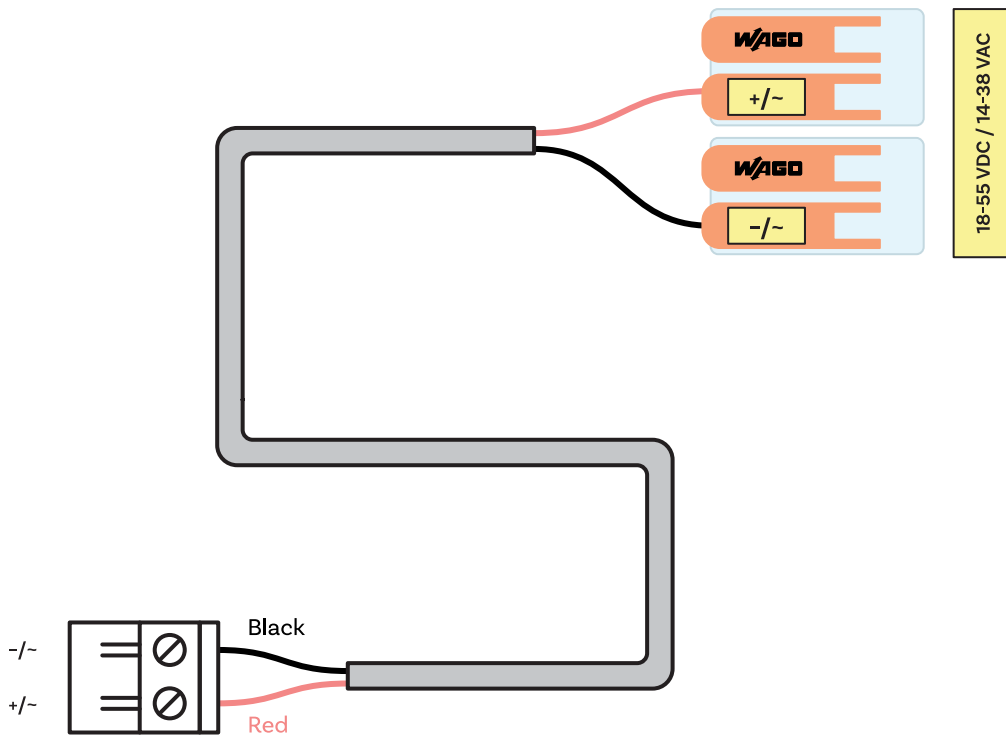

For VDISP Option

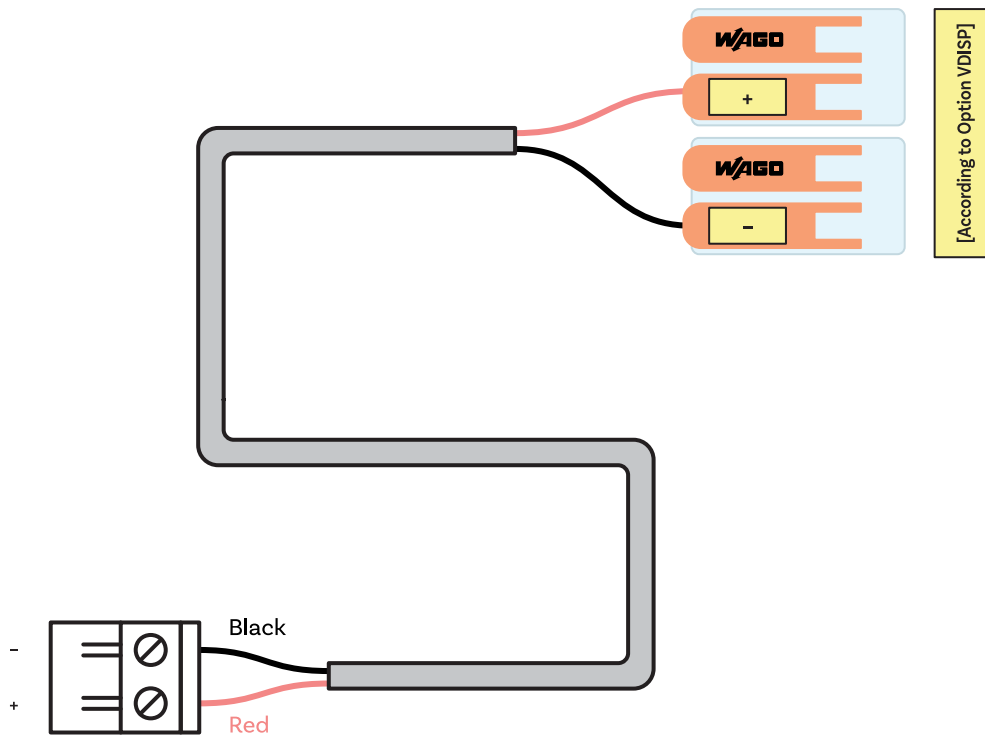

2.2.3. Cable Connection

LINES / DC OUT Wire Connection

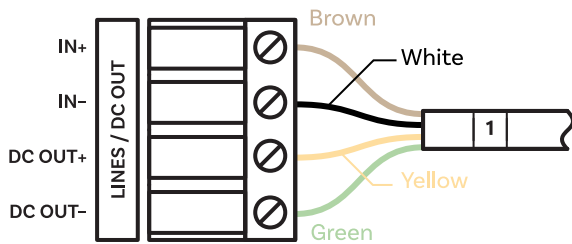

TEMP Wire Connection

One or two temperature sensors

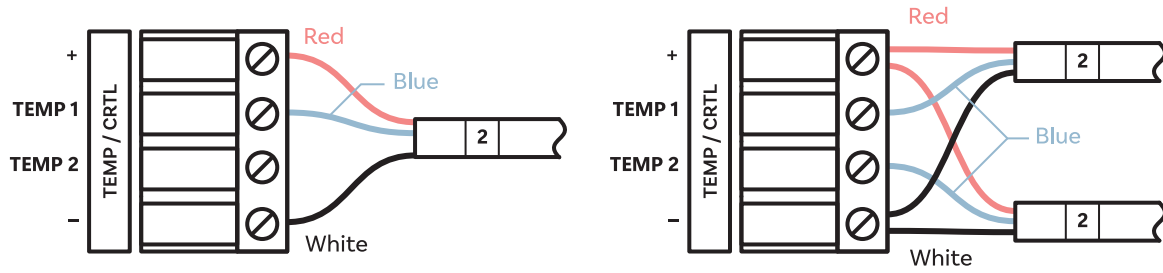

CTRL Wire Connection

Stopwatch control connects to TEMP connector

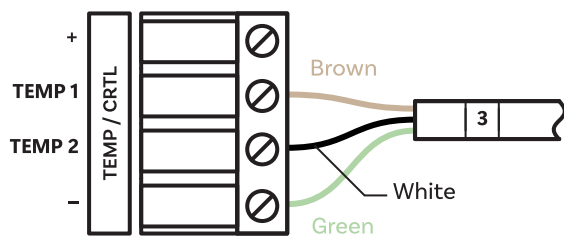

2.2.3.1. RS-485 Wire Connection

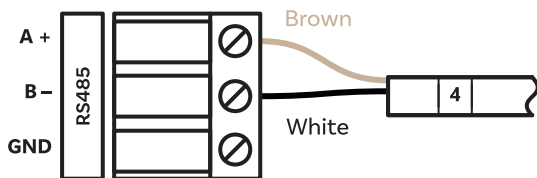

2.2.3.2. RELAY Wire Connection

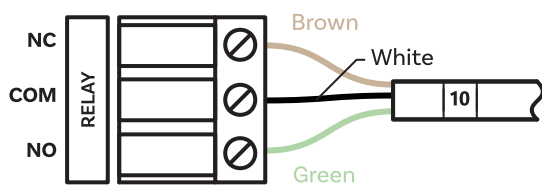

2.2.3.3. DC IN Connection

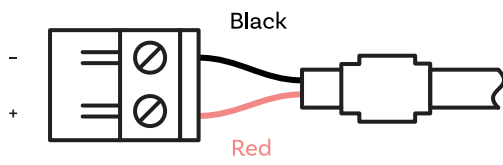

2.2.3.4. VDC or RP Option Wire Connection

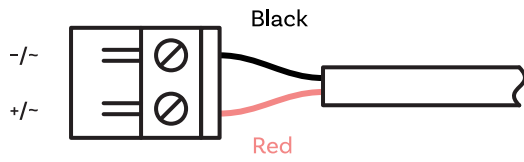

2.2.3.5. VDISP Option Wire Connection

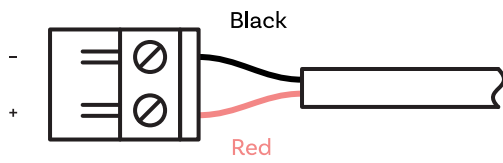

3 Clock Operation

These chapters give you detailed description of different clock operation modes.

- **Non-Network Clock Operation**
For digital clock synchronized by LGC, GPS variant or digital clock with RS-485 option.
- **Network Clock Operation**
For digital clock synchronized by NTP, PoE, PoE+, WiFi or WiFi5 variant.

3.1. Non-network Clock Operation

Depending on the synchronization source, it is necessary to configure the DIP switch on clock PCB - either to the DCF position or to the LINES position (default setting). The position of DIP switch is shown under letter **B** on PCB diagrams.



The correct position of the DIP switch must be set before connecting the line wiring to the LINES connector or before starting the synchronization line.

Enter the Type of synchronization setting (SYNC menu item o2) and set the desired type. The Auto-Detection Mode (SYNC menu item o2 set to value **A**) is applicable for DCF signal, MOBATIME serial code, IRIG-B. The permanently lit colon during the time display signalizes the clock is synchronized by the synchronization source.

3.1.1. DCF 77 Receiver

1. Configure the DIP switch to DCF position.

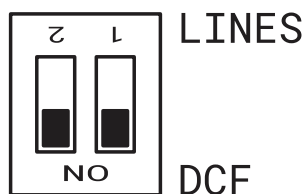

It is important to switch both positions to **ON** (DCF).

2. Set value **A** in SYNC menu items o1 (Timezone of Synchronization Source) , o2 (Type of Synchronization) and in DISP menu item d2 (Time Zone of Time and Date) .
3. Connect the DCF 77 receiver to the clock terminal board placed on the anchoring plate (LINE IN terminals) using a twin-wire cable.

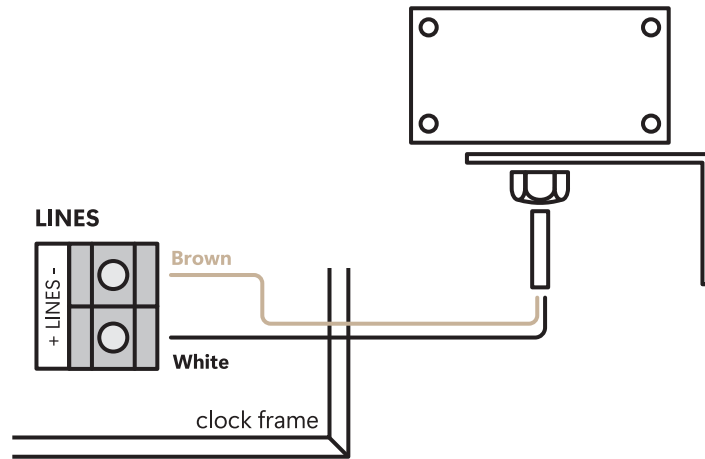

4. The maximum wire length depends on its diameter (approx. 100–300 m at 0.25 mm²).
5. In case the connection is correct and the input signal is at high level, the LED on the receiver is flashing periodically once a second with one pulse left out at the 59th second.



If the polarity is incorrect, the LED does not flash. In such case, interchange the two wires.

6. Install the receiver at a place with a high-level radio signal. Do not install the receiver near sources of interfering signals, such as personal computers, TV sets or other types of power consumers (the digital clock itself generates interfering signals too).
7. Position the receiver with its transparent cover (DCF 450) or the arrow on the cover (DCF 4500) facing the transmitter (located in Frankfurt, Germany). Presuming the good quality DCF 77 signal the synchronization takes place in approx. 3 to 4 minutes. In case of poor quality of the signal (mainly during the day time), the first time setting is to be done manually. The red LED of the receiver displays a working connection by flashing once a second without flickering.

3.1.2. GPS Receiver

1. Set value **A** in SYNC menu items o1 (Timezone of Synchronization Source) and o2 (Type of Synchronization) . Set your desired time zone in DISP menu item d2 (Time Zone of Time and Date) .
2. Connect the GPS antenna to SMA connector.

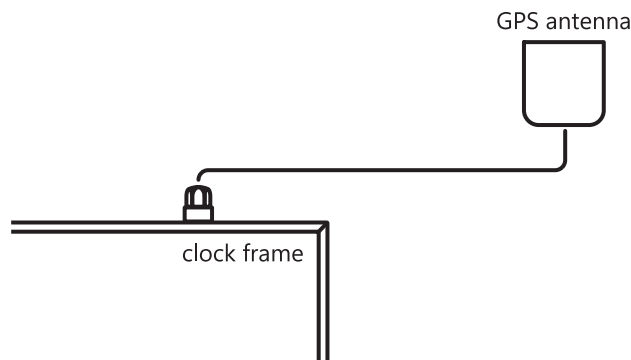

3. Presuming the good position of the GPS receiver the synchronization takes place in approx. 10 to 20 minutes.

3.1.3. GPS Receiver (GNSS 4500)

1. Configure the DIP switch to DCF position.

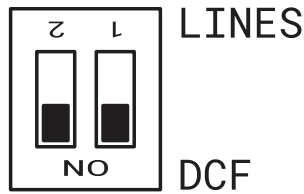

It is important to switch both positions to **ON** (DCF).

- Set value **A** in SYNC menu items o1 (Timezone of Synchronization Source) and o2 (Type of Synchronization) . Set your desired time zone in dISP menu item d2 (Time Zone of Time and Date) .
- Connect GPS receiver (GNSS 4500) to the clock terminal board placed on the anchoring plate (LINE IN and DC OUT terminals) using four-wire cable.



Please note the correct polarity of the wires – see the GPS user manual.

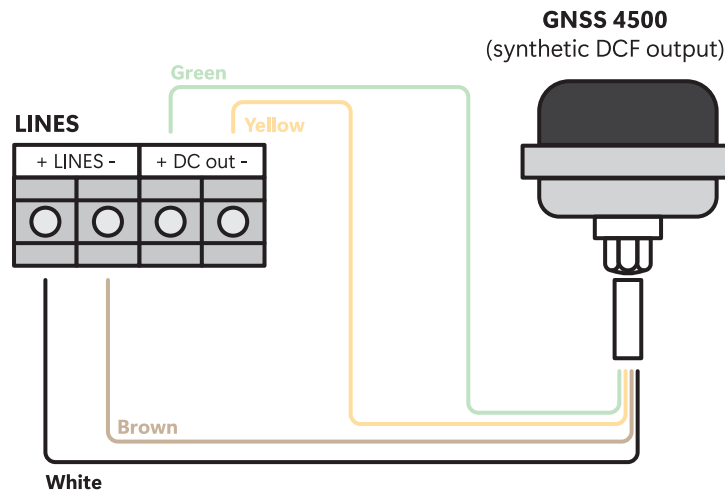

- For the correct placing of the receiver please follow the GPS user manual.
- Presuming the good position of the GPS receiver (GNSS 4500) the synchronization takes place in approx. 10 to 20 minutes. The green LED diode lights up.

3.1.4. Synchronizing Impulses

In a time distribution system, where the digital clocks are controlled by polarized impulses, choose the item **o2** in the SYNC menu and set the according type of the impulse line (one minute, half minute, second pulses).

- Configure the DIP switch to LINES position (default setting).

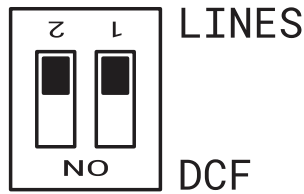

2. Set value **A** in SYNC menu items o1 (Timezone of Synchronization Source) and o2 (Type of Synchronization) . Set your desired time zone in dISP menu item d2 (Time Zone of Time and Date) .
3. The clock time-base is synchronized by incoming pulses in normal operation of the slave line.
4. Set current date and time in tIME menu according to **MASTER** clock with accuracy of ± 30 seconds (or ± 15 seconds, or ± 0.5 second respectively).
5. The colon flashes in 2 second interval.
6. After 2–3 minutes are the clocks synchronized with the **MASTER** clock. The colon is permanently lit during the display of time.
7. In case of the line fault, the clock displays the right time information based on its own quartz time base. When the normal operation of the line resumes, the clock synchronizes with the incoming pulses.

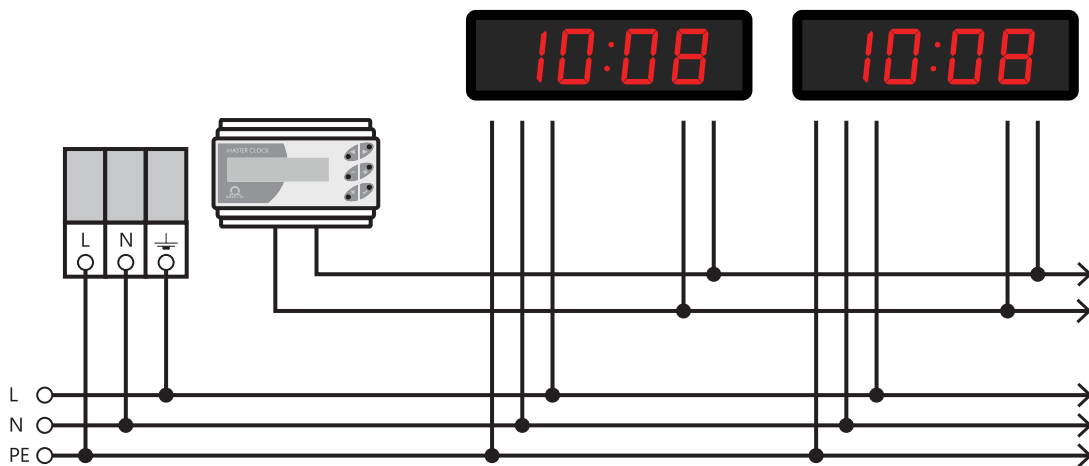

3.1.5. MOBATIME Serial Code, MOBALine or IRIG-B

1. Configure the DIP switch to LINES positon (default setting).

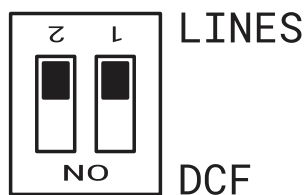

2. After connection of the digital clock to the signal source, time and date are adjusted automatically, following the receipt of valid time information.
3. The time setting with using the serial coded line takes place within at least 5 to 6 minutes, for MOBALine and IRIG-B within 6 to 15 seconds.

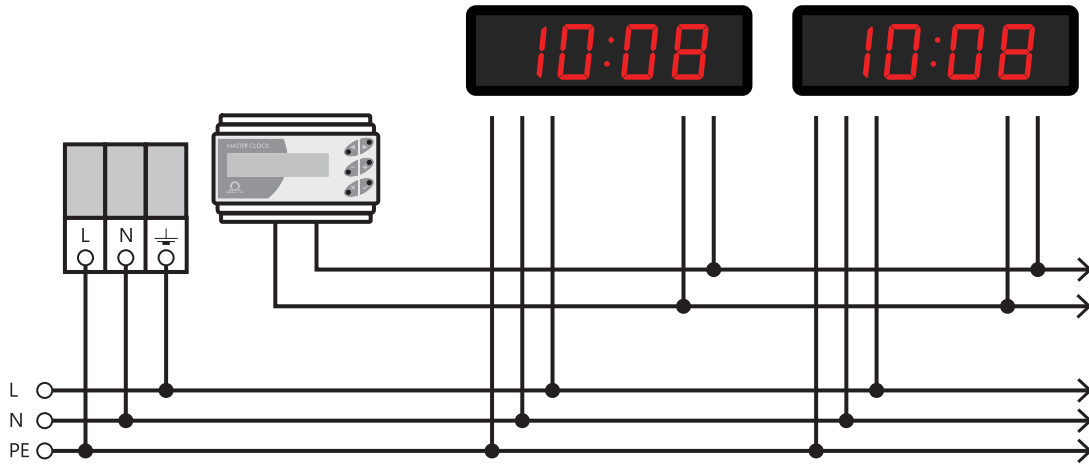

3.1.6. IF482 Control over RS-485



Only for RS-485 option.

1. After connection of the digital clock to the line, time and date are adjusted automatically, following the receipt of valid time information.
2. Setting the tune takes place within at least 5 minutes.

3.2. Network Clock Operation

Clock supports IPv4 and IPv6 protocols. You can disable individual protocols by setting values in IP mode in network settings. Default clock setting allows both protocols at the same time – NEt menu item n1 set to value 0 .



For IPv4 mode, DHCPv4 is enabled by default – NEt menu item n3 is set to value 1 .

IPv6 mode allows up to 4 different priority IP addresses in downwards order:

- DHCPv6
- manually configured IP address (fix)
- autoconfiguration (SLAAC / RA)
- local address link

For IPv6 mode, DHCPv6 and autoconfiguration (SLAAC) are enabled by default:



1. **DHCPv6** : NEt menu item n11 is set to value 1 .
2. **SLAAC** : NEt menu item n10 is set to value 1 .

Default Network Parameters

Parameter	Value(s)
IP Mode	IPv4 / IPv6
IPv4 Address	0.0.0.0
IPv4 Subnet Mask	0.0.0.0
IPv4 Default Gateway	0.0.0.0
NTP Server Address 1	0.0.0.0 / 0:0:0:0:0:0:0:0
NTP Server Address 2	0.0.0.0 / 0:0:0:0:0:0:0:0
NTP Server Address 3	0.0.0.0 / 0:0:0:0:0:0:0:0
NTP Server Address 4	0.0.0.0 / 0:0:0:0:0:0:0:0
NTP Request Time [s]	10
DNS Manager	0.0.0.0 / 0:0:0:0:0:0:0:0
SNMP Manager 1	0.0.0.0 / 0:0:0:0:0:0:0:0
SNMP Manager 2	0.0.0.0 / 0:0:0:0:0:0:0:0
Multicast Config Address	239.192.54.1 / FF38::EFC0:3601 (FF38:239.192.54.1)
Alive Notifications Interval [min]	30
Configuration Port Number	65532
Timezone Client Port Number	65534
DHCPv4	enabled
SNMP	enabled
Multicast Support	enabled
IPv6 Fix Address / Prefix	0:0:0:0:0:0 / 64
IPv6 Link Local Address	fe80 :: 2 [2 nd octet MAC]: [3 rd octet MAC] ff: fe [4 th octet MAC]: [5 th octet MAC] [6 th octet MAC]
DHCPv6	enabled
Autoconfiguration (SLAAC)	enabled
Web Server	enabled
Web Server Password	mobatime

3.2.1. Unicast Mode

The clock is synchronized to UTC (*Coordinated Universal Time*) from NTP server (up to four IPv4 / IPv6 addresses for NTP server configurable) and **must** have assigned its own IPv4 / IPv6 address. The clock requests in defined intervals the actual time from NTP

server (interval can be adjusted in NEt menu item n9). If the server is not available, the clock tries to contact other defined servers in cyclic ways until valid response from NTP server is received.

This operation mode supports monitoring and configuration of movement via network connection by means of **Web Interface** (enabled in NEt menu item n15 setting the value to 1), **SNMP** (enabled in NEt menu item n14 setting the value to 1) or **MOBA-NMS Software Tool** .

For supervision and configuration with MOBA-NMS, either clock’s IPv4 / IPv6 address can be used or multicast group address (NEt menu item n7) must have last octet cleared to zero (presuming that the multicast is not disabled – NEt menu item n13 is not set to value 0).

It is necessary to set appropriate timezone for correct displaying of local time and date. More details can be found in:



- Local time calculation according to internal timezone table
- Local time calculation using time zone server MOBATIME
- Local time calculation using time zone entries preconfigured by MOBA-NMS software

3.2.2. Multicast Mode

The clock is synchronized to UTC (Coordinated Universal Time) from NTP server. The clock receives NTP multicast packets transmitted by NTP server in specified time cycle. This type of synchronization requires no clock’s own IP address and is therefore suitable for easy commissioning of large systems of **SLAVE** clocks. Further this mode supports monitoring and parameter configuration by means of MOBA-NMS software.

For supervision and configuration with MOBA-NMS, either multicast group address can be used or multicast group address having last octet cleared to zero.

It is necessary to set appropriate timezone for correct displaying of local time and date. More details can be found in:



- Local time calculation according to internal timezone table
- Local time calculation using time zone server MOBATIME
- Local time calculation using time zone entries preconfigured by MOBA-NMS software

Default Network Parameters

Parameter	Value(s)
IPv4 Multicast Group Address	239.192.54.1
IPv4 Multicast Config Address	239.192.54.0
IPv6 Multicast Group Address	FF38::EFC0:3601 (FF38::239.192.54.1)
IPv6 Multicast Config Address	FE38::EFC0:3600 (FF38::239.192.54.0)
Configuration Port Number	65532
Timezone Client Port Number	65534



NEt menu item n2 (Configuration Mode) must be set to value 1 .

3.2.3. Network Parameters Assigned by DHCPv4

IP clock mode must be set to IPv4 mode (can be set in NEt menu item n1 setting the value either to 0 or 1). The NEt menu item n3 (DHCPv4 Mode) **must** be set to value 1. Network parameters are automatically obtained from a DHCPv4 server.

The following DHCP options will be evaluated automatically:

[50]:	IP address
[3]:	gateway address
[1]:	subnet mask
[42]:	list of up to four NTP server addresses / time zone address (usually same as NTP server address)
[6]:	DNS server
[26]:	MTU
[60]:	vendor Class ID
[43] or [223]:	additional options (refer to document BE-800793)



The network administrator must configure DHCPv4 options accordingly. Assigned parameters can be checked in submenu of NEt menu items n4 to n6.

3.2.4. Manual Settings through Setup Menu



DHCPv4 must be disabled – navigate to DHCPv4 mode (NEt menu item n3) and set the value to 0.

To manually set all clock network parameters listed in table below:

Menu Item	Description
n4	Setting of Clock's IP Address
n5	Setting of Subnet Mask
n6	Setting of Default Gateway
n7	Setting of Multicast Group Address
n8	Setting of Unicast NTP Server Address

3.2.5. Calculation of Link Local Address

fe80 :: 2 [2nd octet MAC]: [3rd octet MAC] ff: fe [4th octet MAC]: [5th octet MAC] [6th octet MAC]



MAC:

00: 16 : 91 : 12 : 34 : 56

IPv6:

fe80 :: 2 16 : 91 ff: fe 12 : 34 56

3.2.6. Setting Network Parameters over Autoconfiguration (SLAAC)

IP clock mode must be set to IPv6 mode (can be set in NEt menu item n1 setting the value either to 0 or 2). The NEt menu item n10 (Address Autoconfiguration) must be set to value 1. Network parameters are automatically retrieved from a DHCPv6 server.

The following SLAAC options can be processed:

- [3] : prefix info
- [5] : MTU
- [24] : route info
- [25] : RDNSS



The network administrator must configure SLAAC options accordingly.

3.2.7. Setting Network Parameters over DHCPv6

IP clock mode must be set to IPv6 mode (can be set in NEt menu item n1 setting the value either to 0 or 2). The NEt menu item n11 (DHCPv6 Mode) must be set to value 1 . Network parameters are automatically retrieved from a DHCPv6 server.

The following DHCPv6 options can be processed:

- [3] : Identity Association for Non-temporary Addresses (IA_NA)
- [16] : vendor class
- [17] : vendor options
- [23] : DNS servers
- [24] : DNS domains
- [25] : identify association for prefix delegation
- [31] : SNTP servers



The network administrator must configure DHCPv6 options accordingly.

3.2.8. SNMP

The clock supports SNMP version 1, version 2c and version 3 for reading and setting parameters using SNMP GET and SET commands. Only SNMP v2c is supported for SNMP trap notification.

SNMP support allows the clock to be integrated into the system for monitoring network elements. The clock (SNMP agent) can send alarms or notifications to the SNMP manager. The IP address of the SNMP manager can be set in the clock via DHCP, web interface, SNMP or MOBA-NMS.

The supported SNMP protocol version and other necessary parameters for user authentication and communication encryption can be set in the clock via the web interface, SNMP or MOBA-NMS. The SNMP version can be set in combinations:

- v3, v2c, v1
- v3, v2c
- v3
- v2c, v1

The structure of the supported parameters is defined in the MIB file (see document TE-800728 or BE.800793 for more information, on request). In addition, the clock supports the parameters defined by the "system" node in the MIB-2 definition (RFC-1213). Alarm notifications are asynchronous messages and are intended to inform the SNMP manager about the occurrence or disappearance of an alarm. Alive notifications are sent periodically to inform about availability and clock status. The sending interval can be set.

Alarm notifications are asynchronous messages and are intended to inform the SNMP manager about the occurrence or disappearance of an alarm.

3.2.8.1. Default SNMPv2c Community Strings

Type of Community	Default Value
Read Community	romobatetime

Type of Community	Default Value
Read / Write Community	rwmobatime
Notifications (Trap) Community	trapmobatime

3.2.8.2. SNMPv3

SNMPv3 includes user authentication and communication encryption. Security is provided using a Security name, Authentication password, and Privacy password. During authorization, communication can be encrypted using MD5 or SHA (SHA-1), and the actual communication can be encrypted using DES or AES (AES 128). The security level can be configured.

The clock allows you to set up two user profiles with different access rights within SNMPv3. Each user has their own combination of Security name, Authentication password and Privacy password along with the appropriate encryption and access rights, which together form a profile.

Default parameters for SNMPv3 USM Profile 1

Parameter	Value
Security Name	admin
Security Level	authentication, privacy
Authentication Protocol	SHA
Authentication Password	rwmobatime
Privacy Protocol	AES
Privacy Password	rwmobatime
Access Control	read & write

Default Parameters for SNMPv3 USM Profile 1

Parameter	Value
Security Name	user
Security Level	authentication, privacy
Authentication Protocol	SHA
Authentication Password	romobatime
Privacy Protocol	AES
Privacy Password	romobatime
Access Control	read only

3.2.8.3. Web Interface

Overview

Network

Time

Time zone

Mode

Sensors

Supervision

General

Command

Authentication

Logout

Supervision

SNMP

Notification manager 1

Notification manager 2

Alive notification send interval min

Enabled versions

SNMPv2c parameters

Read community string

Write community string

Trap community string

SNMPv3 USM Profile 1

Security name

Security level

Authentication protocol

Authentication password

Privacy protocol

Privacy password

Access control

SNMPv3 USM Profile 2

Security name

Security level

3.2.9. HTTPS

The web interface of the digital clock is accessible from a web browser via HTTP and HTTPS protocols. The clock is supplied with a pre-made certificate for secure communication via HTTPS protocol. The certificate is not backed by a certificate authority, so the web browser will display a warning that the connection is not private. In this case, you need to accept this condition and continue on to the website.



Certificates are provided in the manufacturer process since firmware version r7.15. In case of firmware update from earlier version, you need to upload SSL certificate by your own.

The default password for the web interface is *mobatime*. The password can be changed via the web interface, MOBA-NMS and SNMP. You can also use mDNS on your local network. You can use the hostname of the digital clock and use it with the .local extension instead of the IP address. The hostname is composed of the word MOBATIME and the last 3 octets of the MAC address.

	MAC address :	00:16:91:12:34:56
	↓	
	Hostname :	MOBATIME123456
	Enter to address bar :	http://mobatime123456.local or https://mobatime123456.local

The web interface mode can be set in the web interface – Supervision tab. Combinations can be set:

- HTTP and HTTPS
- HTTP only
- HTTPS only
- HTTP redirect to HTTPS

User certificates can be uploaded to the clock using the tftp protocol. The certificate files need to be named:

- **key.pem** : private key
- **cert.pem** : certificate
- **ca.pem** : certificate of certification authority

To upload files , use the HTTPS server certificate upload option to select each file type in turn. Press the Apply button to start the upload.

To apply user certificates , under HTTPS server certificate manage, select *Apply user certificates* , and then click **Apply** .

To delete user certificates , set this entry to *Apply factory certificates (delete user certificates)* and confirm with **Apply** . After the clock restarts, the new certificate will be used.

3.2.10. WiFi Operation Modes



Available only for WiFi or WiFi5 variant.

WiFi Operation Modes can be set in NEt menu item 12 (WiFi Mode) .

3.2.10.1. Station Mode (User Defined)

- Connecting to a user-defined WiFi network.
- The WiFi network is defined via MOBA-NMS software tool or Web Interface.

3.2.10.2. Station Mode (MOBA-WIFI)

- Connecting to WiFi with SSID **MOBA-WIFI** .
- Uses WPA2-PSK encryption with default password **hgfedcba** .
- Other network parameters are set according to current settings.

3.2.10.3. AP Mode

- Creates a WiFi AP (Access Point) on 2.4 GHz with SSID **MOBAxxxxxxxxxx** where **xxxxxxxxxx** is MAC address of specific clock.
- Default encryption WPA2-PSK with default password **password** .
- Active internal DHCP server, **192.168.2.0** network with an allocated range of **.100** to **.254** .
- Clock are accessible at static address **192.168.2.1** .



AP mode will disable DHCP on the clock and the clock will operate on static IP address. When switching back to Station mode, manually re-enable DHCP if required or reconfigure static IP address.

- Configuration via web interface only (due to password entry).





4 Settings

These chapters provide instruction and information on how to configure and customize various features and settings of the digital clock. It helps users set up the clock according to their preferences and needs.

4.1. Control

The clock is set and controlled by two push-buttons or by remote controller. Position of push-buttons depends on the clock type. Push-buttons are mostly located on the upper side of the frame.







4.1.1. Push-buttons

Button	Description	Function
	Push-button 1 (short press)	<ul style="list-style-type: none"> Moving "up" in menu / submenu Decreasing of set value
	Push-button 1 (long press)	<ul style="list-style-type: none"> Exit from menu / submenu / set value Exit without saving
	Push-button 2 (short press)	<ul style="list-style-type: none"> Moving "down" in menu / submenu Increasing of set value
	Push-button 2 (long press)	<ul style="list-style-type: none"> Entry into menu submenu / set value Save and exit
 ^[1]	Push-button 3 (long press)	<ul style="list-style-type: none"> Entry into stopwatch display



Long press is activated if the push-button is pressed for longer than 1 second.

4.1.2. Remote Controller Buttons

Button	Function
	<ul style="list-style-type: none"> Moving "up" in menu / submenu Exit from stopwatch display into main screens
	<ul style="list-style-type: none"> Moving "down" in menu / submenu
	<ul style="list-style-type: none"> Exit from menu / submenu / set value Exit without saving
	<ul style="list-style-type: none"> Entry into menu / submenu / set value Save and exit
	<ul style="list-style-type: none"> Entry into menu from mains screens Entry into menu from stopwatch display
	<ul style="list-style-type: none"> Entry into stopwatch display from main screens

Button	Function
CLOCK	• Exit from stopwatch display into clock display
DATE	• Exit from stopwatch display into date / calendar week display
TEMP	• Exit from stopwatch display into temperature display
-	• Decreasing of set value
+	• Increasing of set value

[1] Available only on stopwatch keyboard accessory.

4.2. Navigation scheme

- Control of the clock using push-buttons placed on the clock is marked in **blue frame with blue text** .
- Control of the clock using the buttons on remote controller buttons is marked in **orange frame with orange text** .

4.2.1. Navigation using push-buttons

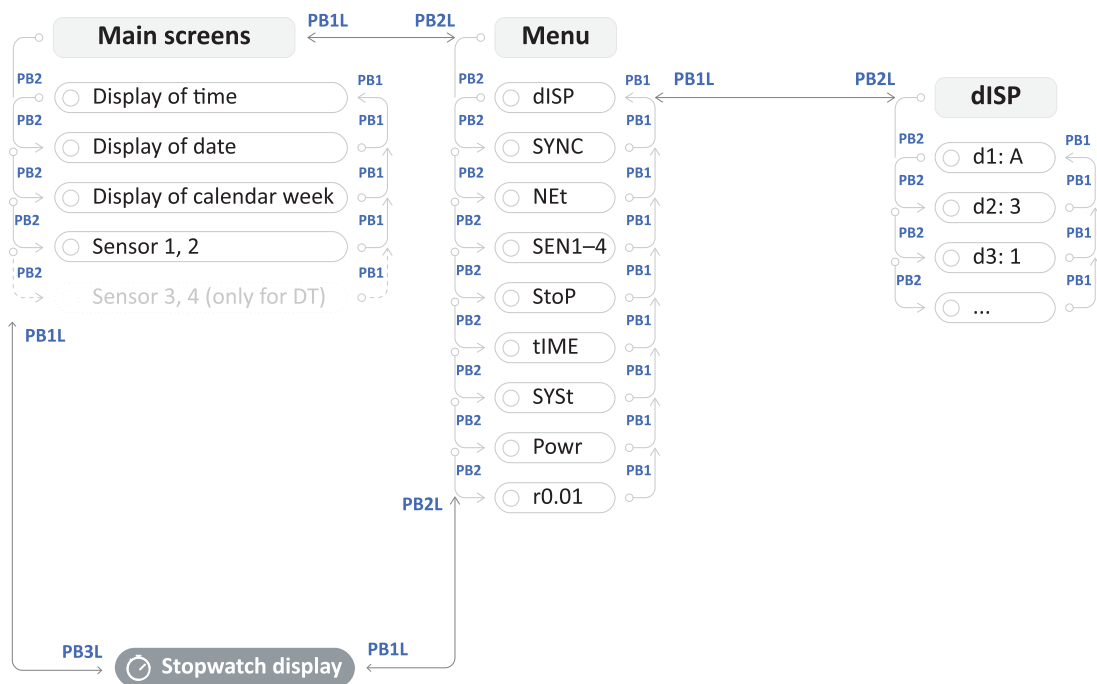

4.2.1.1. Example of dISP submenu setting

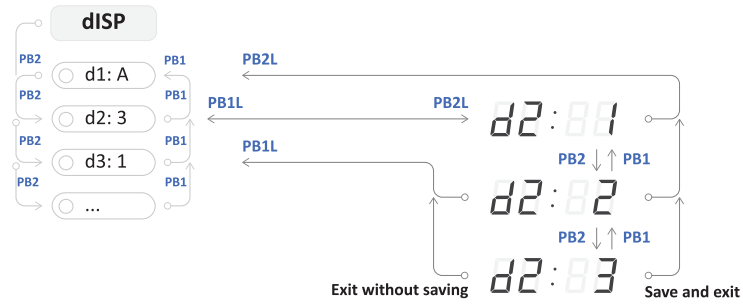

4.2.1.2. Example of NEt submenu setting

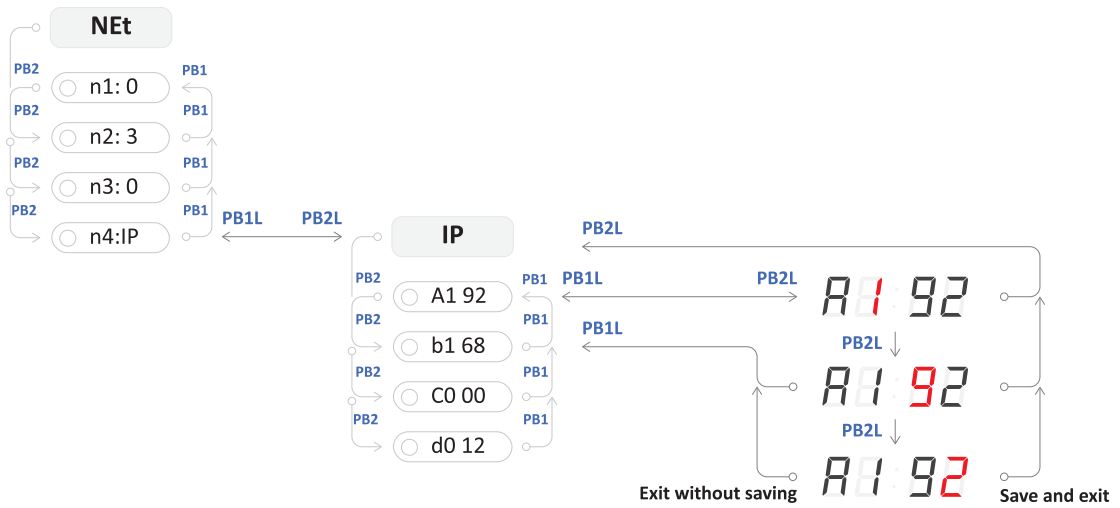

4.2.2. Navigation using remote controller

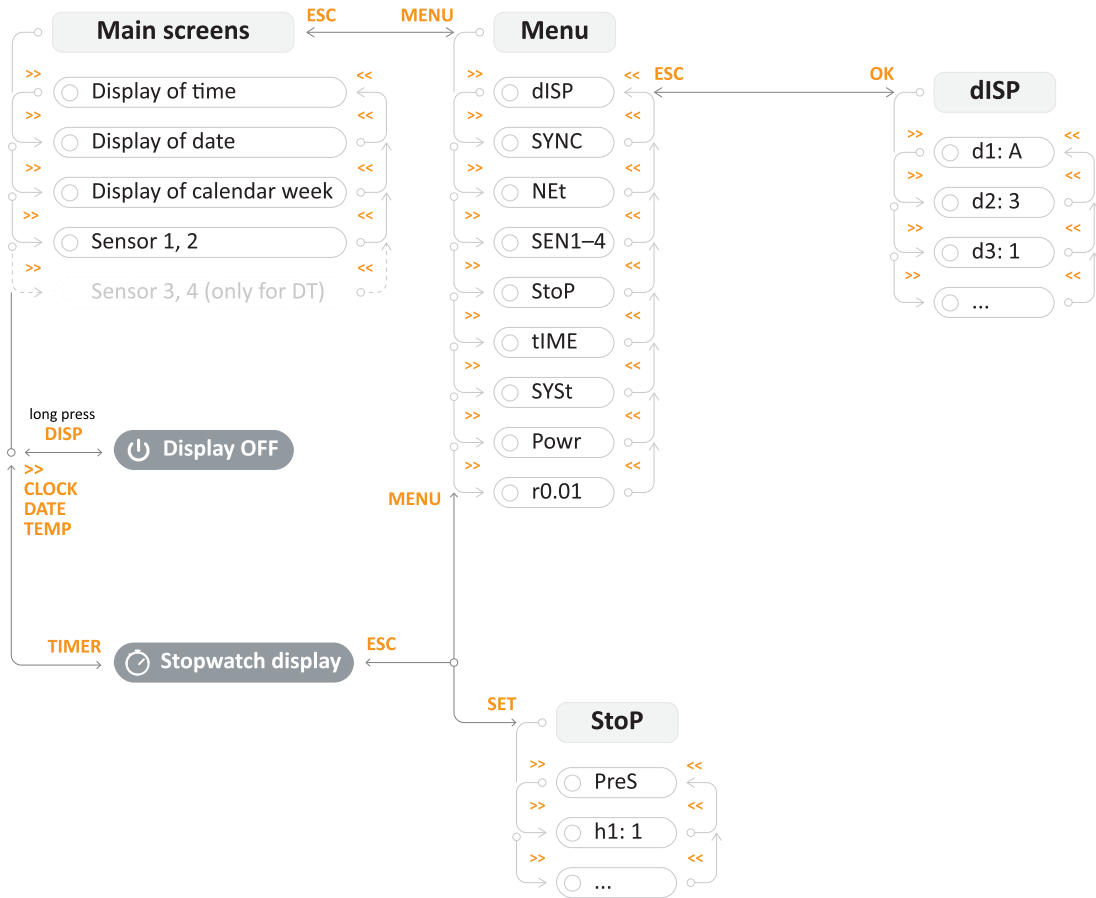

4.2.2.1. Example of dISP submenu setting

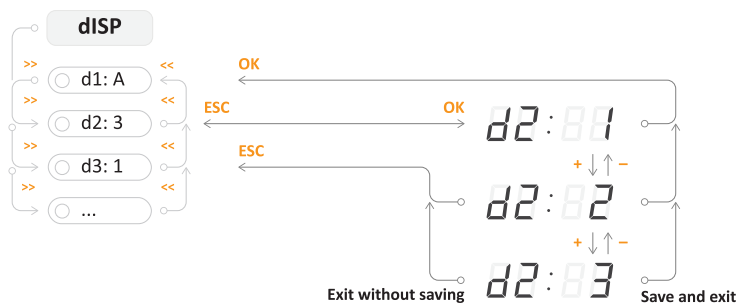

4.2.2.2. Example of NEt submenu setting

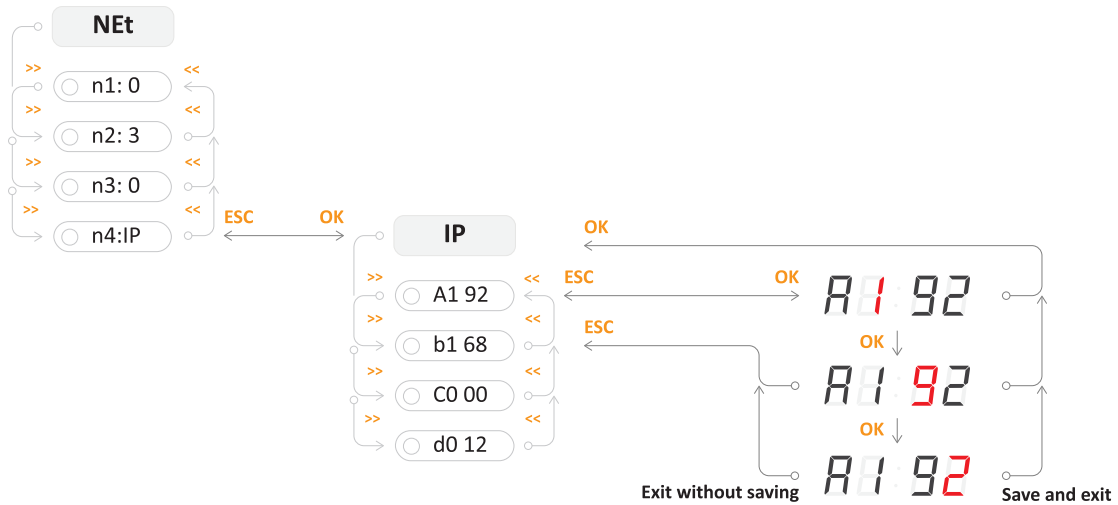

4.3. Web Interface

The web interface for this digital clock configuration tool is designed to provide users with a seamless and customizable experience in setting up their preferred digital timepiece directly within their browser.

4.3.1. How to Access the Web Interface?

To access the web interface of the clock, you first need to know its IP address. Please follow these steps to view the IP address of the clock:

Step 1 – Enter NEt menu

- Press **PB2L** on digital clock or **MENU** on remote controller to enter main menu of the clock.
- Press **PB2** on digital clock or **>>** on remote controller to navigate to NEt menu.



Step 2 – Navigate to n4:IP item

- Press **PB2** on digital clock or **>>** on remote controller to navigate through NEt menu items until you reach the n4:IP item.
- Press **PB2L** on digital clock or **OK** on remote controller to enter the n4:IP item.



Step 3 – View the IP Address of the Clock

- To navigate between octets, use **PB2** push-button on digital clock or **>>** button on remote controller.

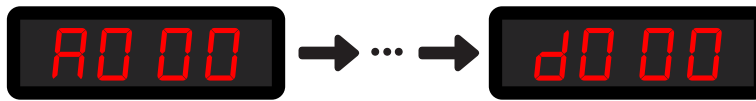

Step 4 – Accessing the Web Interface

- Open up your web browser and type the IP address into search bar.

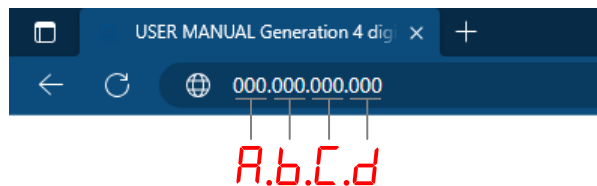

- Login page will appear. Default password is **mobatime**.

4.3.2. Generate SSL Certificate

For access to the digital clock via secured web pages - https it is necessary to burn SSL certificate directly to the digital clock. Clocks are provided with a factory certificate which is generated during the manufacturer process.



More info about accessing the Web Interface from web browser via HTTP and HTTPS protocols can be found in **Clock Operation > Network Clock Operation > HTTPS Chapter**.

Certificates are provided in the manufacturer process since SW version **v7.12**. In the case of updating SW version in the digital clock from earlier versions, there will be an active alarm **Invalid SSL certificate**. So it is necessary to upload an SSL certificate by your own.

Certificates required:

- RSA 2048 bit
- Fingerprint using SHA-256

4.3.2.1. Generate Certificate

You can use any method to generate certificates.

If you are unfamiliar with the process of certificate generation, you may utilize this website.

- Visit CertificateTools.com.

CertificateTools.com Revocation Generators

CertificateTools.com X509 Certificate Generator

Use Existing Certificate as a Template Web Server

Private Key

Generate PKCS#8 RSA Private Key 2048 Bit

Encrypt

Subject Attributes

Add / Remove Attributes

Common Names

MOBATIMEFD306F Add

Add a common name

Country

CZ

State

South Moravian

Locality

Vyškov

Organization

Acme Inc.

Subject Alternative Names

DNS MOBATIMEFD306F Add

Add a subject alternative name

x509v3 Extensions

OCSP Must-Staple

Key Usage

Extended Key Usage

Basic Constraints (CA)

Encoding Options

Default

CSR Options

SHA256 Self-Sign

30 Year(s)

Submit

- On the top right list please select option **Web Server** (marked by blue).
- To the columns **Common Names** (marked by red), please type requested name of the subject and click **Add** .
 - For example `MOBATIMEFD306F` is used for the MAC address `00:16:91:fd:30:6f` in the manufacturer process.
- To the column **Subject Alternative Names DNS** (marked by yellow), please type requested name of the subject and then click **Add** .
The requested name of the subject can be:
 - `MOBATIMEFD306F` (as stated above)
 - `MOBATIMEFD306F.local`
 - IP address
- In the CSR Options please set CSR Only to the **Self-Sign** (marked by purple) and type requested validity of certificate, e.g. 30 years.
- Optionally, you can also set other fields.
- Then click **Submit** .
- The web page will generate a certificate.
- Download files **Private Key** and **PEM Certificate** .

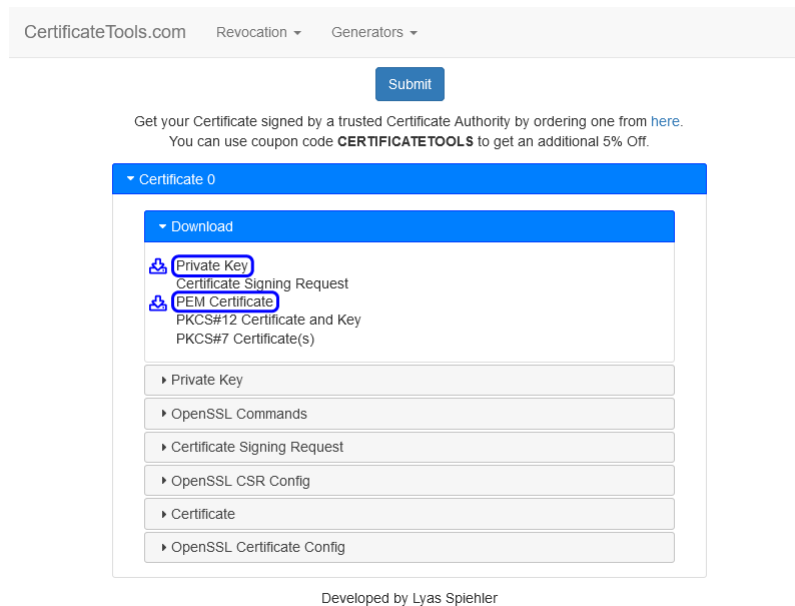

You can also use these instructions if you want to generate different SSL certificates.

4.3.2.2. Uploading a Certificate

1. Rename file `cert.key` (Private Key) to `key.pem` .
2. Rename file `cert.crt` (PEM Certificate) to `cert.pem` .
3. Copy these files to the folder for your TFTP server.
4. On the web page of digital clock navigate to section **Supervision Services** .
5. Set the field **HTTPS server certificate upload** to **Private Key** and press **Apply** .
It should display `Configuration saved` and the Private Key should be uploaded.
6. Set the field **HTTPS server certificate upload** to the **Certificate** and press **Apply** .
It should display `Configuration saved` and the Certificate should be uploaded.

4.3.2.3. Certificate Application and Managing

Apply a New Certificate

1. Set the field **HTTPS server certificate manage** to the **Apply user certificates** and press **Apply** .
It should display `Configuration saved` and a new certificate should be uploaded.

Delete User Certificate

1. Set the field **HTTPS server certificate manage** to the **Apply factory certificates (delete user certificates)** and press **Apply** .
It should display `Configuration saved` and user certificates should be deleted.

4.3.3. Overview Tab

This is the front page of web interface. Here you can see system basic system information such as Device type, description, Firmware version, Time, MAC and IPv4 address.

Nothing at this tab cannot be edited.

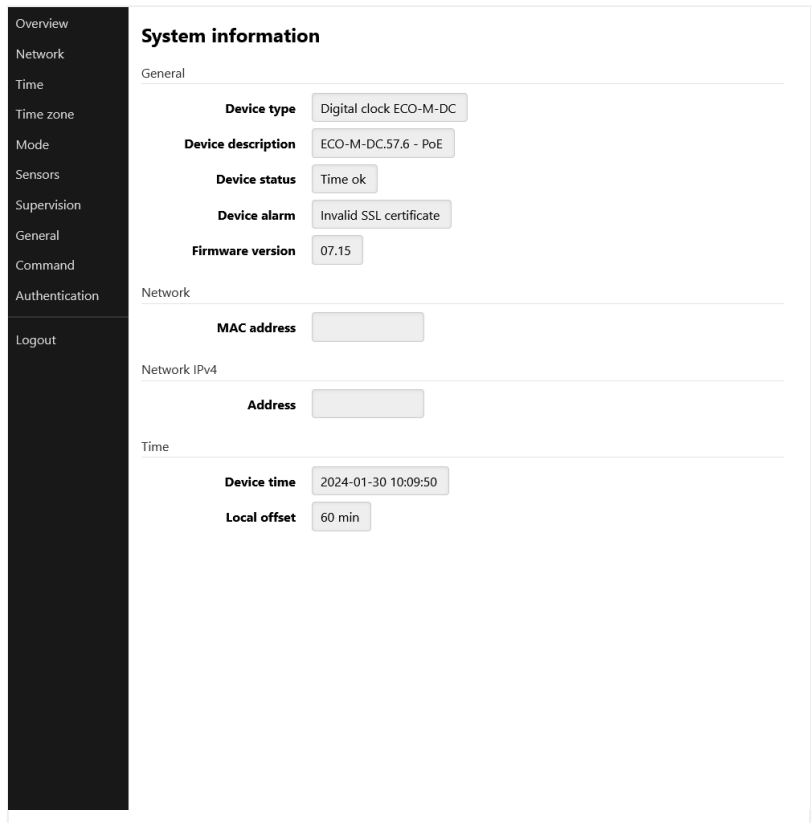

4.3.4. Network Tab

This tab serves as network setting of clock parameters. You can almost set any network-related settings, such as IP mode, multicast enable or disable, IPv4 and IPv6 address, even Timezone client port.

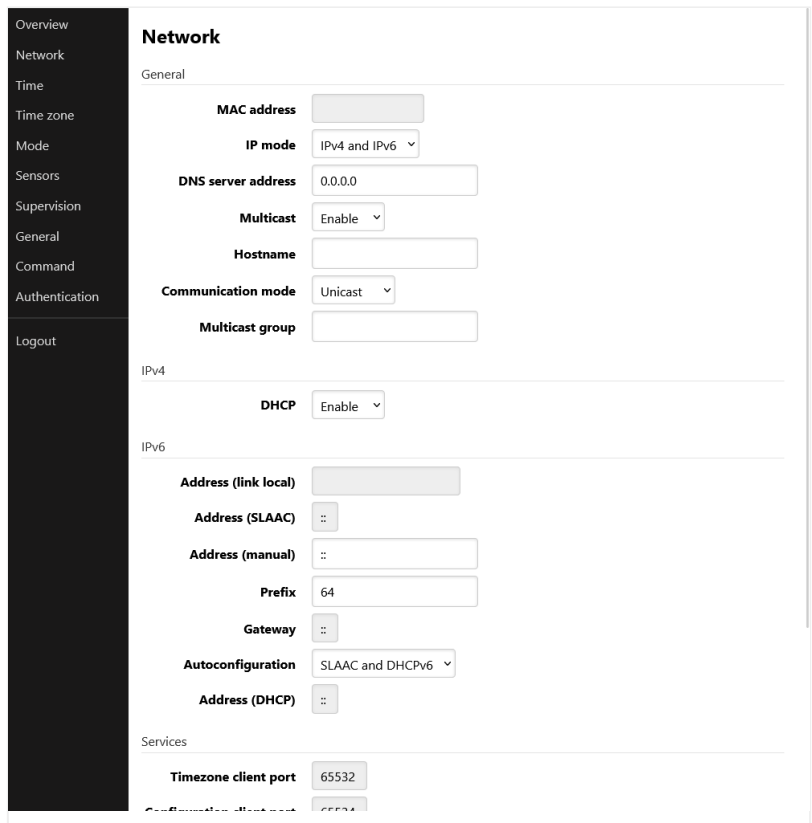

4.3.5. Time Tab

- Overview
- Network
- Time
- Time zone
- Mode
- Sensors
- Supervision
- General
- Command
- Authentication
- Logout

Time

General

Current NTP server

Device time 2024-01-30 10:12:03

Local offset 60 min

Last sync 2024-01-30 10:12:02

Timeout to indicate no sync h

NTP

Server address 1

Server address 2

Server address 3

Server address 4

Poll interval s

4.3.6. Time Zone Tab

- Overview
- Network
- Time
- Time zone
- Mode
- Sensors
- Supervision
- General
- Command
- Authentication
- Logout

Time zone

General

Entry selection ▾

4.3.7. Mode Tab

- Overview
- Network
- Time
- Time zone
- Mode
- Sensors
- Supervision
- General
- Command
- Authentication
- Logout

Mode

General

Display brightness Auto ▾

Time display format 24 ▾

Display alternating mode Continuous display time ▾

IR auto lock time U ▾

Time display zeros Yes ▾

Date display zeros No ▾

Display current derating -50% ▾

Light measurement correction -50% ▾

Stopwatch keyboard connected No ▾

Display alternating mode - display intervals

Time 6 s ▾

Date 3 s ▾

Calendar week off ▾

Temperature 1 off ▾

Humidity 1 off ▾

Pressure 1 off ▾

Temperature 2 off ▾

Humidity 2 off ▾

Pressure 2 off ▾

Power

4.3.8. Sensors Tab

- Overview
- Network
- Time
- Time zone
- Mode
- Sensors
- Supervision
- General
- Command
- Authentication
- Logout

Sensors

General

Supported types TP3/30, TPH 1m

Sensor 1

Type TP3/30 ▾

1-Wire input TEMP 1 ▾

Sensor 1: Temperature

Correction 0 ±10 °C

Display units Enable ▾

Unit °C ▾

Sensor 2

Type TP3/30 ▾

1-Wire input TEMP 2 ▾

Sensor 2: Temperature

Correction 0 ±10 °C

Display units Enable ▾

Unit °C ▾

Apply

4.3.9. Supervision Tab

- Overview
- Network
- Time
- Time zone
- Mode
- Sensors
- Supervision
- General
- Command
- Authentication
- Logout

Supervision

SNMP

Notification manager 1

Notification manager 2

Alive notification send interval min

Enabled versions v3, v2c, v1 ▾

SNMPv2c parameters

Read community string

Write community string

Trap community string

SNMPv3 USM Profile 1

Security name

Security level Auth, Priv ▾

Authentication protocol SHA (SHA-1) ▾

Authentication password

Privacy protocol AES (AES128) ▾

Privacy password

Access control Read & write ▾

SNMPv3 USM Profile 2

Security name

Security level Auth, Priv ▾

4.3.10. General Tab

- Overview
- Network
- Time
- Time zone
- Mode
- Sensors
- Supervision
- General
- Command
- Authentication
- Logout

General

General

Device type Digital clock ECO-M-DC

Device description ECO-M-DC.57.6 - PoE

Firmware number

Firmware version 07.15

Device status Time ok

Device alarm Invalid SSL certificate

Bootloader number

Bootloader version 03.00

4.3.11. Command Tab

Command

General

Software reset

Factory reset

Firmware update

Apply

4.3.12. Authentication Tab

Authentication

General

HTTP password

Apply

5 Display Settings

Display Settings Summary

Menu Item	Description	Value(s)
d1	Display Brightness	1–30, A
d2	Time Zone of Time and Date	0–64, A , U1–U7
d3	Time Constants	1 , 2, 3, 4, 5, 6, U, 0
d4	12-Hour Format	0 , 1
d5	Time with Leading Zero	0 , 1
d6	Date with Leading Zero	0 , 1
d8	Clock Address for IR Remote Controller Moved to SYST menu since version r7.15	1–99
d9	IR Remote Controller Auto-Lock Moved to SYST menu since version r7.15	1–60, U
10	Display of Time (User Defined)	0–60 (seconds)
11	Display of Date (User Defined)	0–60 (seconds)
12	Display of Calendar Week (User Defined)	0–60 (seconds)
13	Display of Temperature 1 (User Defined)	0–60 (seconds)
14	Display of Humidity 1 (User Defined)	0–60 (seconds)
15	Display of Pressure 1 (User Defined)	0–60 (seconds)
16	Display of Temperature 2 (User Defined)	0–60 (seconds)
17	Display of Humidity 2 (User Defined)	0–60 (seconds)
18	Display of Pressure 2 (User Defined)	0–60 (seconds)

Default values are in **bold**.

5.1. Display Brightness



Menu : DISP
Item : d1
Values : 1–30, **A**

Display brightness setting allows you to customize the luminance of the display. Brightness level is defined by numerical values or by sensor controlled automatic adjusting.

You can choose from range of values:

Value(s)	Description
1–30	lower value means lower brightness, higher value higher brightness
A (default value)	automatic brightness

5.2. Timezone of Time and Date



Menu :	dISP
Item :	d2
Values :	0–64, A , U1–U7

Timezone of displayed time and date refers to geographical region or offset from UTC (that is used as a reference point for displaying the current time and date). Timezone is crucial aspect of timekeeping and helps ensure consistency and accuracy in communication, scheduling and record-keeping.

You can choose from range of values:

Value(s)	Description
0–64	Timezone entries, see timezone table
A (default value)	Automatically set timezone
U1–U7	Preconfigured timezone from MOBA-NMS software

5.3. Time Constants



Menu :	dISP
Item :	d3
Values :	1, 2, 3, 4, 5, 6, U, 8, 0

This settings allows to choose the displayed data together with or without automatic switching over to next data. The time sequence of corresponding figures can be user-defined or predefined time sequence can be used.

You can choose from range of values:

Value(s)	Description
1 (default value)	Continuous display of time
2	Continuous display of date
3	Continuous display of temperature
4	Continuous display of stopwatch
5	Display sequence: time 6 s, date 3 s
6	Display sequence: time 8 s, date 3 s, temperature 3 s
U	Time constants set up by user in seconds for each specific displayed data see time constants
8	continuous display of shared screen
0	Automatic switching over is disabled

5.3.1. User-Defined Time Constants



Menu : dISP
Item : 10, 11, 12, 13, 14, 15, 16, 17, 18
Values : 0-60 (seconds)

Here you can customize your desired time constants:

Menu item	Function	Values
10	Display of time	0-60 (seconds)
11	Display of date	0-60 (seconds)
12	Display of calendar week	0-60 (seconds)
13	Display of temperature 1	0-60 (seconds)
14	Display of humidity 1	0-60 (seconds)
15	Display of pressure 1	0-60 (seconds)
16	Display of temperature 2	0-60 (seconds)
17	Display of humidity 2	0-60 (seconds)
18	Display of pressure 2	0-60 (seconds)

5.4. 12-Hour Format



Menu : dISP
Item : d4
Values : 0, 1

The 12-hour format is widely used convention to represent time within 12-hour cycle, typically with **a.m.** and **p.m.** designations. The time covers 12-hour period, starting from midnight (12:00 AM) end ending at noon (11:59 AM), then continuing from noon (12:00 PM) until just before midnight (11:59 PM).

12-hour cycle is indicated by **a dot at first digit in upper left corner** .



You can either enable or disable 12-hour format:

Value	Description
0 (default value)	disabled
1	enabled

5.5. Time with Leading Zero

	Menu :	dISP
	Item :	d5
	Values :	0, 1

Time with leading zero refers to representing hours, minutes and seconds in a time format with with zero before single-digit values. This ensures uniformity in time display and enhances readability.



You can either enable or disable time with leading zero:

Value	Description
0	time with leading zero is disabled
1 (default value)	time with leading zero is enabled

5.6. Date with Leading Zero

	Menu :	dISP
	Item :	d6
	Values :	0, 1

Date with leading zero refers to representing days, month and years in a date format with with zero before single-digit values. This ensures uniformity in time display and enhances readability.

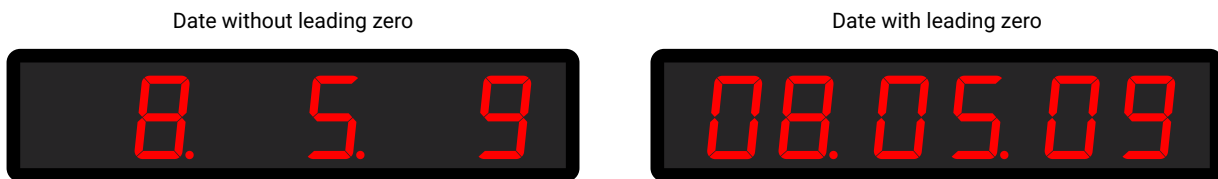

You can either enable or disable date with leading zero:

Value	Description
0 (default value)	date with leading zero is disabled
1	date with leading zero is enabled

5.7. Clock Address for IR Remote Controller

Changed in version r7.15: This item has been moved to SYST menu item c3 .

	Menu :	dISP
	Item :	d8
	Values :	1–99

The clock address for an IR remote controller is a specific identifier assigned to digital clock. This code serves as unique “address” that allows the remote controller to communicate and control particular clock. The clock control address is essential for ensuring that the remote controller signals and commands are received by the target device.

You can choose from range of values:

Value(s)	Description
1–99	Set clock address

 More information can be found in Clock Address Display .

5.8. IR Remote Controller Auto-Lock

Changed in version r7.15: This item has been moved to SYST menu item c4 .

	Menu :	dISP
	Item :	d9
	Values :	1–60, U

This feature ensures the IR reception lock of digital clock after a specific period of inactivity (since the last press of any button on the IR remote controller), preventing unintentional button presses on the IR remote controller.

You can choose from range of values:



Value(s)	Description
1–60 (minutes)	Time in minutes for auto-lock since last press of a button on IR remote controller
U	Auto-Lock is OFF

 More information can be found in Automatic lock .

5.9. Remote Control Lock

Changed in version r7.15: These setting has been moved to SYST settings menu.

The clock can be locked against unauthorized or unwanted operation using the remote controller.

-  To set clock address for IR remote controller, navigate to Clock Address (dISP menu item d8) .
-  To set the IR remote controller auto-lock after time period, navigate to IR Remote Controller Auto-Lock (dISP menu item d9)

5.9.1. Manual Lock

To lock all clock within the range of IR remote controller beam, long-press the **F2** button. Clock lock is indicated by displaying **LOC** on the clock display.

5.9.2. Automatic Lock

Automatic lock of the clock after **x** minutes (can be set in DISP menu item d9) is not indicated on the display.

5.9.3. Clock Address Display

The address display is enabled by long-press of the **F3** button and is indicated on the display as **Axx** .

xx represents the set address with initial zero.



A01 → Clock Address 1

5.9.4. Unlocking the Clock

To unlock all clocks within the range of the IR remote controller beam, long-press the **F1** button. Clock unlock is indicated by displaying **UNL** on the clock display.

To unlock only specific clock with a specific address, press the **F1** button followed by the clock address in two-digit format with leading zero. Thus, for a clock with address 5, the sequence will be as follows:

F1 0 5

Successful unlocking is indicated by displaying **UNL** on the clock display.

6 Synchronization Settings

Synchronization Settings Summary

Menu Item	Description	Value(s)
o1	Timezone of Synchronization Source	0–64, A
o2	Type of Synchronization	1–11, A
o4	Master Clock MOBALine Time Zones	1–20, 0
o5	Master Clock MOBATIME Server Time Zones	1–15, 0
10	Number of Stop Bits	1 , 2
11	Parity	n, o, E
12	Timeout for Indication of State without Synchronization	to (submenu)
13	Offset of Displayed Time	oF (submenu)

Default values are in **bold**.

6.1. Timezone of Synchronization Source



Menu :	SYNC
Item :	o1
Values :	0–64, A

Timezone synchronization is a process used to ensure that timekeeping is accurately aligned with a specific timezone. This is essential for coordinating activities, scheduling events and maintaining consistency in a globalized world.

You can choose from range of values:

Value(s)	Description
0–64	Timezone entries, see Time Zones Table
A	Automatically set timezone

6.2. Type of Synchronization



Menu :	SYNC
Item :	o2
Values :	1–12, A

For a proper synchronization process, you must specify the type of source used in your time system.

You can choose from several types of synchronization:

Value	Description
A	Autodetection (MOBALine, MOBATIME serial code, DCF, IRIG-B or NTP)
1	Autonomous operation without synchronization
2 ^[1]	Synchronization DCF
3 ^[1]	MOBATIME serial code
4 ^[1]	MOBALine
5 ^[1]	24 V VDC impulses, minute intervals
6 ^[1]	24 V VDC impulses, half minute intervals
7 ^[1]	24 V VDC impulses, second intervals
8 ^[1]	DCF-FSK- IRIG-B standard, IRIG-B 123, IRIG-B DIEM, AFNOR A, AFNOR C
9 ^[1]	Active DCF code
10 ^[2]	GPS
11 ^[3]	RS-485
12 ^{[3][4]}	Shared parameters from Master clock

^[1] only for digital clock synchronized by LGC variant

^[2] only for digital clock synchronized by GPS variant

^[3] only with RS-485 option

^[4] available only when the ShrE menu item E7 (Sharing Time) is set to value **2**

6.3. Master Clock Time Zones

This chapter provides clarification regarding the functionality of Master Clock System in simultaneous transmission of main local time alongside with preconfigured time zones.

Users have the option to select and display any of these preconfigured time zones.



If the item **o4** / **o5** is set to value **0**, received time on digital clock will set according to Time zone of Time and Date setting (dISP menu item d2).

If you set any preconfigured time zone on your digital clock, it will inherit the time definition from Master Clock (the Time zone of Time and Date setting - dISP menu item d2 - must be set to value **A**).

6.3.1. MOBALine Time Zones



This setting is available only for digital clocks with LGC variant.



Menu : SYNC
Item : o4
Values : 1–20, 0

You can choose from range of values:

Value(s)	Description
1–20	Preconfigured timezones
0	Off

6.3.2. Server MOBATIME Time Zones



This setting is available only for digital clocks with NTP, PoE, WiFi and WiFi5 variant.



Menu : SYNC
Item : o5
Values : 1–15, 0

You can choose from range of values:

Value(s)	Description
1–15	Preconfigured timezones
0	Off

6.4. Transmission Parameters for RS-485



These settings are available for digital clocks only with RS-485 option.

6.4.1. Number of Stop Bits



Menu : SYNC
Item : 10
Values : 1, 2

One or more stop bits follow the data bits, indicating the end of data frame. Stop bits provide synchronization and framing.

You can choose from values:

Value	Description
1 (default value)	Stop bits
2	Stop bits

6.4.2. Parity



Menu :	SYNC
Item :	11
Values :	n, o, E

Parity is a mechanism used to detect errors in the transmission of data between devices in RS-485 network. It involves the inclusion of an extra bit, known as parity bit, within each data frame. The parity bit is used to check whether the transmitted data has been received accurately.

You can choose from values:

Value	Description
n	No parity
o	Odd parity
E (default value)	Even parity

6.5. Timeout for Indication of State without Synchronization



Menu :	SYNC
Item :	12
Values :	to* (accessible submenu)

It serves as determining mechanism for indication of state without synchronization. This approach relies on setting a predefined time interval (timeout period) during which an expected event should occur. If the event does not occur within the specified time frame, it serves as an indication of a particular state.

Submenu **to** for setting the timeout for signalling a state without synchronization

Value	Description
ddd	Timeout value in hours set digit by digit in range 1–255 hours

6.6. Offset of Displayed Time



Menu :	SYNC
Item :	13
Values :	oF* (accessible submenu)

Offset of displayed time refers to the adjustment made to a displayed time value to reflect a time difference relative to a reference point. This offset allows users to view time information that aligns with their preferences or requirements.

Submenu **oF** for Setting the Offset of Displayed Time

Value	Description
-ddd	Timeout value in multiples of 10 ms set digit by digit in range -999 to 999 (*10 ms) Range of each digit is 0–9 – = negative offset value (e.g. -150 → offset value -1.5 s)

7 Network Settings



Network settings are available only for NTP, PoE, PoE+, WiFi or WiFi5 digital clock variant.

Network Settings Summary

Menu Item	Description	Value(s)
n1	IP Mode	0, 1, 2
n2	Communication Mode	0, 1
n3	DHCPv4 Mode	0, 1
n4	IP Address	IP (submenu)
n5	Subnet Mask	Su (submenu)
n6	Default Gateway	Gt (submenu)
n7	Multicast Address	Mc (submenu)
n8	Unicast NTP Address	Uc (submenu)
n9	NTP Polling Interval	Pi (submenu)
10	Address Autoconfiguration (SLAAC)	0, 1
11	DHCPv6 Mode	0, 1
12	WiFi Mode	1, 2, 3
13	Multicast Mode For Configuration of Digital Clock	0, 1
14	SNMP Protocol	0, 1
15	Web Server	0, 1
16	Web Server Security Mode	0, 1, 2, 3
LOCL	Link Local Address	submenu for displaying IPv6 address
SLAC	Autoconfiguration SLAAC	submenu for displaying IPv6 address
dHCP	First Address from DHCPv6	submenu for displaying IPv6 address
MANU	Manually Set IPv6 Address	submenu for displaying IPv6 address
PrEF	Prefix for Manually Set IPv6 Address	submenu for displaying IPv6 address
GAte	Gateway from Autoconfiguration SLAAC	submenu for displaying IPv6 address

Menu Item	Description	Value(s)
MAC	MAC Address	submenu for displaying MAC address

7.1. IP Mode



Menu :	NEt
Item :	n1
Values :	0 , 1, 2

IP mode refers to specific configuration and settings. It defines how devices within a network interact, how they are addressed and how data is routed.

IP mode determines whether devices within a network use IPv4 or IPv6. IPv4 is older and more widely used version, but on the other hand IPv6 is designed to address the limitation of IPv4 and accommodate the growing number of connected devices.

You can choose from several modes:

Value	Description
0 (default)	NTP, PoE: IPv4 / IPv6 WiFi: not supported
1	NTP, PoE: IPv4 WiFi: IPv4
2	NTP, PoE: IPv6 WiFi: not supported

7.2. Communication Mode



Menu :	NEt
Item :	n2
Values :	0 , 1

Communication modes are fundamental to how devices interact and share data within a network environment. These modes determine the rules, protocols and mechanisms governing data transfer.

Unicast communication involves sending data from one source to one specific destination device. It is a one-to-one communication mode.

Multicast communication involves sending data to specific group (group of devices, multicast group). Only devices that have joined the multicast group can receive the data.

You can choose from modes:

Value	Description
0 (default value)	Unicast
1	Multicast

7.3. DHCPv4 Mode



Menu : NEt
Item : n3
Values : 0, 1

DHCPv4 (**D**ynamic **H**ost **C**onfiguration **P**rotocol for IP **v4**) is a network protocol used to automate and simplify the process of assigning and managing IP addresses and related network configuration information within IPv4-based network.

You can enable or disable DHCPv4:

Value	Description
0	DHCPv4 disabled
1 (default value)	DHCPv4 enabled

7.4. IP Address



Menu : NEt
Item : n4
Values : IP* (accessible submenu)

An IP address (**I**nternet **P**rotocol address) is a unique numerical label assigned to each device connected to network that uses Internet protocol for communication. IP addresses serve as identifiers, allowing devices to send and receive data to and from one another across a network.

7.4.1. Submenu for Displaying and Editing IPv4 Address

Here you can edit IPv4 network parameters in manual setting mode or display parameters assigned to DHCPv4.

Value	Description	Range
A	1 st octet IPv4 address	0–255, set digit by digit
b	2 nd octet IPv4 address	0–255, set digit by digit
C	3 rd octet IPv4 address	0–255, set digit by digit
d	4 th octet IPv4 address	0–255, set digit by digit

7.5. Subnet Mask



Menu : NEt
Item : n5
Values : Su* (accessible submenu)

Subnet mask is a numerical value used in networking to define the boundaries and division of IP addresses within a network. It works in conjunction with IP addresses, helping to determine which part of the IP address identifies the network and which part identifies individual device within that network.

7.5.1. Submenu for Displaying and Editing IPv4 Address

Here you can edit IPv4 network parameters in manual setting mode or display parameters assigned to DHCPv4.

Value	Description	Range
A	1 st octet IPv4 address	0–255, set digit by digit
b	2 nd octet IPv4 address	0–255, set digit by digit
C	3 rd octet IPv4 address	0–255, set digit by digit
d	4 th octet IPv4 address	0–255, set digit by digit

7.6. Default Gateway



Menu : NEt
Item : n6
Values : Gt* (accessible submenu)

Default gateway serves as a key network device that facilitates communication between devices within a local network and devices in external networks.

7.6.1. Submenu for Displaying and Editing IPv4 Address

Here you can edit IPv4 network parameters in manual setting mode or display parameters assigned to DHCPv4.

Value	Description	Range
A	1 st octet IPv4 address	0–255, set digit by digit
b	2 nd octet IPv4 address	0–255, set digit by digit
C	3 rd octet IPv4 address	0–255, set digit by digit
d	4 th octet IPv4 address	0–255, set digit by digit

7.7. Multicast Address



Menu : NEt
Item : n7
Values : Mc* (accessible submenu)

Multicast address is a specialized type of IP address used in networking to deliver data packets from one sender to multiple recipients efficiently.

7.7.1. Submenu for Displaying and Editing IPv4 Address

Here you can set the multicast group IPv4 address.



The multilcast address can be set only if the Communication mode is set to multicast (NEt menu item n2 set to value 1).

Value	Description	Range
A	1 st octet IPv4 address	0–255, set digit by digit
b	2 nd octet IPv4 address	0–255, set digit by digit
C	3 rd octet IPv4 address	0–255, set digit by digit
d	4 th octet IPv4 address	0–255, set digit by digit

7.8. Unicast NTP Address



Menu :	NEt
Item :	n8
Values :	Uc* (accessible submenu)

Unicast NTP address refers to the specific IP address of an NTP server or time source to which a device sends requests for time synchronization.

7.8.1. Submenu for Displaying and Editing IPv4 Address

Here you can set unicast NTP server IPv4 address.

Value	Description	Range
A	1 st octet IPv4 address	0–255, set digit by digit
b	2 nd octet IPv4 address	0–255, set digit by digit
C	3 rd octet IPv4 address	0–255, set digit by digit
d	4 th octet IPv4 address	0–255, set digit by digit

7.9. NTP Polling Interval



Menu :	NEt
Item :	n9
Values :	Pi* (accessible submenu)

NTP poll interval refers to the frequency at which a NTP client sends time synchronization requests (NTP polls) to its configured NTP servers on peers. It determines how often the client checks and adjusts its internal clock to maintain accurate and synchronized time.

7.9.1. Submenu for Setting of NTP Polling Interval

Value	Description
ddd	Value of the polling interval set digit by digit in range 10–999 seconds The range of each digit is 0–9

7.10. Address Autoconfiguration (SLAAC)



Menu : NEt
Item : 10
Values : 0, 1

Address autoconfiguration (SLAAC) is an IPv6 address configuration method that enables devices to automatically assign and configure their IPv6 addresses based on information provided in router advertisement messages. It simplifies the process of IP address assignment in IPv6 networks and is a fundamental part of the IPv6 addressing architecture.

You can enable or disable SLAAC:

Value	Description
0	SLAAC disabled
1 (default value)	SLAAC enabled

7.11. DHCPv6 Mode



Menu : NEt
Item : 11
Values : 0, 1

DHCPv6 (D ynamic H ost C onfiguration P rotocol for IP v6) is a network protocol used to dynamically assign IPv6 addresses and configuration information to devices within an IPv6 network. DHCPv6 mode determines how IPv6 address configuration is managed.

You can either enable or disable DHCPv6 mode:

Value	Description
0	DHCPv6 disabled
1 (default value)	DHCPv6 enabled

7.12. WiFi Mode



This setting is available only for digital clocks with WiFi or WiFi5 variant



Menu : NEt
Item : 12
Values : 1, 2, 3

WiFi Modes determine the capabilities and characteristics of the wireless network, including data rates, range and compatibility with different devices.

Description of individual modes can be found in Clock Operation > Network Clock Operation > WiFi Operation Modes chapter.

You can choose from several modes:

Value	Description
1 (default value)	User-defined wireless network (defined via MOBA-NMS or Web Interface)
2	Default wireless network: MOBA-WIFI

Value	Description
3	AP mode

7.13. Multicast Mode for Configuration of Digital Clock



Menu :	NEt
Item :	13
Values :	0, 1

Multicast mode for the configuration of digital clock refers to a method of distributing time configuration information and updates to multiple digital clocks over a network using multicast communication. This mode is commonly used in scenarios where you have a large number of digital clocks that need to be synchronized with a central time server.

You can either enable or disable multicast mode:

Value	Description
0	Disable multicast mode
1 (default value)	Enable multicast mode

7.14. SNMP Protocol



Menu :	NEt
Item :	14
Values :	0, 1

SNMP (S imple N etwork M anagement P rotocol) is widely used network management protocol in networking. It is designed for monitoring and managing devices and network resources on IP networks. SNMP allows network administrators to collect information about network devices, configure their settings and receive notifications about network events.

You can either enable or disable SNMP:

Value	Description
0	Disable SNMP
1 (default value)	Enable SNMP

7.15. Web Server



Menu :	NEt
Item :	15
Values :	0, 1

Thanks to web server, you can easily set-up, view and monitor digital clock.

You can either enable or disable web server:

Value	Description
0	Disable web server
1 (default value)	Enable web server

7.16. Web Server Security Mode



This setting is available (visible) only if the Web Server is enabled – NEt menu item 15 set to value 1 .



Menu : NEt
Item : 16
Values : 0 , 1, 2, 3

This setting allows you to configure the security mode of the web server, determining how web server requests are handled.

Options are:

Value(s)	Description
0 (default value)	HTTP and HTTPS
1	HTTP only
2	HTTPS only
3	HTTP to HTTPS redirect

7.17. Link Local Address



Menu : NEt
Item : LOCL
Values : *accessible submenu for displaying IPv6 address*

Link Local Address is type of IPv6 address that is used for communication within single network segment or link. Link Local Addresses are designed to work on the local network and are typically not routed beyond that network segment.

7.17.1. Submenu for Displaying IPv6 Address



Read only

Block name of IPv6 address	Value	Description	Range
-b1-	hhhh	Hexadecimal value of the 1 st block of the IPv6 address	Cannot be edited
-b2-	hhhh	Hexadecimal value of the 2 nd block of the IPv6 address	Cannot be edited
-b3-	hhhh	Hexadecimal value of the 3 rd block of the IPv6 address	Cannot be edited
-b4-	hhhh	Hexadecimal value of the 4 th block of the IPv6 address	Cannot be edited

Block name of IPv6 address	Value	Description	Range
-b5-	hhhh	Hexadecimal value of the 5 th block of the IPv6 address	Cannot be edited
-b5-	hhhh	Hexadecimal value of the 5 th block of the IPv6 address	Cannot be edited
-b6-	hhhh	Hexadecimal value of the 6 th block of the IPv6 address	Cannot be edited
-b7-	hhhh	Hexadecimal value of the 7 th block of the IPv6 address	Cannot be edited
-b8-	hhhh	Hexadecimal value of the 8 th block of the IPv6 address	Cannot be edited

7.18. Autoconfiguration SLAAC



Menu : NEt
Item : SLAC
Values : *accessible submenu for displaying IPv6 address*

Address autoconfiguration (SLAAC) is an IPv6 address configuration method that enables devices to automatically assign and configure their IPv6 addresses based on information provided in router advertisement messages. It simplifies the process of IP address assignment in IPv6 networks and is a fundamental part of the IPv6 addressing architecture.

7.18.1. Submenu for Displaying IPv6 Address



Read only

Block name of IPv6 address	Value	Description	Range
-b1-	hhhh	Hexadecimal value of the 1 st block of the IPv6 address	Cannot be edited
-b2-	hhhh	Hexadecimal value of the 2 nd block of the IPv6 address	Cannot be edited
-b3-	hhhh	Hexadecimal value of the 3 rd block of the IPv6 address	Cannot be edited
-b4-	hhhh	Hexadecimal value of the 4 th block of the IPv6 address	Cannot be edited
-b5-	hhhh	Hexadecimal value of the 5 th block of the IPv6 address	Cannot be edited
-b5-	hhhh	Hexadecimal value of the 5 th block of the IPv6 address	Cannot be edited
-b6-	hhhh	Hexadecimal value of the 6 th block of the IPv6 address	Cannot be edited
-b7-	hhhh	Hexadecimal value of the 7 th block of the IPv6 address	Cannot be edited
-b8-	hhhh	Hexadecimal value of the 8 th block of the IPv6 address	Cannot be edited

7.19. First address from DHCPv6



Menu : NET
Item : dHCP
Values : *accessible submenu for displaying IPv6 address*

In DHCPv6, the first address that a client typically requests is an IPv6 address for its network interface.

7.19.1. Submenu for Displaying IPv6 Address



Read only

Block name of IPv6 address	Value	Description	Range
-b1-	hhhh	Hexadecimal value of the 1 st block of the IPv6 address	Cannot be edited
-b2-	hhhh	Hexadecimal value of the 2 nd block of the IPv6 address	Cannot be edited
-b3-	hhhh	Hexadecimal value of the 3 rd block of the IPv6 address	Cannot be edited
-b4-	hhhh	Hexadecimal value of the 4 th block of the IPv6 address	Cannot be edited
-b5-	hhhh	Hexadecimal value of the 5 th block of the IPv6 address	Cannot be edited
-b5-	hhhh	Hexadecimal value of the 5 th block of the IPv6 address	Cannot be edited
-b6-	hhhh	Hexadecimal value of the 6 th block of the IPv6 address	Cannot be edited
-b7-	hhhh	Hexadecimal value of the 7 th block of the IPv6 address	Cannot be edited
-b8-	hhhh	Hexadecimal value of the 8 th block of the IPv6 address	Cannot be edited

7.20. Manually set IPv6 address



Menu : NET
Item : MANU
Values : *accessible submenu for displaying IPv6 address*

Here you can view manually set IPv6 address which has been set in other way, e.g. web interface.

7.20.1. Submenu for Displaying IPv6 Address



Read only

Block name of IPv6 address	Value	Description	Range
-b1-	hhhh	Hexadecimal value of the 1 st block of the IPv6 address	Cannot be edited
-b2-	hhhh	Hexadecimal value of the 2 nd block of the IPv6 address	Cannot be edited
-b3-	hhhh	Hexadecimal value of the 3 rd block of the IPv6 address	Cannot be edited
-b4-	hhhh	Hexadecimal value of the 4 th block of the IPv6 address	Cannot be edited
-b5-	hhhh	Hexadecimal value of the 5 th block of the IPv6 address	Cannot be edited
-b5-	hhhh	Hexadecimal value of the 5 th block of the IPv6 address	Cannot be edited
-b6-	hhhh	Hexadecimal value of the 6 th block of the IPv6 address	Cannot be edited
-b7-	hhhh	Hexadecimal value of the 7 th block of the IPv6 address	Cannot be edited
-b8-	hhhh	Hexadecimal value of the 8 th block of the IPv6 address	Cannot be edited

7.21. Prefix for manually set IPv6 address



Menu : NET
 Item : PrEF
 Values : *accessible submenu for displaying IPv6 address*

Prefix is a portion of the IPv6 address that represents the network segment to which the device or network interface belongs.

7.21.1. Submenu for Displaying IPv6 Address



Read only

Block name of IPv6 address	Value	Description	Range
-b1-	hhhh	Hexadecimal value of the 1 st block of the IPv6 address	Cannot be edited
-b2-	hhhh	Hexadecimal value of the 2 nd block of the IPv6 address	Cannot be edited
-b3-	hhhh	Hexadecimal value of the 3 rd block of the IPv6 address	Cannot be edited
-b4-	hhhh	Hexadecimal value of the 4 th block of the IPv6 address	Cannot be edited
-b5-	hhhh	Hexadecimal value of the 5 th block of the IPv6 address	Cannot be edited

Block name of IPv6 address	Value	Description	Range
-b5-	hhhh	Hexadecimal value of the 5 th block of the IPv6 address	Cannot be edited
-b6-	hhhh	Hexadecimal value of the 6 th block of the IPv6 address	Cannot be edited
-b7-	hhhh	Hexadecimal value of the 7 th block of the IPv6 address	Cannot be edited
-b8-	hhhh	Hexadecimal value of the 8 th block of the IPv6 address	Cannot be edited

7.22. Gateway from autoconfiguration SLAAC



Menu : NET
 Item : GAtE
 Values : *accessible submenu for displaying IPv6 address*

Gateway in context of SLAAC is a critical network device that provides essential routing information to IPv6 devices. It is responsible for announcing the network's prefix and prefix length, allowing devices to configure their IPv6 addresses automatically.

7.22.1. Submenu for Displaying IPv6 Address



Read only

Block name of IPv6 address	Value	Description	Range
-b1-	hhhh	Hexadecimal value of the 1 st block of the IPv6 address	Cannot be edited
-b2-	hhhh	Hexadecimal value of the 2 nd block of the IPv6 address	Cannot be edited
-b3-	hhhh	Hexadecimal value of the 3 rd block of the IPv6 address	Cannot be edited
-b4-	hhhh	Hexadecimal value of the 4 th block of the IPv6 address	Cannot be edited
-b5-	hhhh	Hexadecimal value of the 5 th block of the IPv6 address	Cannot be edited
-b5-	hhhh	Hexadecimal value of the 5 th block of the IPv6 address	Cannot be edited
-b6-	hhhh	Hexadecimal value of the 6 th block of the IPv6 address	Cannot be edited
-b7-	hhhh	Hexadecimal value of the 7 th block of the IPv6 address	Cannot be edited
-b8-	hhhh	Hexadecimal value of the 8 th block of the IPv6 address	Cannot be edited

7.23. MAC address



Menu :	NEt
Item :	MAC
Values :	<i>accessible submenu for displaying MAC address</i>

MAC address (**M**edia **A**ccess **C**ontrol) is unique identifier assigned to a network interface card or controller in a device. It serves as a hardware address that distinguishes one network device from another on local network.

7.23.1. Submenu for Displaying MAC Address



Only last two octet can be defined under special conditions; conditions not yet set.

Item	Description	Values
L1	1 st octet of MAC address	0x00
L2	2 nd octet of MAC address	0x16
L3	3 rd octet of MAC address	0x91
L4	4 th octet of MAC address	0xFD, 0xFD
L5	5 th octet of MAC address	0x00–0xFF
L6	6 th octet of MAC address	0x00–0xFF

8 Sensor Settings



Depending on sensor type.

Sensor Settings Summary

Menu Item	Description	Value(s)
t1	Sensor Type	P3, P2, P1, -, 0 , 1, 2, 3, 4, 5, 6, 7, 8, 9, 10, 11
t2	Displayed Temperature Correction	cT (submenu)
t3	Temperature Units Display	0 , 1
t4	Temperature Units	°C, °F
t6	Displayed Humidity Correction	ch (submenu)
t7	Humidity Units Display	0 , 1
t8	Humidity Units	rh , Hr
10	Displayed Pressure Correction	cP (submenu)
11	Pressure Units Display	0 , 1
12	Pressure Unit	hp
14	Temperature Preset Value	PT (submenu)
15	Humidity Preset Value	PH (submenu)
16	Pressure Preset Value	PP (submenu)
17	Input Number for Sensor One-Wire	1 , 2
22	LAN Sensor Communication Protocol Type	1, 2
23	LAN Sensor IP Address	IP (submenu)

Default values are in **bold**.

8.1. Sensor Type



Menu : SENx
 Item : t1
 Values : P3, P2, P1, -, **0**, 1, 2, 3, 4, 5, 6, 7, 13, 14, 15

There are numerous sensor types, each optimized for particular application.

You can choose from desired sensor type:

Value	Sensor Type
P3	TPHB preset value

Value	Sensor Type
P2	TPH preset value
P1	TP preset value
-	No sensor
0 (default value)	TP3/30
1	TPH 1m
2 [1]	TP LAN
3 [1]	TP LAN PoE
4 [1]	TPHP LAN
5 [1]	TPHP LAN PoE
6 [1]	TPH PoE
7 [1]	TPHB LAN
13 [1]	TP Shared
14 [1]	TPH Shared
15 [1]	TPHB Shared

[1] only with NTP, PoE, WiFi or WiFi5 variant

[2] only with RS-485 option

[3] only with NTP, PoE, WiFi or WiFi5 variant and/or RS-485 option

8.2. Input number for sensor One-Wire



Menu : SENx
Item : 17
Values : 1, 2

You can choose from input TEMP1 or TEMP2:

Value(s)	Description
1 (default value)	Input TEMP1
2	Input TEMP2

8.3. Temperature sensor

8.3.1. Displayed temperature correction

	Menu :	SENx
	Item :	t2
	Values :	cT* (with accessible submenu)

This setting ensures accuracy and reliability of displayed temperature. Temperature sensors may have inherent inaccuracies or drift over time.

Submenu cT

Submenu for setting the temperature correction

Value(s)	Description	Range
-d.d	Setting of the displayed temperature correction on display	- = negative value d.d = value of correction set digit by digit, the range of each digit is 0-9 Range: -9.9 to 9.9 °C

8.3.2. Temperature units display

	Menu :	SENx
	Item :	t3
	Values :	0, 1

You can either enable or disable display of temperature units:

Value(s)	Description
0	Disabled (no units displayed)
1 (default value)	Enabled (units displayed)

8.3.3. Temperature units

	Menu :	SENx
	Item :	t4
	Values :	°C, °F

Temperature sensor units are degrees Celsius or Fahrenheit.

The Celsius scale is widely used for measuring temperature in most of the world. It is based on the freezing point (0 °C) and boiling point (100 °C) of water under standard atmospheric pressure at sea level. It is the default unit used for temperature sensors.

The Fahrenheit scale is mainly used in the United States. It is based on the freezing point (32 °F) and boiling point (212 °F) of water under standard atmospheric pressure at sea level.

You can choose between two types of temperature units:

Value(s)	Description
°C (default units)	Celsius degrees

Value(s)	Description
°F	Fahrenheit degrees

8.3.4. Preset value



Menu :	SENx
Item :	14
Values :	PT* (with accessible submenu)

The sensor preset value ensures that your defined value is displayed, regardless of the sensor reading or even if the sensor is not connected at all.

Here you can set the preset temperature value.

Submenu PT

Submenu for setting the preset temperature value:

Value(s)	Description	Range
ddd	Setting of the preset temperature value	dd.d = preset value set digit by digit, the range of each digit is 0–9 Range: -99 to 999
- .d	Setting of the decimal part	d = value Range: 0 to 9

8.4. Humidity sensor

8.4.1. Displayed humidity correction



Menu :	SENx
Item :	t6
Values :	cH* (with accessible submenu)

This setting ensures accuracy and reliability of displayed humidity. Humidity sensors may have inherent inaccuracies or drift over time.

8.4.1.1. Submenu cH

Submenu for setting the humidity correction

Value(s)	Description	Range
-d.d	Setting of the displayed humidity correction on display	- = negative value d.d = value of correction set digit by digit, the range of each digit is 0–9 Range: -9.9 to 9.9

8.4.2. Humidity units display

	Menu :	SENx
	Item :	t7
	Values :	0, 1

You can either enable or disable display of humidity units:

Value(s)	Description
0	Disabled (no units displayed)
1 (default value)	Enabled (units displayed)

8.4.3. Humidity units

	Menu :	SENx
	Item :	t8
	Values :	rH , Hr

Humidity is represented in relative humidity units (rh or Hr). Relative humidity is the most common unit for expressing humidity levels. It represents the amount of water vapor in the air as a percentage of the maximum amount of water vapor the air can hold at a given temperature and pressure.

Relative humidity values range from 0% (completely dry air) to 100% (saturated air, where the air cannot hold any more moisture).

You can choose between two types of relative humidity units:

Value(s)	Description
rH (default unit)	Relative humidity
Hr	

8.4.4. Preset value

	Menu :	SENx
	Item :	15
	Values :	PH* (with accessible submenu)

The sensor preset value ensures that your defined value is displayed, regardless of the sensor reading or even if the sensor is not connected at all.

Here you can set the preset humidity value.

8.4.4.1. Submenu PH

Submenu for setting the preset humidity value

Value(s)	Description	Range
dd	Setting of the preset humidity value	dd.d = preset value set digit by digit, the range of each digit is 0–9 Range: -99 to 99
-.d	Setting of the decimal part	d = value Range: 0 to 9

8.5. Pressure sensor

8.5.1. Displayed pressure correction



Menu :	SENx
Item :	10
Values :	cP* (with accessible submenu)

This setting ensures accuracy and reliability of displayed pressure. Pressure sensors may have inherent inaccuracies or drift over time.

8.5.1.1. Submenu cP

Submenu for setting the pressure correction

Value(s)	Description	Range
-ddd	Setting of the displayed pressure correction on display	- = negative value ddd = value of correction set digit by digit, the range of each digit is 0–9 Range: -999 to 999

8.5.2. Pressure units display



Menu :	SENx
Item :	11
Values :	0, 1

You can either enable or disable display of pressure units:

Value(s)	Description
0	Disabled (no units displayed)
1 (default value)	Enabled (units displayed)

8.5.3. Pressure units



Menu : SENx
 Item : 12
 Values : hp

Pressure is a measure of the force applied to a given area. The default pressure sensor unit is Hectopascal (hPa, on sensor it is displayed as **hp**). It is equivalent to 100 Pa.

It is useful for expressing air pressure at various altitudes and for tracking changes in atmospheric pressure that can indicate weather patterns.

There is only one pressure unit available:

Value(s)	Description
hp	Hectopascal

8.5.4. Preset value



Menu : SENx
 Item : 16
 Values : PP* (with accessible submenu)

The sensor preset value ensures that your defined value is displayed, regardless of the sensor reading or even if the sensor is not connected at all.

Here you can set the preset pressure value.

8.5.4.1. Submenu PP

Submenu for setting the preset pressure value

Value(s)	Description	Range
dddd	Setting of the preset pressure value	dd.d = preset value set digit by digit, the range of each digit is 0–9 Range: 0 to 9999
-.d	Setting of the decimal part	d = value Range: 0 to 9

8.6. LAN sensor



Available only with NTP, PoE, WiFi or WiFi5 variant.

8.6.1. Communication protocol type



Menu :	SENx
Item :	22
Values :	1, 2

Type of communication protocol for LAN sensors depends on the specific requirements of the sensors and the network infrastructure in use.

You can choose between Modbus or Spinel communication protocol:

Value(s)	Description
1	Modbus
2	Spinel

8.6.2. IP address



Menu :	SENx
Item :	23
Values :	IP* (with accessible submenu)

An IP address (I nternet P rotocol address) is a unique numerical label assigned to each device connected to network that uses Internet protocol for communication.

IP addresses serve as identifiers, allowing devices to send and receive data to and from one another across a network.

8.6.2.1. Submenu IP

Submenu for setting IP address

Here you can set the IP address of sensor.

Value(s)	Description	Range
A	1 st octet IPv4 address	0–255, set digit by digit
b	2 nd octet IPv4 address	0–255, set digit by digit
C	3 rd octet IPv4 address	0–255, set digit by digit
d	4 th octet IPv4 address	0–255, set digit by digit

9 Stopwatch settings

Stopwatch Settings Summary

Menu Item	Description	Value(s)
PreS	Stopwatch Start Time	submenu
h1	Counting Direction	1 , 2, 3, 4
h2	Control Mode	1 , 2, 3, 4, 5, 6
h3	Counting Unit	1 , 2, 3, 4
h4	Contact Closing	0 , 1–30, C
h6	External Keyboard Connection	0 , 1
h7	Timeout to Switch to Default Display for BRB	0 , 1–99

Default values are in **bold**.

9.1. Stopwatch start time



Menu :	StoP
Item :	PreS
Values :	<i>submenu</i>

This setting is crucial for setting the stopwatch start time for downwards counting.

Submenu for setting the stopwatch start time

Displayed Item	Value(s)	Description	Range
HH : MM	HH	Hour setting	Range 0–99
	MM	Minute setting	Range 0–59
SS . HsHs	SS	Seconds setting	Range 0–59
	HsHs	1/100 second setting	Range 0–99

9.2. Counting direction



Menu :	StoP
Item :	h1
Values :	1 , 2, 3, 4

Stopwatch counting direction refers to whether it counts upwards or downwards (with stop at zero or with automatic restart from specified time value or keeping the count into negative values).

You can choose whether you want counting upwards or downwards:

Value	Description
1 (default value)	Upwards
2	Downwards from a set time value, with stop at zero
3	Downwards from a set time value, with automatic restart from specified time value
4	Downwards from a set time value, until zero and keeping the count into negative values

9.3. Control mode



Menu : StoP
Item : h2
Values : 1 , 2, 3, 4, 5, 6

You can choose from several control modes:

Value	Description
1 (default value)	Control Mode 1
2	Control Mode 2
3	Control Mode 3
4	Control Mode 4
5	Control Mode 5
6	Control Mode 6

9.3.1. Control mode 1

Remote controller button	Push-button	Function
S/S	PB3	Altering START - STOP - UNFREEZE of display (if freezed display)
HOLD	PB1	FREEZE of displayed data with the counter proceeding in counting
RESET	PB1L	Setting the counter to zero in STOP operating mode for counting up, or return to a preset value in all other counting directions

Stopwatch display

display of zeroes or preset value

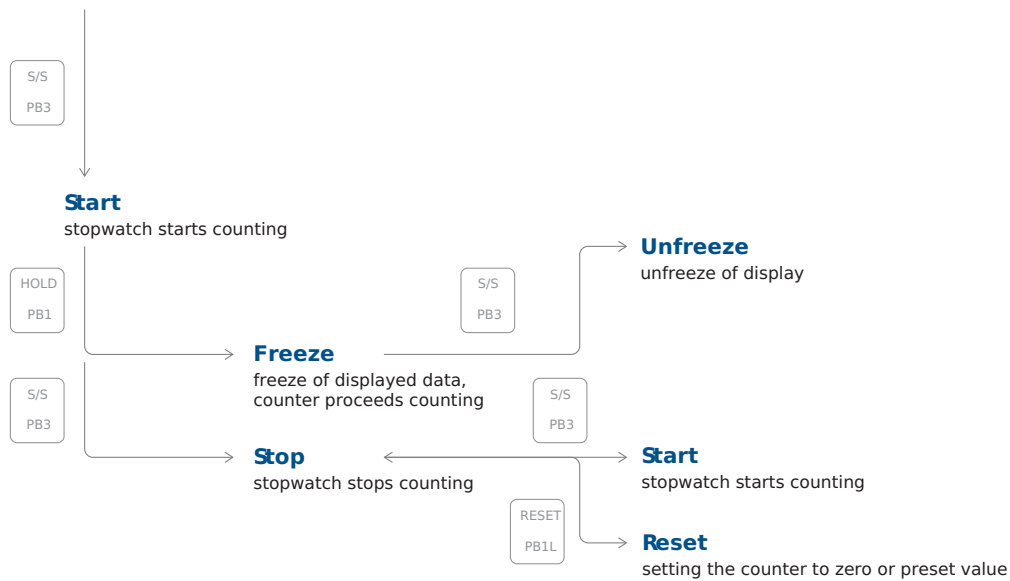

9.3.2. Control mode 2

Remote controller button	Push-button	Function
S/S	PB3	Altering START - STOP - UNFREEZE of display (if freezed display)
HOLD	PB1	First press of push-button causes the display to freeze on the respective time achieved and lets counter running; further activation of push-button shows the intermediate time elapsed from the first press
RESET	PB1L	Reset of the counter in the STOP mode while in counting up, return to preset value in other counting modes

Stopwatch display

display of zeroes or preset value

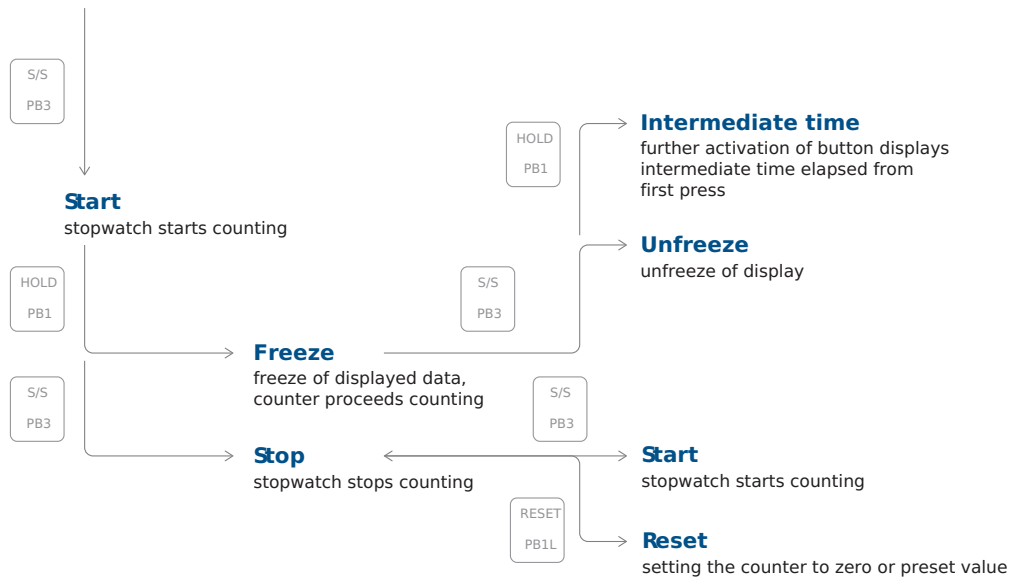

9.3.3. Control mode 3

Remote controller button	Push-button	Function
S/S	PB3	Count up from zero or from preset value in countdown mode, next press of push-button causes the display to freeze and to resume the count from zero in counting up or from preset value in countdown mode
HOLD	PB1	Unfreeze of display, leaving the counter continue in counting
RESET	PB1L	Counter reset to zero or return to preset value followed with counter stop

Stopwatch display

display of zeroes or preset value

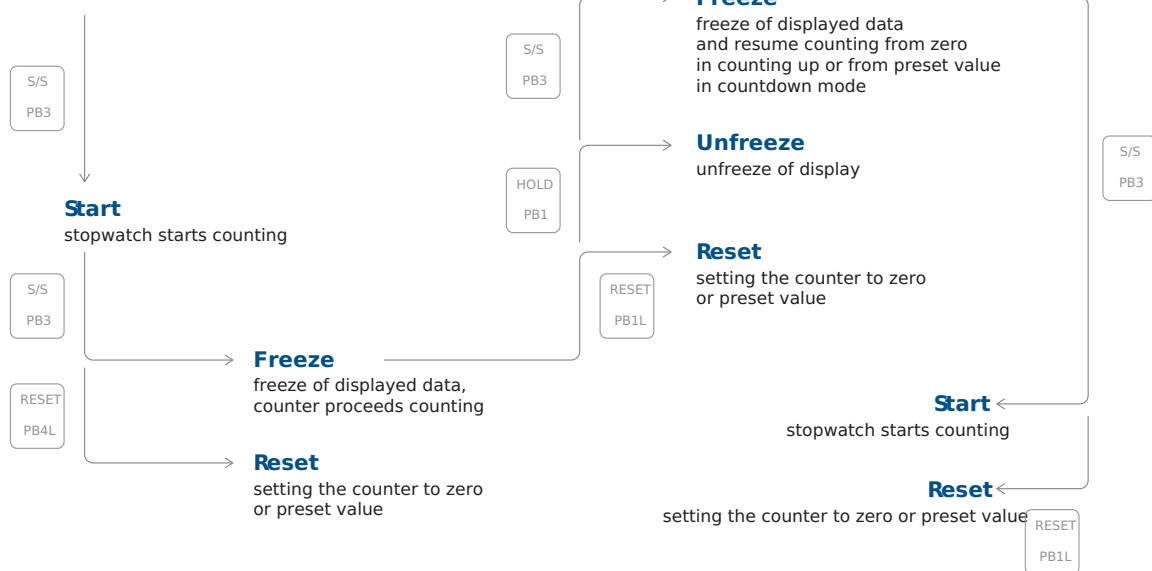

9.3.4. Control mode 4

Remote controller button	Push-button	Function
S/S	PB3	Triggering the counter
HOLD	PB1	Stopping the counter
RESET	PB1L	Resetting the counter or return to preset value with counter stop

Stopwatch display

display of zeroes or preset value

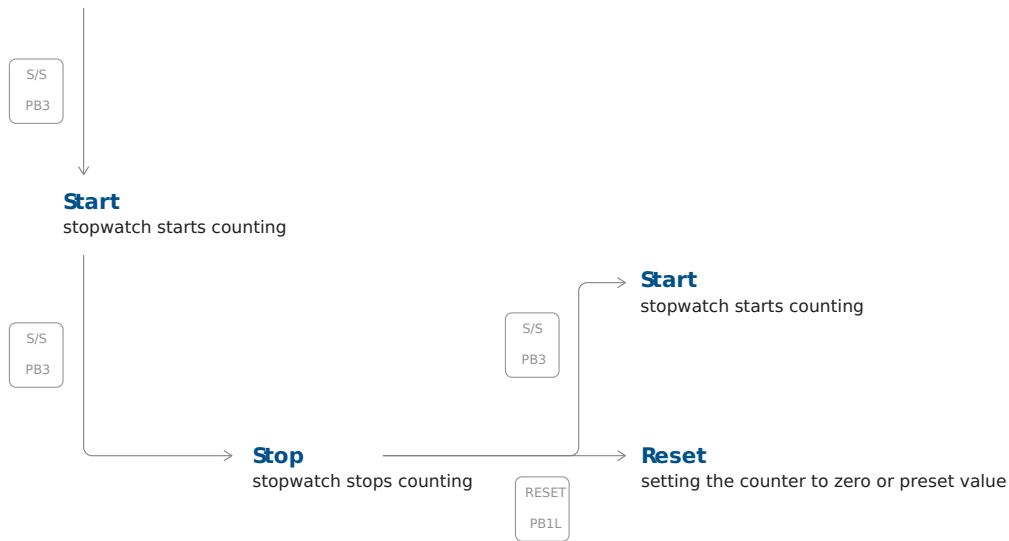

9.3.5. Control mode 5

Remote controller button	Push-button	Function
S/S	BRB10	Alternately: <ol style="list-style-type: none"> 1. Start 2. Stop 3. Reset

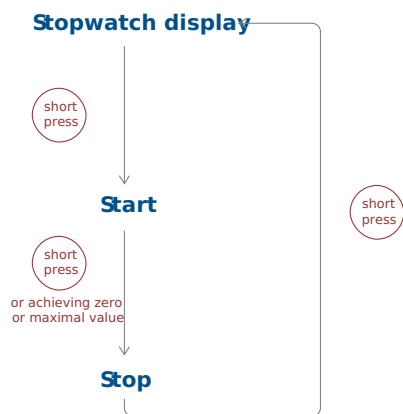

9.3.6. Control mode 6

Remote controller button	Push-button	Function
S/S	BRB10	Alternately: <ol style="list-style-type: none"> 1. Stopwatch display + Start 2. Stop 3. Default display + Reset

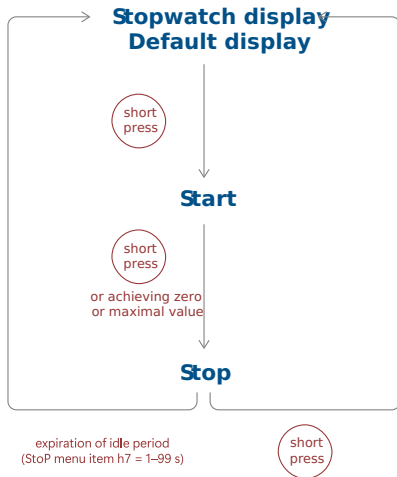

Default display can be set in dISP menu item d3 (Time Constants) :

1. **Display OFF**



If the dISP menu item d3 is set to value **4** (continuous display of stopwatch), the display will switch OFF after the expiration of idle period or short press of button.

2. **Display Time, Date or Temperature**

If the dISP menu item d3 set to value **0, 1, 2, 3, 5, 6** or **U**, the display will switch to either Time, Date or Temperature display after a expiration of idle period or short press of button.

9.4. Counting unit



Menu : StoP
Item : h3
Values : 1, 2, 3, 4

The stopwatch counting unit determines how time is divided and displayed as the stopwatch runs. The counting unit vary depending on the stopwatch's design and purpose.

You can choose from various counting units:

Value	Description
1 (default value)	Counting in increments of 1/100 seconds (with 4-digit display the counting goes on until 59.99 seconds and then continues with displaying minutes : seconds), up to 59 minutes and 59.99 seconds at maximum
2	Counting in increments of 1 second (with 4-digit display the counting goes on until 59 minutes and 59 seconds and then with displaying of hours : minutes), until 23 hours, 59 minutes and 59 seconds at maximum
3	Counting in 1 minute steps, until 23 hours and 59 minutes
4	Counting in periods after one day subtraction or addition always takes place around midnight, capacity of counting up to 9999 days, when counting is stopped, the dots is displayed after the last digit

9.5. Contact closing



This setting is available only with REL option.



Menu : StoP
Item : h4
Values : 0, 1–30, C

Stopwatch contact closing is a fundamental operation used in various applications where precise timing is required, such as in sports, scientific experiments, cooking, and many other field.

You can setup the stopwatch contact closing or disable it:

Value	Description
0 (default value)	Function disabled
1–30	Time period of contact for stopwatches, passing through zero while operating in countdown mode, starting from preset value
C	Contact is closed during active counting

9.6. External keyboard connection



Menu : StoP
Item : h6
Values : 0, 1

You either enable or disable external keyboard connection:

Value	Description
0 (default value)	Function disabled
1	Connected



If the external keyboard is connected, the TP3/30m and TPHP temperature sensors **cannot be connected**.

9.7. Timeout to switch to default display for BRB



Menu : StoP
Item : h7
Values : 0, 1–99

Here you can set the timeout to switch to default display after pressing the BRB10 button.

You can either disable or set the time in seconds:

Value	Description
0 (default value)	Function disabled

Value	Description
1-99	Time in seconds to go to the default display after stopping the stopwatch or reaching the target time

9.8. BRB10 connection

10 Time & date settings



Use these settings solely for autonomous mode or when utilizing an impulse line.

Time & Date Settings Summary

Menu Item	Description	Value(s)
HH:MM	Time	Time Setting Submenu
DD.MM.	Date	date & year setting submenu
20YY	Year	date & year setting submenu

10.1. Time



Menu : tIME
 Item : HH:MM
 Values : submenu

Here you can set-up displayed time.

Submenu for setting time

Value	Description	Range
HH	Setting of hour	Range 0–23
MM	Setting of minutes	Range 0–59

10.2. Date and year



Menu : tIME
 Item : DD. MM., 20YY
 Values : submenu

Here you can set-up displayed date and year.

Submenu for setting date (and year)

Value	Description	Range
DD	Setting of day	Range 1–31
MM	Setting of month	Range 1–12
YY	Setting of year	Range 0–99



If the set date is out of valid range while saving the set year, it will be automatically corrected. The menu will not be saved, it will return back to the beginning of setting the day and it is necessary to go through the entire setting menu again to confirm or modify the suggested date changes.

11 System Settings

System Settings Summary

Menu Item	Description	Value(s)
c0	Diagnostic Tools	1 , 2, 3, 4, 5, 6, 7, 8
c1	Factory Reset	0 , 1
c2	Firmware Update via USB Process Settings	0 , 1 (submenu)
c3	Clock Address for IR Remote Controller New since version r7.15	1–99
c4	IR Remote Controller Auto-Lock New since version r7.15	1–60, U
c5	Display Brightness Derating	0, -1, -2, -3, -4, -5
c6	Light Sensor Correction	5, 4, 3, 2, 1, 0, -1, -2, -3, -4, -5
c7	Individual Digit Brightness Setting New since version r8.02	submenu di
c8	Individual Dot Brightness Setting New since version r8.02	submenu do

Default values are in **bold** .



The menu items indicated by red line may not be available to all users. Its availability can vary depending on device configuration.

The menu items may be available for all users in future versions.

11.1. Diagnostic tools



Menu : SYSt
Item : c0
Values : 1 , 2, 3, 4, 5, 6, 7, 8

Diagnostic tools are set of specialized features and tools that allow you to monitor clock’s functions.

You can choose from values:

Value(s)	Description
1 * (default value)	Display test
2 *	Display of active alarms
3 *	Display of internal temperature

Value(s)	Description
4 *	Display of test results
5 *	Display of calibration deviation
6 *	Passive DCF diagnostic menu
7 *	Display of line quality diagnostics
8 *	GPS diagnostic menu

All values have accessible submenu.

11.1.1. Display test submenu

After entering this item, all segments of the display will light up.

4-digit display



6-digit display



11.1.2. Active alarms submenu

Value(s)	Description
AL : --	If any alarm is not active
AL : xx	xx represents active alarm bit:
0	Synchronization lost in last one hour
6	Device restart
7	NMS communication error
8	Time zone error (season server)
9	NMS authentication error
33 *	Empty calibration value (not calibrated)
34 *	Synchronization timeout
35 *	Not tested (test not passed)
36 *	SSL certificates not present
39 *	Hardware error – some module or peripheral is not present

To browse between active bits, use **>>** or **PB2**.

Alarm bits with * are indicated by state LED.

11.1.3. Internal temperature submenu

Value(s)	Description
dd °C	dd represents internal temperature in °C Example: 25 °C

11.1.4. Test results submenu

Value(s)	Description
PASS	Tested in production with pass result
FAIL	Tested in production with failed result
Not	Not tested in production

11.1.5. Calibration deviation submenu

Value(s)	Description
-- --	Calibration deviation greater than 1000 ppm
0xxx	Calibration deviation greater than 100 ppm
xx.xx	Calibration deviation less than 100 ppm

Negative deviation is indicated by a lit dot at the first digit.

Currently running calibration is indicated by a flashing decimal point.

11.1.6. Passive DCF diagnostic menu



xx:yz – display during the minute, i.e. when receiving bits

Value(s)	Description
xx	Number of bits received in the current minute, ideally the counter corresponds to the current seconds value (range 0–58)
y	Value of the last received bit (value 0 or 1)
z	The number of consecutive telegrams received with time that were decoded without error Range 0–9, value greater than 9 is then displayed with a decimal point, i.e. 9.

At one full minute (or if there is a pause between incoming bits of approx. 2 seconds), i.e. it is assumed that the whole telegram is received, a screen is displayed which shows the result of the telegram processing:

Value(s)	Description
--:--z	Indicates successful processing of the DCF telegram, when z indicates the current value of the counter of consecutive received telegrams
Er:dd	Value dd corresponds to the possible states listed below:
0x01	incorrect number of received bits
0x02	missing start bit for the beginning of the telegram
0x04	missing start bit for time reception
0x08	parity error when decoding the minutes value
0x10	parity error when decoding the hours value
0x20	parity error in date decoding
0x40	invalid decoded time range
0x80	invalid decoded date range

11.1.7. Line quality diagnostics submenu

The individual parameters are displayed as submenu items. You can browse between individual parameters by pressing the  or .

Value(s)	Description
Sc	detected synchronization signal source type submenu
Sc:--	the synchronization source is not yet identified when auto is selected
Sc:xx	value xx indicates the type of the identified link, the displayed value corresponds to the description of the SYNC menu item o2 (Type of synchronization)
u	detected synchronization signal quality submenu
u---	the synchronisation signal is not yet correctly detected
uxxx	value xxx corresponds to the percentage of the synchronization signal processing quality
Er	number of synchronization signal processing errors submenu
Er:xx	value xx in range 0–99
Er:99.	counter value is greater than 99
t	countdown of the time limit in seconds for restarting the synchronization signal detection process submenu
txxx	value xxx in range 0–999
t999.	counter value is greater than 999

Value(s)	Description
	With successful signal processing, the countdown never reaches zero
St	synchronization signal processing status submenu
St :xx	value xx corresponds to the possible states:
0	unknown
1	line detected
2	line frame detected
3	line frame checked
4	line time detected
5	time zone detected

11.1.8. GPS diagnostic submenu

Value(s)	Description
St	GPS status
EE	GPS module error. Not present or not communicating.
--	GPS not detected
2d	2D Fix – GPS detected in 2D mode
3d	3D Fix – GPS detected in 3D mode
Su	Number of satellites used to calculate position
SA	Number of available satellites
PP	Position Determination Accuracy (PDOP)
HI	Highest PDOP < 1.0
1-2	High
2-5	Good
5-10	Sufficient
10-20	Low
L0	Very Low PDOP > 20

11.2. Factory Reset



Menu : SYSt
 Item : c1
 Values : 0, 1

You can choose from range of values:

Value(s)	Description
0 (default value)	No function
1 *	Invoke factory reset, proceeds to enter Submenu for Factory Reset

11.2.1. Submenu for Factory Reset

Value(s)	Description
FAC	FAC inscription flashes, confirming OK or PB2 will invoke default settings



In cases where a misconfiguration has caused the clock to enter a reset loop (making this menu item or menu generally not accessible), use Factory reset using push-buttons and reset button .

11.3. Firmware update via USB process settings

✓ Added in version r7.07.



Available only for LGC or GPS variant.



Menu : SYSt
 Item : c2
 Values : 0, 1* (with accessible submenu)

Firmware update is a process of upgrading software that is embedded in a hardware device. These updated can bring various benefits, such as bug fixes or new features. This settings allows to update the firmware of the clock via USB drive with update file on it.

You can choose from these values:

Value(s)	Description
0 (default value)	No function
1 *	Invoke firmware update process Enter the submenu for firmware update

11.3.1. Submenu for firmware update

Value(s)	Description
FU:xx	FU:xx inscription flashes, where xx represents USB signalization state

Value(s)	Description
FU:1-99	the process of copying file
FU: 0	USB drive initialization is OK
FU: -1	USB drive not loaded
FU: -2	update file not found
FU: -3	invalid file for the device
FU: -4	unknown error

For state 0, confirming **OK** or **PB2L** starts the update process; if the file on the drive is OK, the copy process starts and its progress is displayed as a positive number in range 1-99.

11.4. Clock Address for IR Remote Controller



If your firmware version is **r7.14** or lower, you may find this setting in DISP menu settings item d8.



Menu : SYSt
Item : c3
Values : 1-99

The clock address for an IR remote controller is a specific identifier assigned to digital clock. This code serves as unique “address” that allows the remote controller to communicate and control particular clock. The clock control address is essential for ensuring that the remote controller signals and commands are received by the target device.

You can choose from range of values:

Value(s)	Description
1-99	Set clock address



More information can be found in Clock Address Display.

11.5. IR Remote Controller Auto-Lock



If your firmware version is **r7.14** or lower, you may find this setting in DISP menu settings item d9.



Menu : SYSt
Item : c4
Values : 1-60, U

This feature ensures the IR reception lock of digital clock after a specific period of inactivity (since the last press of any button on the IR remote controller), preventing unintentional button presses on the IR remote controller.

You can choose from range of values:

Value(s)	Description
1-60 (minutes)	Time in minutes for auto-lock since last press of a button on IR remote controller

Value(s)	Description
U	Auto-Lock is OFF



More information can be found in Automatic lock .

11.6. Remote Control Lock



If your firmware version is **r7.14** or lower, you may find these setting in DISP menu settings.

The clock can be locked against unauthorized or unwanted operation using the remote controller.



To set clock address for IR remote controller, navigate to Clock Address (SYST menu item c3) .

To set the IR remote controller auto-lock after time period, navigate to IR Remote Controller Auto-Lock (SYST menu item c4)

11.6.1. Manual Lock

To lock all clock within the range of IR remote controller beam, long-press the **F2** button. Clock lock is indicated by displaying **LOC** on the clock display.

11.6.2. Automatic Lock

Automatic lock of the clock after **x** minutes (can be set in SYST menu item c4) is not indicated on the display.

11.6.3. Clock Address Display

The address display is enabled by long-press of the **F3** button and is indicated on the display as **Axx** .

xx represents the set address with initial zero.



A01 → Clock Address 1

11.6.4. Unlocking the Clock

To unlock all clocks within the range of the IR remote controller beam, long-press the **F1** button. Clock unlock is indicated by displaying **UNL** on the clock display.

To unlock only specific clock with a specific address, press the **F1** button followed by the clock address in two-digit format with leading zero. Thus, for a clock with address 5, the sequence will be as follows:

F1 0 5

Successful unlocking is indicated by displaying **UNL** on the clock display.

11.7. Display Brightness Derating

✔ Added in version r8.0.

	Menu :	SYSt
	Item :	c5
	Values :	0, -1, -2, -3, -4, -5

Display brightness derating is a feature that adjusts the brightness of display based on specific conditions or user preferences.

You can choose from range of values:

Value	Description
0	Display Brightness Derating 0%
-1	Display Brightness Derating -10%
-2	Display Brightness Derating -20%
-3	Display Brightness Derating -30%
-4	Display Brightness Derating -40%
-5	Display Brightness Derating -50%

11.8. Light Sensor Correction

✔ Added in version r8.0.

	Menu :	SYSt
	Item :	c6
	Values :	5, 4, 3, 2, 1, 0, -1, -2, -3, -4, -5

Light sensor correction setting is a feature designed to optimize the accuracy and performance of light sensor used to automatically adjust a display brightness.

You can choose from range of values:

Value	Description
5	Light Sensor Correction 50%
4	Light Sensor Correction 40%
3	Light Sensor Correction 30%
2	Light Sensor Correction 20%
1	Light Sensor Correction 10%
0	Light Sensor Correction 0%
-1	Light Sensor Correction -10%
-2	Light Sensor Correction -20%
-3	Light Sensor Correction -30%
-4	Light Sensor Correction -40%

Value	Description
-5	Light Sensor Correction -50%

11.9. Individual Digit Brightness Setting

✓ Added in version r8.02.



This menu item may not be available to all users. Its availability can vary depending on device configuration.
This menu item may be available for all users in future versions.



Menu : SYSt
Item : c7
Values : submenu **di**

This setting allows you to adjust the brightness of individual digits. Each digit is adjusted separately, with values ranging from values **0** to **E** (values **0** - **9**, then values **A** - **E**). This is useful in cases where certain digits are brighter than other, and you need to balance their brightness.

Proceed to enter the submenu **di** by pressing **PB2L** or **OK** on IR remote controller:

Submenu **di**

Value	Description	Range
00. :00.	Setting of display brightness of individual digits (set value is blinking)	0 - E
00. :00. 00.		
00. :00. :00.		

11.9.1. Settings Procedure

1. Enter the submenu **di** by pressing **PB2L** or **OK** on IR remote controller. The first digit is blinking.
2. Set your desired brightness ranging from **0** (no change to brightness) to **E** (maximal brightness reduction):
 - To increase the set value (increase brightness reduction), press the **PB2** button or **+** button on IR remote controller.
 - To decrease the set value, press the **PB1** button or **-** button on IR remote controller.
3. If you are satisfied with the set brightness, press the **PB2L** or **OK** on IR remote controller to move to next digit. The next digit is blinking. Repeat the procedure.
4. If you are satisfied with the brightness of all digits, press the the **PB2L** or **OK** on IR remote controller until the end. It will automatically save the set values and return to SYSt menu item **c7:di**.

11.10. Individual Dot Brightness Setting

✓ Added in version r8.02.



This menu item may not be available to all users. Its availability can vary depending on device configuration.
This menu item may be available for all users in future versions.



Menu : SYSt
Item : c8
Values : submenu do

This setting allows you to adjust the brightness of individual dots. Each dot is adjusted separately, with values ranging from values 0 to E (values 0 - 9, then values A - E). This is useful in cases where certain dots are brighter than other, and you need to balance their brightness.

Proceed to enter the submenu do by pressing **PB2L** or **OK** on IR remote controller:

Submenu do

Value	Description	Range
·00.:00.	Setting of display brightness of individual dots (digit is blinking – see table below for more info)	0 - E
·00.:00. °°.		
·00.:00.:00.		

11.10.1. Settings Procedure

1. Enter the submenu do by pressing **PB2L** or **OK** on IR remote controller. The first digit is blinking (this indicated setting of brightness of the first dot).

For more information of what digits represents what dot, please see the figure or table below.

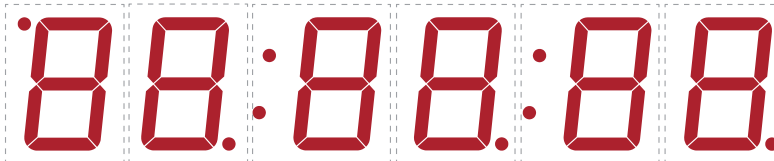

2. Set your desired brightness of dot ranging from 0 (no change to brightness) to E (maximal brightness reduction):
 - To increase the set value (increase brightness reduction), press the **PB2** button or **+** button on IR remote controller.
 - To decrease the set value, press the **PB1** button or **-** button on IR remote controller.
3. If you are satisfied with the set brightness, press the **PB2L** or **OK** on IR remote controller to move to next dot setting. The next digit representing next dot is blinking. Repeat the procedure.
4. If you are satisfied with the brightness of all dots, press the the **PB2L** or **OK** on IR remote controller until the end. It will automatically save the set values and return to SYSt menu item c8:do.

Digits > Dots

Flashing Digit	Set Dot
First digit	Dot on top left corner (AM / PM indication)
Second digit	Dot on bottom right corner next to second digit
Third digit	First colon
Fourth digit	Dot on bottom right corner next to fourth digit
Fifth digit ^[1]	Second colon (for display configuration 4 + 2 digits no colon is displayed)
Sixth digit	Dot on bottom right corner next to sixth digit

^[1] Only for display configuration of 4 + 2 or 6 digits.

12 Power modes

✔ Added in version r7.14.

The digital clock supports power OFF and power SAVE modes. These are modes where the clock display is turned off to ensure lower power consumption.

Power Modes Summary

Menu Item	Description	Value(s)
P1	Power OFF	0, 1
P2	Power SAVE	0, 1
P3	Power SAVE Mode Start Time	St (submenu)
P4	Power SAVE Mode End Time	Ed (submenu)

12.1. Power OFF



Menu : Powr
 Item : P1
 Values : 0, 1

This mode ensures that the clock display is permanently off. The clock does not respond to any press of remote controller buttons or push-buttons.

Activation via menu:

Value(s)	Description
0	No function
1	Immediate switching off of the clock display

Alternatively for IR remote controller , activation of power off mode can be done by long pressing the **DISP** from **Main screens** (display of time, date, stopwatch, ...).

After confirmation, the display will immediately switch to Power OFF mode and turns off. Entry into this mode is indicated by displaying **OFF** for 1 second.

The mode is exited by long pressing the **DISP** button on the IR remote controller or by long pressing **PB1** or **PB2** . The display is then switched on again.

Alternatively, activation can be done via Web interface tab **Mode** .

- Overview
- Network
- Time
- Time zone
- Mode
- Sensors
- Supervision
- General
- Command
- Authentication
- Logout

Mode

General

Display brightness	<input type="text" value="2"/>
Time display format	<input type="text" value="24"/>
Display alternating mode	<input type="text" value="Continuous display time"/>
IR auto lock time	<input type="text" value="U"/>
Time display zeros	<input type="text" value="Yes"/>
Date display zeros	<input type="text" value="Yes"/>
Display current derating	<input type="text" value="no derating"/>
Light measurement correction	<input type="text" value="no correction"/>
Stopwatch keyboard connected	<input type="text" value="No"/>

Display alternating mode - display intervals

Time	<input type="text" value="6 s"/>
Date	<input type="text" value="3 s"/>
Calendar week	<input type="text" value="off"/>
Temperature 1	<input type="text" value="off"/>
Humidity 1	<input type="text" value="off"/>
Pressure 1	<input type="text" value="off"/>
Temperature 2	<input type="text" value="off"/>
Humidity 2	<input type="text" value="off"/>
Pressure 2	<input type="text" value="off"/>

Power

Power OFF	<input type="text" value="No"/>
Power save mode	<input type="text" value="Enable"/>
Save mode start	<input type="text" value="08:01"/>
Save mode end	<input type="text" value="08:02"/>

12.2. Power SAVE



Menu : Powr
 Item : P2
 Values : 0, 1

An automatic mode where the clock display is switched off at set time interval. If one of the push-buttons or the IR remote controller is pressed, the display is briefly switched on. At this time the clock can be operated normally.

After 10 seconds have elapsed since the last press of the button or push-button, the clock display will switch off again.

Entry into this mode is indicated by the display of **SLP** for 1 second .

Activation of Power save mode:

Value(s)	Description
0	Power save mode disabled
1	Power save mode enabled

Alternatively, activation can be done via Web interface tab **Mode** .

- Overview
- Network
- Time
- Time zone
- Mode
- Sensors
- Supervision
- General
- Command
- Authentication
- Logout

Mode

General

Display brightness

Time display format

Display alternating mode

IR auto lock time

Time display zeros

Date display zeros

Display current derating

Light measurement correction

Stopwatch keyboard connected

Display alternating mode - display intervals

Time

Date

Calendar week

Temperature 1

Humidity 1

Pressure 1

Temperature 2

Humidity 2

Pressure 2

Power

Power OFF

Power save mode

Save mode start

Save mode end



Following start and end time submenus are accessible only if the Power save mode is activated.

12.2.1. Save mode start time



Menu : Powr
Item : P3
Values : St* (*accessible submenu*)

The Save mode start time can be set by this submenu:

Value(s)	Description	Range
HH	Setting of hour	Range 0–23
MM	Setting of minutes	Range 0–59

12.2.2. Save mode end time



Menu : Powr
Item : P4
Values : Ed* (*accessible submenu*)

The Save mode end time can be set by this submenu:

Value(s)	Description	Range
HH	Setting of hour	Range 0–23
MM	Setting of minutes	Range 0–59

13 Share Mode

✔ Added in version r8.0.



Available only for digital clock synchronized by Ethernet variant and/or with RS-485 option.

The sharing mode allows sharing of certain parameters, values and functions between multiple devices. It is assumed that for each shared parameter, there is one Master device and several Slave devices. The Master device sends the shared values, and Slave devices receive and apply them.

Currently, the following parameters can be shared:

- Display Mode
- Stopwatch
- Relay
- Brightness
- Screen
- Sensor
- Time





For an individual parameter, there must not be more than one control device on the common shared channel (UDP port or RS485). Otherwise, the subordinate clocks will display incorrect information or it may lead to erroneous behavior.

Share Mode Settings Summary

Menu Item	Description	Value(s)
E0	Interface Setting	0, 1
E1	UDP Port Setting	submenu Pt
E2	Sharing Display Mode (Default Display, Stopwatch)	0, 1, 2
E3	Sharing Stopwatch	0, 1, 2
E4	Sharing Relay	0, 1, 2
E5	Sharing Display Brightness	0, 1, 2
E6	Sharing Screen	0, 1, 2
E7	Sharing Time	0, 1, 2
10	Sharing Sensor 1	0, 1, 2
11	Sharing Sensor 2	0, 1, 2
20	Local Stopwatch Setting	0, 1

13.1. Interface Setting

-  **Menu :** ShrE
- Item :** E0
- Values :** 0, 1

 This setting is available only if the digital clock is Ethernet variant and also include RS-485 option.

Setting of the interface through which sharing will take place.

Value	Description
0	LAN
1	RS-485

13.2. UDP Port Setting

-  **Menu :** ShrE
- Item :** E1
- Values :** Pt* (accessible submenu)

 Available only if the clocks include Ethernet and LAN interface for sharing is selected (ShrE menu item E0 (Interface Setting) is set to value 0).

To set the UDP port value, enter the Submenu Pt and set your desired UDP port by following items. The UDP port is set in format `xyyy` , range: 1 – 65535 . The default port is 65533 .

Submenu Pt for setting the UDP port

Value	Description	Range
A	UDP Port, thousands setting	xx
b	UDP Port, units setting	yyy

 You cannot select a port currently used by another service. By default, ports 65532 and 65534 are occupied.

13.3. Sharing Display Mode (Default Display, Stopwatch)

-  **Menu :** ShrE
- Item :** E2
- Values :** 0, 1, 2

Sharing information on whether to display the main screen (time, date, etc.) or the stopwatch.

Value	Description
0	Disabled
1	Master

Value	Description
2	Slave

13.4. Sharing Stopwatch



Menu : ShrE
 Item : E3
 Values : 0, 1, 2

Sharing the stopwatch along with its mode and settings (counting direction, start value, etc.).



In order to display the correct stopwatch value, the Slave clock must be synchronized.

If the Slave clocks need to have different stopwatch settings, set the ShrE menu item 20 (Local Stopwatch Settings) to value **1** .

Value	Description
0	Disabled
1	Master
2	Slave

13.5. Sharing Relay



Menu : ShrE
 Item : E4
 Values : 0, 1, 2

Sharing the relay status (the Slave clock may not be equipped with REL option, but its virtual status can be shared).

Value	Description
0	Disabled
1	Master
2	Slave

13.6. Sharing Display Brightness



Menu : ShrE
 Item : E5
 Values : 0, 1, 2

Sharing the set display brightness.

The desired display brightness can be set in dISP menu item d1 (Display Brightness) .

Value	Description
0	Disabled

Value	Description
1	Master
2	Slave

13.7. Sharing Screen



Menu : ShrE
Item : E6
Values : 0, 1, 2

Direct screen sharing. Menu navigation and similar actions are also shared.

Value	Description
0	Disabled
1	Master
2	Slave

13.8. Sharing Time



Menu : ShrE
Item : E7
Values : 0, 1, 2



Available only for RS-485 Interface (ShrE menu item E0 set to value **1**).

Sharing time from Master clock to Slave clock.

In the Slave clocks, synchronization to this shared parameter can then be set in SYNC menu item o2 (Type of Synchronization) set to value **12**. Although it may not be as precise as direct synchronization from other sources.

Value	Description
0	Disabled
1	Master
2	Slave

13.9. Sharing Sensor 1



Menu : ShrE
Item : 10
Values : 0, 1, 2

Sharing values measured by sensor 1. In the Slave clocks, a virtual shared sensor 1 can then be set as sensor type in SENx menu item t1 (Sensor Type).

Value	Description
0	Disabled
1	Master
2	Slave

13.10. Sharing Sensor 2



Menu :	ShrE
Item :	11
Values :	0, 1, 2

Sharing values measured by sensor 2. In the Slave clocks, a virtual shared sensor 2 can then be set as sensor type in SENx menu item t1 (Sensor Type) .

Value	Description
0	Disabled
1	Master
2	Slave

13.11. Local Stopwatch Setting



Menu :	ShrE
Item :	20
Values :	0, 1

If this settings is disabled, the Slave clocks will not share stopwatch settings with Master clock.

Value	Description
0	Disabled
1	Enabled

13.12. Examples of Share Mode Settings

Sharing Stopwatch and Relays over LAN with Automatic Transition to Stopwatch

Connection Description

- Multiple clocks synchronized by NTP protocol (NTP / PoE / WiFi variant) connected to a common network.
- One Master clock with BRB10 connected, the rest Slave clocks with sirens connected to their relays.
- Source of synchronization of all clocks NTP server (e.g. pool.ntp.org)
- Default display of Time, when BRB is pressed, transition to Stopwatch display and starting the countdown of 5 minutes, relay on

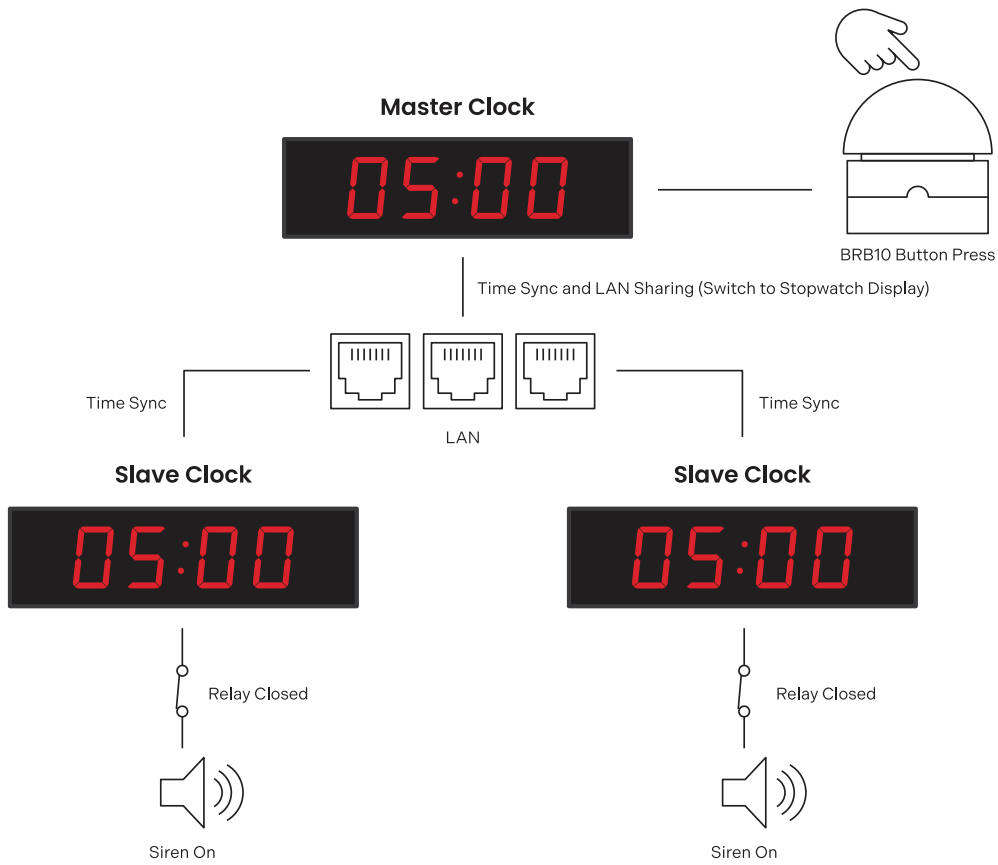
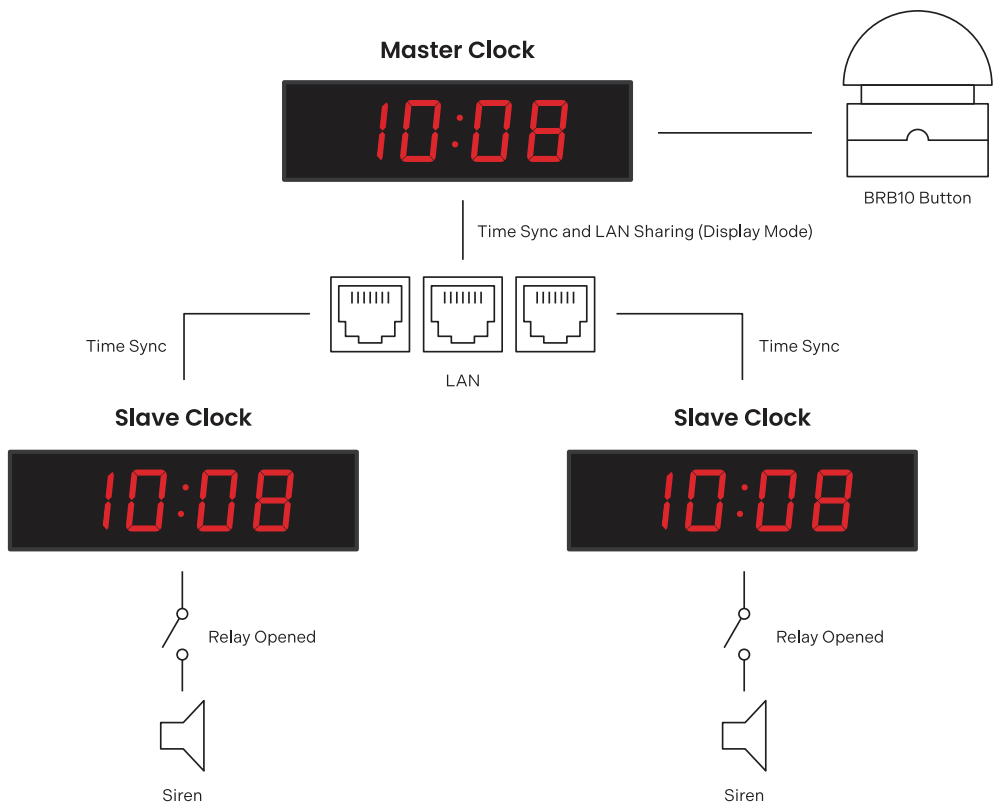

Master Clock Settings

Sharing Settings

Setting	Menu	Item	Value
Sharing Display Mode as Master	ShrE	E2	1
Sharing Stopwatch as Master	ShrE	E3	1
Sharing Relay as Master	ShrE	E4	1

Other Settings

Setting	Menu	Item	Value
Stopwatch in Countdown Mode	StoP	h1	2
Stopwatch Countdown Period 5 min	StoP	PrES	00:05
Relay Disconnect on Countdown (this setting is also available for variant without Relay option if Sharing Relay option is enabled in Master mode)	StoP	h4	C
External Keyboard Connection	StoP	h6	1
BRB10 Control Mode	StoP	h2	6

Slave Clock Settings

Sharing Settings

Setting	Menu	Item	Value
Sharing Display Mode as Slave	ShrE	E2	2
Sharing Stopwatch as Slave	ShrE	E3	2
Sharing Relay as Slave	ShrE	E4	2



For Sharing Stopwatch to work properly, all clocks must be synchronized (NTP server in this example), otherwise the slave clock will display --:--.

Sharing Time and Temperature via RS-485 from a Clock Synchronized by GPS Variant

Connection Description

- One clock synchronized by GPS variant with RS-485 option with two TP3/30 temperature sensors, other clocks synchronized by LGC variant with RS-485 option.
- GPS variant synchronized clock as Master clock with time and temperature measurement sharing on RS-485, other clocks as Slave clocks.
- Synchronization source:
 - Master: GPS
 - Slave: RS-485
- All clocks in automatic time, date and temperature display mode.

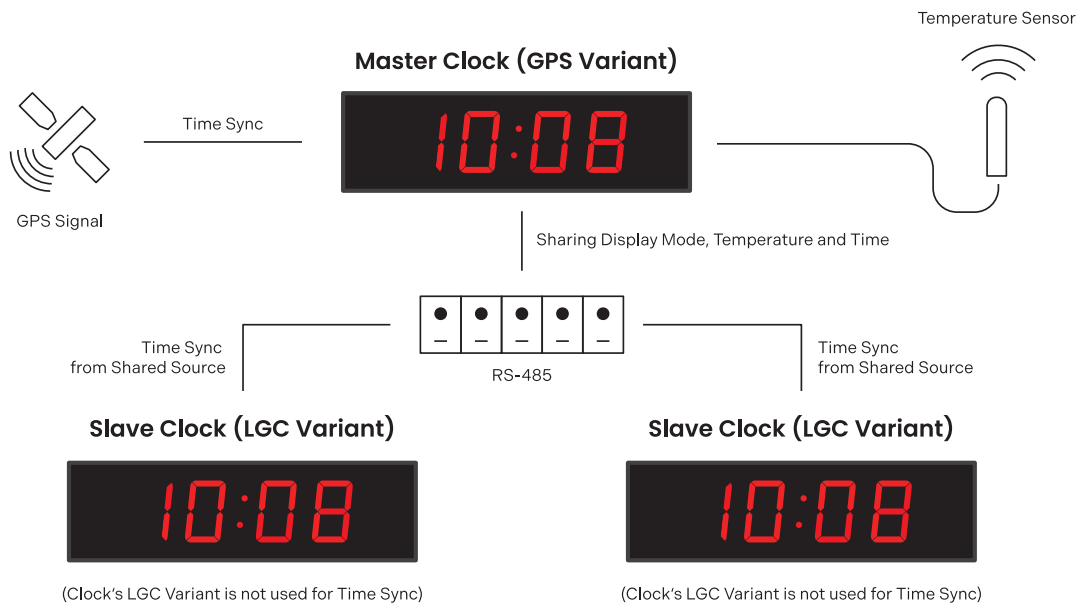

Master Clock Settings

Sharing Settings

Setting	Menu	Item	Value
Sharing Display Mode as Master	ShrE	E2	1
Sharing Time as Master	ShrE	E7	1
Sharing Sensor 1 as Master	ShrE	10	1

Slave Clock Settings

Sharing Settings

Setting	Menu	Item	Value
Sharing Display Mode as Slave	ShrE	E2	2
Sharing Time as Slave	ShrE	E7	2
Sharing Sensor 1 as Slave	ShrE	10	2

Other Settings

Setting	Menu	Item	Value
Time Synchronization According to Master Clock (this setting takes the synchronized time from Master clock synchronized by GPS variant instead of being synchronized by its LGC variant)	SYNC	o2	12
Setting the Sensor Type to Shared Sensor	SENx	t1	13

14 Local time calculation

14.1. According to Synchronization Source

This setting is suitable for digital clock synchronized by a DCF receiver or controlled by a master clock as SLAVE clock in a time distribution system. The internal timezone table is not used.

Item	Set Value(s)	Description
o1	A	Timezone is takes over according to the source of synchronization
o2	2-9, 11, A	Synchronization signal type
o4	0	MOBALine timezone is not used
o5	0	Timezone server is not used
d2	A	Display time and date according to source of synchronization including daylight saving time

14.2. According to MOBALine Timezones

This setting is suitable for digital clock controlled by a MASTER clock as a MOBALine SLAVE clock in a time distribution system with possibility to display different MOBALine timezones.

Item	Set Value(s)	Description
o1	A	Timezone is taken over according to the source of synchronization, the UTC time calculation is based on the MOBALine information
o2	4	MOBALine
o4	1-20	Selection of MOBALine timezone
d2	A	Display time and date according to chosen MOBALine timezone including daylight saving time

14.3. According to MOBA-NMS Preconfigured Timezones

This setting is suitable for NTP, PoE, WiFi and WiFi5 digital clock where several user defined timezones entries should be used. The timezone entries are preconfigured by means of the MOBA-NMS software.

Item	Set Value(s)	Description
o1	A	NTP protocol uses UTC timezone
o2	A	Automatic
o5	0	No timezone server is used

Item	Set Value(s)	Description
d2	U1–U7	Display time and date according to chosen preconfigured timezone entry including daylight saving time

14.4. According to Server MOBATIME

This setting is suitable for NTP, PoE, WiFi and WiFi5 digital clock controlled by MOBATIME NTP servers which supports the timezone server functionality.

Item	Set Value(s)	Description
o1	A	NTP protocol uses UTC time
o2	A	Automatic
o5	1–15	Selection of the time zone server time zone
d2	A	Display time and date according to chosen time zone server time zone including daylight saving time

14.5. According to Internal Timezone Table

This setting is suitable for autonomous digital clocks or in cases where the displayed time is needed in another timezone than provided by the synchronization source. Displayed time and date calculation is based on the internal timezone table or on the user-specific timezone parameters – see timezone table .

Item	Set Value(s)	Description
o1	0–64, A	According to the timezone in which the source of synchronization works (e.g. value 2 for DCF in west Europe, value A for NTP synchronization) Value A only for synchronization source working with UTC time
o2	1–11, A	Autonomous operation or any type of the synchronization signal
o4	0	MOBALine timezone is not used
o5	0	Timezone server is not used
d2	0–64, U	Display time and date by calculation from the UTC time according to chosen timezone including daylight saving time

15 Time Zones Table

Time zones are a system of dividing the Earth's surface into regions, each with its own unique time offset from UTC (Coordinated Universal Time) or GMT (Greenwich Mean Time) and which may have different rules for change seasonal time. This division allows for consistent and synchronized timekeeping across the globe.

No.	City / State	UTC Offset	DST	Standard → DST	DST → Standard
00	UTC GMT, Monrovia, Casablanca	0	No		
01	London, Dublin, Edinburgh, Lisbon	0	Yes	last Sunday March (01:00)	last Sunday October (02:00)
02	Brussels, Amsterdam, Berlin, Bern, Copenhagen, Madrid, Oslo, Paris, Rome, Stockholm, Vienna, Belgrade, Bratislava, Prague, Budapest, Ljubljana, Sarajevo, Sofia, Vilnius, Warsaw, Zagreb	+1	Yes	last Sunday March (02:00)	last Sunday October (03:00)
03	Athens, Helsinki, Riga, Tallinn	+2	Yes	last Sunday March (03:00)	last Sunday October (04:00)
04	Bucharest	+2	Yes	last Sunday March (03:00)	last Sunday October (04:00)
05	Pretoria, Harare, Kaliningrad	+2	No		
06	Amman	+2	Yes	last Thursdays March (23:59)	last Friday October (01:00)
07	UTC (GMT)	0	No		
08	Istanbul, Kuwait City, Minsk, Moscow, Saint Petersburg, Volgograd	+3	No		
09	Praia, Cape Verde	-1	No		
10	UTC (GMT)	0	No		
11	Abu Dhabi, Muscat, Tbilisi, Samara	+4	No		
12	Kabul	+4.5	No		
13	Adamstown (Pitcairn Is.)	-8	No		
14	Tashkent, Islamabad, Karachi, Yekaterinburg	+5	No		
15	Mumbai, Kolkata, Chennai, New Delhi, Colombo	+5.5	No		
16	Astana, Thimphu, Dhaka, Novosibirsk	+6	No		
17	Bangkok, Hanoi, Jakarta, Krasnoyarsk	+7	No		
18	Beijing, Hong Kong, Singapore, Taipei, Irkutsk	+8	No		
19	Tokyo, Seoul, Yakutsk	+9	No		
20	Gambier Island	-9	No		

No.	City / State	UTC Offset	DST	Standard → DST	DST → Standard
21	South Australia: Adelaide	+9.5	No		
22	Northern Territory: Darwin	+9.5	No		
23	Brisbane, Guam, Port Moresby, Vladivostok	+10	No		
24	Sydney, Canberra, Melbourne, Tasmania: Hobart	+10	Yes	1 st Sunday October (02:00)	1 st Sunday April (03:00)
25	UTC (GMT)	0	No		
26	UTC (GMT)	0	No		
27	Honiara (Solomon Is.), Magadan, Noumea (New Caledonia)	+11	No		
28	Auckland, Wellington	+12	Yes	last Sunday September (02:00)	1 st Sunday April (03:00)
29	Majuro (Marshall Is.), Anadyr	+12	No		
30	Azores	-1	Yes	last Sunday March (00:00)	last Sunday October (01:00)
31	Middle Atlantic	-2	No		
32	Brasilia	-3	Yes	3 rd Sunday October (00:00)	3 rd Sunday February (00:00)
33	Buenos Aires	-3	No		
34	Newfoundland	-3.5	Yes	2 nd Sunday March (02:00)	1 st Sunday November (02:00)
35	Atlantic Time (Canada)	-4	Yes	2 nd Sunday March (02:00)	1 st Sunday November (02:00)
36	La Paz	-4	No		
37	Bogota, Lima, Quito	-5	No		
38	New York, Eastern Time (US & Canada)	-5	Yes	2 nd Sunday March (02:00)	1 st Sunday November (02:00)
39	Chicago, Central Time (US & Canada)	-6	Yes	2 nd Sunday March (02:00)	1 st Sunday November (02:00)
40	Tegucigalpa, Honduras	-6	No		
41	Phoenix, Arizona	-7	No		
42	Denver, Mountain Time	-7	Yes	2 nd Sunday March (02:00)	1 st Sunday November (02:00)
43	Los Angeles, Pacific Time	-8	Yes	2 nd Sunday March (02:00)	1 st Sunday November (02:00)
44	Anchorage, Alaska (US)	-9	Yes	2 nd Sunday March (02:00)	1 st Sunday November (02:00)

No.	City / State	UTC Offset	DST	Standard → DST	DST → Standard
45	Honolulu, Hawaii (US)	-10	No		
46	Midway Is. (US)	-11	No		
47	Mexico City, Mexico	-6	Yes	1 st Sunday April (02:00)	last Sunday October (02:00)
48	Adak (Aleutian Is.)	-10	Yes	2 nd Sunday March (02:00)	1 st Sunday November (02:00)
49	UTC (GMT)	0	No		
50	UTC (GMT)	0	No		
51	UTC (GMT)	0	No		
52	UTC (GMT)	0	No		
53	UTC (GMT)	0	No		
54	Ittoqqortoormiit, Greenland	-1	Yes	last Sunday March (00:00)	last Sunday October (01:00)
55	Nuuk, Qaanaaq, Greenland	-3	Yes	last Saturday March (22:00)	last Saturday October (23:00)
56	Myanmar	+6.5	No		
57	Western Australia: Perth	+8	No		
58	Caracas	-4.5	No		
59	CET standard time	+1	No		
60	not used				
61	not used				
62	Baku	+4	Yes	last Sunday March (04:00)	last Sunday October (05:00)
63	UTC (GMT)	0	No		
64	UTC (GMT)	0	No		

Legend

- UTC :** Coordinated Universal Time
- UTC Offset :** Time difference from UTC time
- DST :** Daylight Saving Time
- Standard → DST :** Time change from Standard (Winter) Time to Summer Time
- DST → Standard :** Time change from Summer Time to Standard (Winter Time)



2nd last Sunday March (02:00)



switch over on the penultimate Sunday in March at 02:00 hours local time

16 Factory Reset Using Push-Buttons

✔ Added in version r7.16.

In an event that the clock gets to state that it does not work properly due to incorrect configuration or it is not possible to connect to the clock via Ethernet, the situation can be solved by invoking the factory settings from the clock menu Factory Reset (SYSt menu item c1). However, this can be a problem in very extreme cases where a misconfiguration has caused the clock to enter a reset loop. At this point, the clock menu **cannot be accessed** .

A new factory reset has also been added using a push-buttons press combination that should solve the problem.

16.1. Procedure

1. Connect the clock to power supply.
2. Press and hold **PB1** and **PB2** push-buttons at the same time.
3. Restart the clock by briefly pressing the reset button while holding **PB1** and **PB2** push-buttons at the same time.



The reset button is located inside of the clock on clock's control module located on PCB.

Remove the front panel from the clock body. The panel is held by magnets, relatively high force required to remove it.

The button is small yellow button labeled **RST** .

4. Hold both **PB1** and **PB2** push-buttons until **FAC** appears on the clock display (in approx. 5 seconds).
5. Release **PB1** and **PB2** push-buttons. The clock restarts to factory settings.

17 Firmware update

This section provides instruction and information on how to update the clock's firmware, which is the software that runs on the clock's internal processor. Firmware updates can bring new features, improvements and bug fixes.



The current firmware version as of 18.11.24: `r8.05`



When updating from version `r7.x` (version lower than `r8.0`) to version e.g. `r8.2`, you **must** first update to version `r8.0` (to download, go to the URL <https://docs.mobatime.cloud/ECO-SLH-DC/firmware/dc4-8.00.zip>). Only then can you update freely to any version. **This intermediate step is crucial!**

17.1. Firmware update via MOBA-NMS

For instruction about firmware update via MOBA-NMS, please visit www.mobatime.com/product/moba-nms/.

17.2. Firmware update via SNMP

1. Install TFTP server (e.g. `tftpd32`).
2. Allow access in Windows security window after opening TFTP server file.

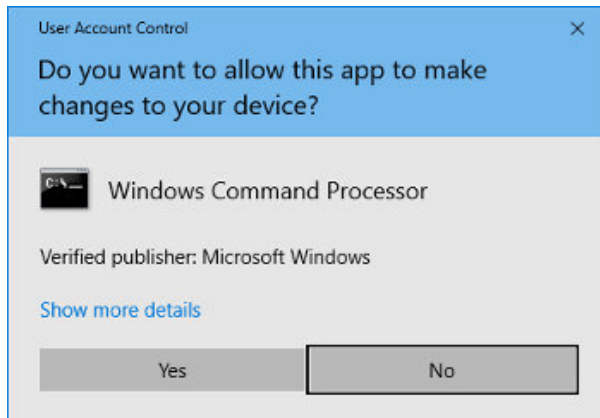

3. Place the firmware file named `device.upd` to folder from which your TFTP server serve files.
4. Open your SNMP manager software and load MIB file.
5. Find variable `mbnscCommandFirmwUpd` (OID = `.1.3.6.1.4.1.13842.6.2.7.4`) and set it to `devide.upd`.
6. In dependence of your TFTP server, information about update progress is displayed.
7. Wait about 1 minute after firmware download.
8. Check whether the firmware version is correct.



If the firmware version is not correct, it is necessary to repeat the procedure.

17.3. Firmware update via web server

1. Install TFTP server (e.g. `tftpd32`).
2. Allow access in Windows security window after opening TFTP server file.

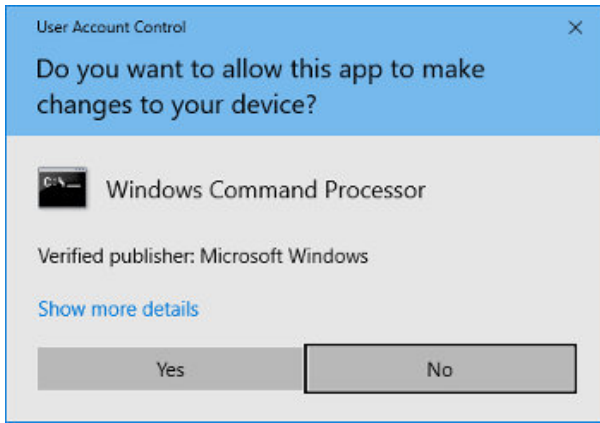

- Place the firmware file named `device.upd` to folder from which your TFTP server serve files.
- Open web interface of digital clock, which you want to update.



For instruction on accessing the web interface, please refer to the chapter **How to Get into Web Interface**

- In web interface, please navigate to section **Command**.
- Update will be invoked by pressing **Apply**.
- In dependence of your TFTP server, information about update progress is displayed.
- Wait about 1 minute after firmware download.
- Check whether the firmware version is correct.



If the firmware version is not correct, it is necessary to repeat the procedure.

17.4. Firmware update via USB

✓ **Added in version r7.07.**



Firmware update via USB is available only for LGC or GPS variant of digital clock.

- Upload the firmware file named `device.upd` to the USB drive.
- Connect the USB drive to the clock using the USB-C connector on the clock PCB.
- Open the clock menu and go to the SYSt system menu submenu.
- Setting item **c2** to value **1** will activate the firmware update process.

First step of the Firmware update process is to load the USB device.





The display will show a flashing **FU:xx**, where **xx** represents the result of the process:

0 : USB drive connected
-1 : USB drive not found

- If **FU: 0** is displayed, the file transfer can be started by pressing **OK** button on IR remote controller or by pressing **PB2L**.
- If the file on the USB disc is OK, the message stops flashing and **FU:xx** is displayed with only flashing colons, where **xx** already represserents the percentage progress of the file transfer.
- If the file is invalid for the device, **FU:-3** will flash or if the file is not found, **FU:-2** will flash.
- When the file transfer is complete, the **dONE** message is displayed and the clock resets after 2 seconds to complete the update process.



Until the file transfer starts, the menu can be exited by pressing  button on IR remote controller or by pressing .

If the file transfer process fails and the copy process does not complete, the clock must be manually reset, **as the clock control by the buttons or IR remote controller is ignored during the file transfer**.

[1] The ECO-DC and ECO-M-DC have USB-A instead of USB-C.

18 Clock specifications

These chapters provide detailed technical data about the clock's specifications and capabilities. These sections help users understand the clock's features, dimensions, power requirements and other important details.

18.1. Technical Parameters

Display	57.4	57.6	57x.6	100.4	100.6	100x.6
Digit Height [mm]	57	57 / 38	57	100	100 / 57	100
Number of Digits	4	4 + 2	6	4	4 + 2	6
Viewing Distance [m]		25			40	

Display Format	57.4	57.6	57x.6	100.4	100.6	100x.6
HH : MM DD. MM.	✓	×	×	✓	×	×
HH : MM ^{SS} DD. MM. ^{YY}	×	✓	×	×	✓	×
HH : MM : SS DD. MM. YY	×	×	✓	×	×	✓

Display Format	
Mains Powered	100-240 VAC / 50-60 Hz
PoE	IEEE 802.3af-Class 3
VDC Option	18-55 V (see VDC Voltage Table)
VDISP Option	Supply voltage depends on display color (see VDISP Voltage Table)

Power Consumption	57.4	57.6	57x.6	100.4	100.6	100x.6
Mains Powered	7	8	8	7	8	10
PoE	7	8	8	7	8	10

Power consumption is in VA.

Quartz Base and Running Reserve	
Running Reserve	96 hours by means of supercapacitor or 2 years with lithium battery
Accuracy	±0.1 s/day without synchronization (after 24 hours of synchronization at constant temperature)

Accuracy of Temperature Management (for TP3/30m Sensors)

Range -25 to +85 °C ±0.5 °C

Range -50 to +125 °C ±2.0 °C

Operating Environment

Temperature -5 to +55 °C

Humidity 0 to 95 % (without condensation)

Protection Degree IP 54

Weight [kg]

	57.4	57.6	57x.6	100.4	100.6	100x.6
Single Sided	2.6	3.3	3.5	4.7	5.8	6.5

Dimensions [mm]

W × H × D

	57.4	57.6	57x.6	100.4	100.6	100x.6
Single Sided	380	470	500	570	710	785
	150	150	150	220	220	220
	39	39	39	39	39	39

18.2. Diagram & dimensions

18.2.1. Without back cover

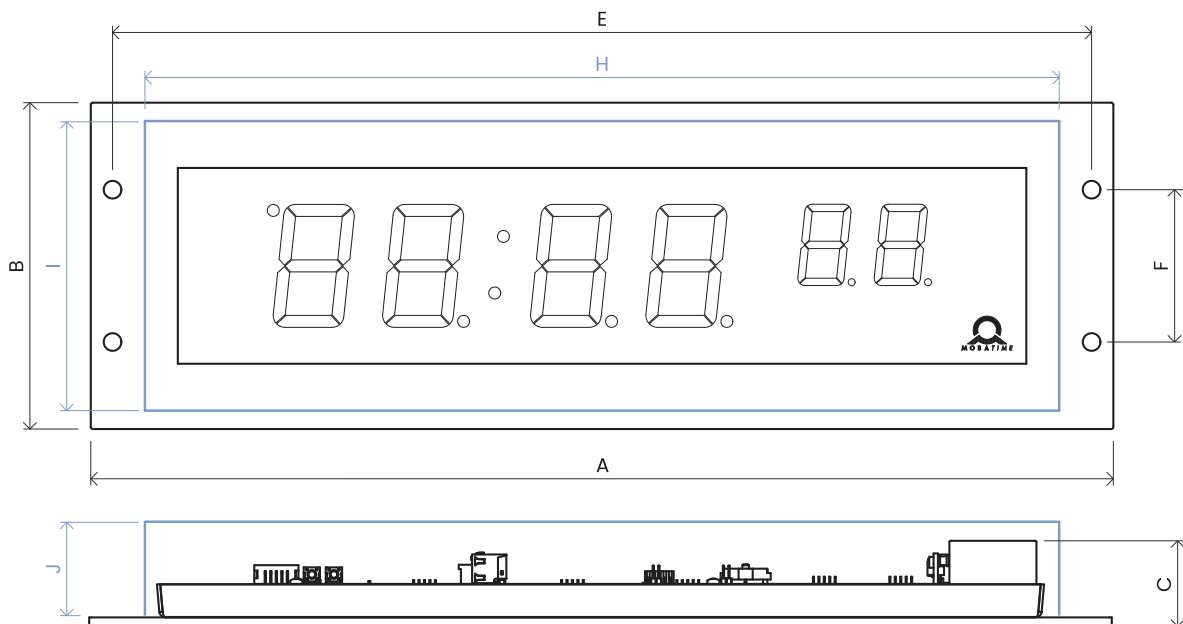

18.2.2. With back cover

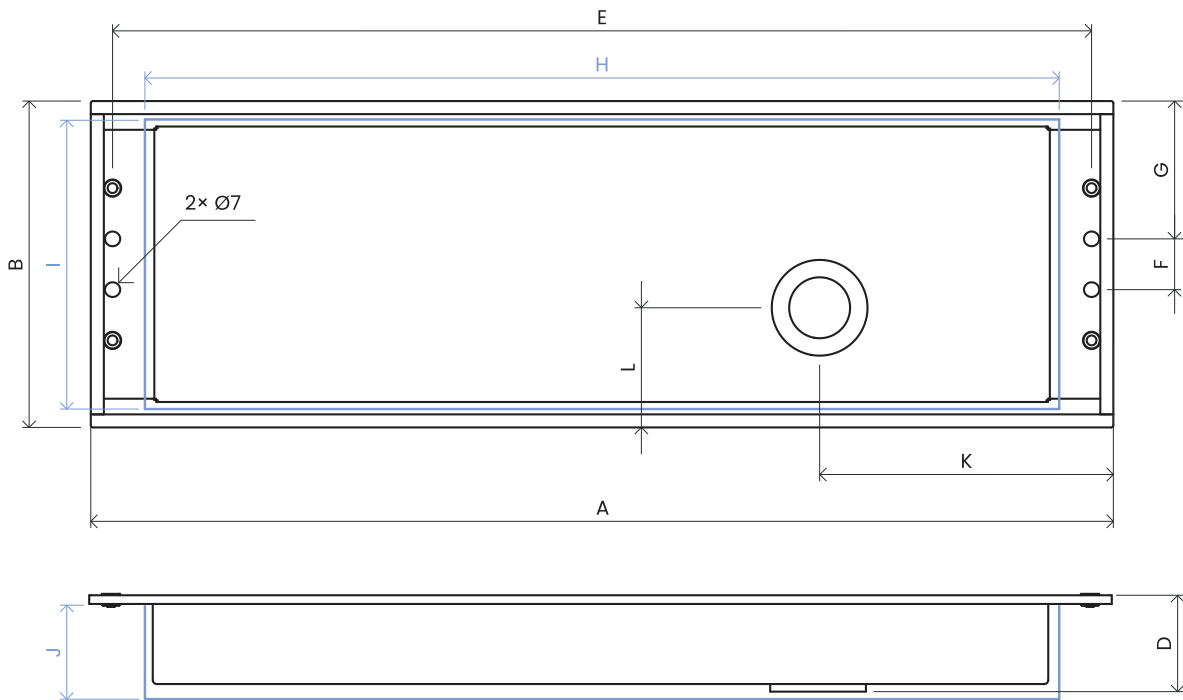

The Mounting Hole dimensions are indicated with Blue color.

18.2.3. Dimensions

Dimensions are in mm.

WO/ BC : Without Back Cover

W/ BC : With Back Cover

Index	57.4	57.6	57x.6	100.4	100.6	100x.6
A	380	470	500	570	710	785
B	150	150	150	220	220	220
C	39 (WO/ BC) 44 (W/ BC)	39 (WO/ BC) 44 (W/ BC)	39 (WO/ BC) 44 (W/ BC)	39 (WO/ BC) 44 (W/ BC)	39 (WO/ BC) 44 (W/ BC)	39 (WO/ BC) 44 (W/ BC)
E	360	450	480	550	690	765
F	70 (WO/ BC) 0 (W/ BC)	70 (WO/ BC) 0 (W/ BC)	70 (WO/ BC) 0 (W/ BC)	120 (WO/ BC) 0 (W/ BC)	120 (WO/ BC) 0 (W/ BC)	120 (WO/ BC) 0 (W/ BC)
G	N/A (WO/ BC) 75 (W/ BC)	N/A (WO/ BC) 75 (W/ BC)	N/A (WO/ BC) 75 (W/ BC)	N/A (WO/ BC) 110 (W/ BC)	N/A (WO/ BC) 110 (W/ BC)	N/A (WO/ BC) 110 (W/ BC)
H	325	415	445	520 (WO/ BC) 525 (W/ BC)	660	735 (WO/ BC) 740 (W/ BC)

Index	57.4	57.6	57x.6	100.4	100.6	100x.6
I	130	130	130	185 (WO/ BC) 190 (W/ BC)	185	185 (WO/ BC) 188 (W/ BC)
J	50	50	50	50	50	50
K	N/A (WO/ BC) 55 (W/ BC)	N/A (WO/ BC) 55 (W/ BC)	N/A (WO/ BC) 55 (W/ BC)	N/A (WO/ BC) 90 (W/ BC)	N/A (WO/ BC) 90 (W/ BC)	N/A (WO/ BC) 90 (W/ BC)
L	N/A (WO/ BC) 90 (W/ BC)	N/A (WO/ BC) 135 (W/ BC)	N/A (WO/ BC) 90 (W/ BC)	N/A (WO/ BC) 150 (W/ BC)	N/A (WO/ BC) 255 (W/ BC)	N/A (WO/ BC) 290 (W/ BC)

18.3. VDC option voltage table

7-Segment Display

Size	Red	Pure Green	Blue	White	Yellow	Green
57.4.	18-55	18-55	18-55	18-55	18-55	18-55
57.6.	18-55	18-55	18-55	18-55	18-55	18-55
57x.6.	18-55	18-55	18-55	18-55	18-55	18-55
75.4.	18-55	18-55	18-55	18-55	18-55	18-55
75.6.	18-55	18-55	18-55	18-55	18-55	18-55
75x.6.	18-55	18-55	18-55	18-55	18-55	18-55
100.4.	18-55	18-55	18-55	18-55	18-55	18-55
100.6.	18-55	18-55	18-55	18-55	18-55	18-55
100x.6.	18-55	18-55	18-55	18-55	18-55	18-55
180.4.	18-55	18-55	18-55	18-55	18-55	N/A
180.6.	18-55	18-55	18-55	18-55	18-55	N/A
180x.6.	18-55	18-55	18-55	18-55	18-55	N/A
250.4.	N/A	N/A	N/A	N/A	N/A	N/A
250x.6.	N/A	N/A	N/A	N/A	N/A	N/A

SMD LED Display

Size	Red SL	Pure Green SL	Blue SL	White SL	Yellow SL	Green SL
57.4.	18-55	18-55	18-55	18-55	18-55	N/A
57.6.	18-55	18-55	18-55	18-55	18-55	N/A
57x.6.	18-55	18-55	18-55	18-55	18-55	N/A
75.4.	18-55	18-55	18-55	18-55	18-55	N/A

Size	Red SL	Pure Green SL	Blue SL	White SL	Yellow SL	Green SL
75.6.	18-55	18-55	18-55	18-55	18-55	N/A
75x.6.	18-55	18-55	18-55	18-55	18-55	N/A
100.4.	18-55	18-55	18-55	18-55	18-55	N/A
100.6.	18-55	18-55	18-55	18-55	18-55	N/A
100x.6.	18-55	18-55	18-55	18-55	18-55	N/A
180.4.	18-55	18-55	18-55	18-55	18-55	N/A
180.6.	18-55	18-55	18-55	18-55	18-55	N/A
180x.6.	18-55	18-55	18-55	18-55	18-55	N/A
250.4.	18-55	25-55	26-55	25-55	18-55	N/A
250x.6.	18-55	25-55	26-55	25-55	18-55	N/A

Voltage is in V.

18.4. VDISP option voltage table

7-Segment Display

Size	Red	Pure Green	Blue	White	Yellow	Green
57.4.	12	14	14	14	12	12
57.6.	12	14	14	14	12	12
57x.6.	12	14	14	14	12	12
75.4.	12	14	14	14	12	12
75.6.	12	14	14	14	12	12
75x.6.	12	14	14	14	12	12
100.4.	12	14	14	14	12	12
100.6.	12	14	14	14	12	12
100x.6.	12	14	14	14	12	12
180.4.	18	24	25	24	18	N/A
180.6.	18	24	25	24	18	N/A
180x.6.	18	24	25	24	18	N/A
250.4.	N/A	N/A	N/A	N/A	N/A	N/A
250x.6.	N/A	N/A	N/A	N/A	N/A	N/A

SMD LED Display

Size	Red SL	Pure Green SL	Blue SL	White SL	Yellow SL	Green SL
57.4.	15	18	18	18	15	N/A
57.6.	15	18	18	18	15	N/A
57x.6.	15	18	18	18	15	N/A
75.4.	15	18	18	18	15	N/A
75.6.	15	18	18	18	15	N/A
75x.6.	15	18	18	18	15	N/A
100.4.	15	18	18	18	15	N/A
100.6.	15	18	18	18	15	N/A
100x.6.	15	18	18	18	15	N/A
180.4.	15	18	18	18	15	N/A
180.6.	15	18	18	18	15	N/A
180x.6.	15	18	18	18	15	N/A
250.4.	18	26	26	26	18	N/A
250x.6.	18	26	26	26	18	N/A

Voltage is in V.

18.5. LGC variant voltage table

Type of Slave Line	Voltage Range
MOBALine	5–30 VAC
Impulse, CODE	±12–30 V
IRIG-B	0.2–2 Vpp

19 Frequently asked questions

Here you will find answers to frequently asked questions.

19.1. General Questions

How to exit Power OFF mode? >

To exit Power OFF mode, either press push-button **PB1L** or **PB2L** , or **DISP** button on IR remote controller.

How to reset the digital clock to factory settings? >

If the clock is fully operational , enter Factory Reset chapter in **SYSt menu item c1** . Set the value to **1** which proceeds to enter the Submenu for Factory Reset. If you set the value to **1** , the **FAC** inscription will flash on display and the clock will reset to factory settings.

If the clock is not responding or has entered a reset loop , you need to do the Factory Reset Using Push-Buttons .

19.2. Local time calculation Questions

I have digital clock synchronized by a DCF receiver or controlled by a MASTER clock. How to configure the calculation of local time? >

Internal timezone table is not used. To show correct local time, set following items to values:

1. Navigate to SYNC menu item **o1** and set it to value **A** . That ensures the timezone is taken over according to the source of synchronization.
2. Navigate to SYNC menu item **o2** and set it to value **2-9** , **11** or **A** (autodetection). Select your synchronization type.
3. Navigate to SYNC menu item **o4** and disable the MOBALine timezone (set value **0**).
4. Navigate to SYNC menu item **o5** and disable the MOBATIME server timezone (set value **0**).
5. Navigate to DISP menu item **d2** and set it to value **A** (automatically set timezone). Time and date is displayed according to source of synchronization including daylight saving time.

I have digital clock controlled by a MASTER clock as MOBALine SLAVE clock and I want to use MOBALine timezones. > How to configure the calculation of local time?

To show correct local time, set following items to values:

1. Navigate to SYNC menu item **o1** and set it to value **A** . That ensures the timezone is taken over according to the source of synchronization and the UTC time calculation is based on the MOBALine information.
2. Navigate to SYNC menu item **o2** and set it to value **4** (MOBALine synchronization type).
3. Navigate to SYNC menu item **o4** and set your **desired MOBALine timezone** (values 1–20).
4. Navigate to DISP menu item **d2** and set it to value **A** (automatically set timezone). Time and date is displayed according to chosen MOBALine timezone including daylight saving time.

I have NTP, PoE, WiFi or WiFi5 variant of digital clock controlled by MOBATIME NTP servers. How to configure the calculation of local time? >

To show correct local time, set following items to values:

1. Navigate to SYNC menu item **o1** and set it to value **A** (automatically set timezone). NTP protocol then uses UTC time.
2. Navigate to SYNC menu item **o2** and set it to value **A** (autodetection).
3. Navigate to SYNC menu item **o5** and set your **desired MOBALine timezone** (values 1–15).
4. Navigate to DISP menu item **d2** and set it to value **A** (automatically set timezone). Time and date is displayed according to chosen MOBATIME server timezone including daylight saving time.

I need to display another timezone than timezone provided by the synchronization source. How to set the desired timezone? >

To set desired timezone, set following items to values:

1. Navigate to SYNC menu item **o1** and set it to value **0–64** or **A** (automatically set timezone). Set the value according to the timezone in which the source of synchronization works (e.g. value 2 for DCF in west Europe or value A for NTP synchronization).
Value A only for synchronization working with UTC time.
2. Navigate to SYNC menu item **o2** and set it to value **1–11** or **A** (autodetection). Select your synchronization type.
3. Navigate to SYNC menu item **o4** and disable the MOBALine timezone (set value **0**).
4. Navigate to SYNC menu item **o5** and disable the MOBATIME server timezone (set value **0**).
5. Navigate to DISP menu item **d2** and set it to value **0–64** or **A** (automatically set timezone). Time and date is displayed according to calculation from the UTC time according to desired timezone including daylight saving time.



*Headquarters/Production
Sales Worldwide*

Tel. +41 34 432 46 46 | Fax +41 34 432 46 99
moserbaer@mobatime.com | www.mobatime.com

Sales Switzerland

MOBATIME AG | Stettbachstrasse 5 | CH-8600 Dübendorf
Tel. +41 44 802 75 75 | Fax +41 44 802 75 65
info-d@mobatime.ch | www.mobatime.ch

MOBATIME SA | En Budron H 20 | CH-1052 Le Mont-sur-Lausanne
Tél. +41 21 654 33 50 | Fax +41 21 654 33 69
info-f@mobatime.ch | www.mobatime.ch

Sales Germany/Austria

BÜRK MOBATIME GmbH
Postfach 3760 | D-78026 VS-Schwenningen
Steinkirchring 46 | D-78056 VS-Schwenningen
Tel. +49 7720 / 85 35 - 0 | Fax +49 7720 / 85 35 - 11
buerk@buerk-mobatime.de | www.buerk-mobatime.de