

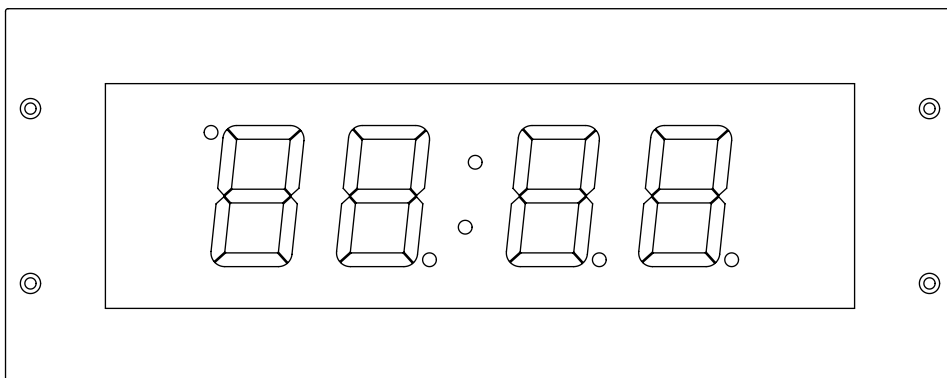

User Manual

ECO-SLH-DC

Stainless Steel Indoor Digital Clock



Scan the QR code or enter following URL to get the latest version:
<https://docs.mobatime.cloud/ECO-SLH-DC>

Regulations and Certification

The device fulfils the requirements of the following standards:

| | |
|----------------------------|--|
| Electrical safety : | EN 62368-1 ED.2 |
| EMC : | EN 55032 ED.2; EN 55035; EN 50121-4 ED.4 |

This product was developed and produced with the following EU directives:

| | |
|------------------|--|
| EMC : | Electromagnetic compatibility directive 2014/30/EU |
| LVD : | Low voltage directive 2014/35/EU |
| RED : | Radio equipment directive 2014/53/EU |
| RoHS II : | Restriction of the use of certain hazardous substances directive 2011/65/EU |
| WEEE : | Waste electrical and electronic equipment directive 2012/19/EU |
| REACH : | Chemical substance directive ES 1907/2006 |

See Conformity for the declaration of conformity of this specific product. This product may offer a CB test certificate on request.



Important Notes

1. Please read and follow the safety information in this document before operating the product. We cannot guarantee that no accidents or damage will occur to improper use of this product. Please use this product with care and operate at your own risk.
2. We are not liable for any direct or indirect damage caused by the use of this document or the said product.
3. This product must be connected and installed by qualified electrician who is familiar with the relevant regulations (e.g. VDE).
4. The information in this document is subject to change without notice. The latest version of this document is available for download at <https://docs.mobatime.cloud/ECO-SLH-DC/user-manual/pdf> .
5. The product firmware is continuously being optimized and supplemented with new options. The latest firmware is available for download at <https://docs.mobatime.cloud/ECO-SLH-DC/firmware/> .
6. This User Manual has been composed with the utmost care to explain all the details to ensure a safe and stable operation of this product. Nevertheless, if question arise or error appear, feel free to contact support.
7. No part of this document or the said product may be reproduced in any form or by any means or used to make any derivative such as translation, transformation, or adaption without permission from ELEKON, s.r.o., Brněnská 364/17, Vyškov 682 01 / CZECH REPUBLIC.
8. Copyright © 2026 ELEKON, s.r.o., Brněnská 364/17, Vyškov 682 01 / CZECH REPUBLIC. All rights reserved.

Table of Contents

| | | |
|-----------|--|-----------|
| 1. | Safety | 8 |
| 1.1. | Instructions and Symbols | 8 |
| 1.2. | General | 8 |
| 1.3. | Installation | 9 |
| 1.4. | Operation | 9 |
| 1.5. | Maintenance and Cleaning | 10 |
| 1.6. | Disposing | 10 |
| 1.7. | Warranty | 10 |
| 2. | Mounting | 11 |
| 2.1. | Flush mounting | 11 |
| 2.2. | Cable Connection | 13 |
| 3. | Clock Operation | 21 |
| 3.1. | Non-network Clock Operation | 21 |
| 3.2. | Network Clock Operation | 26 |
| 4. | Settings | 35 |
| 4.1. | Control | 35 |
| 4.2. | Navigation scheme | 36 |
| 4.3. | Web Interface | 39 |
| 5. | Display Settings | 49 |
| 5.1. | Display Brightness | 49 |
| 5.2. | Timezone of Time and Date | 50 |
| 5.3. | Time Constants for Automatic Data Switching Over | 51 |
| 5.4. | 12-Hour Format | 52 |
| 5.5. | Time with Leading Zero | 53 |
| 5.6. | Date with Leading Zero | 54 |
| 5.7. | Clock Address for IR Remote Controller | 54 |
| 5.8. | IR Remote Controller Auto-Lock | 55 |
| 5.9. | Remote Control Lock | 56 |
| 6. | Second Line Display Settings | 58 |
| 6.1. | Time Constants for Automatic Data Switching Over | 58 |
| 6.2. | 12-Hour Format | 60 |
| 6.3. | Time with Leading Zero | 61 |
| 6.4. | Date with Leading Zero | 61 |
| 7. | Synchronization Settings | 63 |
| 7.1. | Timezone of Synchronization Source | 63 |
| 7.2. | Type of Synchronization | 64 |
| 7.3. | Master Clock Time Zones | 65 |
| 7.4. | Protocol for RS-485 Communication | 66 |

| | | |
|------------|---|------------|
| 7.5. | Clock Address for Serial Protocols | 67 |
| 7.6. | Modulation Speed for RS-485 | 67 |
| 7.7. | Transmission Parameters for RS-485 | 68 |
| 7.8. | Timeout for Indication of State without Synchronization | 69 |
| 7.9. | Offset of Displayed Time | 70 |
| 8. | Network Settings | 72 |
| 8.1. | IP Mode | 73 |
| 8.2. | Communication Mode | 73 |
| 8.3. | DHCPv4 Mode | 74 |
| 8.4. | IP Address | 75 |
| 8.5. | Subnet Mask | 75 |
| 8.6. | Default Gateway | 76 |
| 8.7. | Multicast Address | 76 |
| 8.8. | Unicast NTP Address | 77 |
| 8.9. | NTP Polling Interval | 78 |
| 8.10. | Address Autoconfiguration (SLAAC) | 78 |
| 8.11. | DHCPv6 Mode | 79 |
| 8.12. | WiFi Mode | 79 |
| 8.13. | Multicast Mode for Configuration of Digital Clock | 80 |
| 8.14. | SNMP Protocol | 80 |
| 8.15. | Web Server | 81 |
| 8.16. | Web Server Security Mode | 81 |
| 8.17. | Link Local Address | 82 |
| 8.18. | Autoconfiguration SLAAC | 83 |
| 8.19. | First Address from DHCPv6 | 84 |
| 8.20. | Manually Set IPv6 Address | 85 |
| 8.21. | Prefix for Manually Set IPv6 Address | 86 |
| 8.22. | Gateway from Autoconfiguration SLAAC | 87 |
| 8.23. | MAC Address | 88 |
| 9. | Sensor Settings | 89 |
| 9.1. | Sensor Type | 90 |
| 9.2. | Input Number for Sensor One-Wire | 90 |
| 9.3. | Temperature Sensor | 91 |
| 9.4. | Humidity Sensor | 93 |
| 9.5. | Pressure Sensor | 95 |
| 9.6. | LAN Sensor | 98 |
| 10. | Stopwatch Settings | 100 |
| 10.1. | Stopwatch Start Time | 100 |
| 10.2. | Stopwatch End Time | 101 |
| 10.3. | Counting Direction | 102 |
| 10.4. | Control Mode | 103 |
| 10.5. | Counting Unit | 111 |
| 10.6. | Contact Closing | 112 |
| 10.7. | External Keyboard Connection | 112 |

| | | |
|------------|---|------------|
| 10.8. | Timeout to Switch to Default Display for BRB | 113 |
| 10.9. | BRB10 Connection | 113 |
| 10.10. | Stopwatch Start Time (2nd Input) | 114 |
| 10.11. | External Button Input Active Level | 115 |
| 10.12. | Display Blink | 116 |
| 10.13. | Code Blue | 118 |
| 11. | Time & Date Settings | 119 |
| 11.1. | Time | 119 |
| 11.2. | Date and Year | 120 |
| 12. | Power modes | 122 |
| 12.1. | Power OFF | 122 |
| 12.2. | Power SAVE | 124 |
| 13. | Share Mode | 127 |
| 13.1. | Interface Setting | 128 |
| 13.2. | UDP Port Setting | 128 |
| 13.3. | Sharing Display Mode (Default Display, Stopwatch) | 129 |
| 13.4. | Sharing Stopwatch | 129 |
| 13.5. | Sharing Relay | 130 |
| 13.6. | Sharing Display Brightness | 131 |
| 13.7. | Sharing Screen | 131 |
| 13.8. | Sharing Time | 132 |
| 13.9. | Sharing Sensor 1 | 132 |
| 13.10. | Sharing Sensor 2 | 133 |
| 13.11. | Local Stopwatch Setting | 133 |
| 13.12. | Examples of Share Mode Settings | 134 |
| 14. | System Settings | 138 |
| 14.1. | Diagnostic tools | 138 |
| 14.2. | Factory Reset | 143 |
| 14.3. | Firmware Update via USB Process Settings | 144 |
| 14.4. | Clock Address for IR Remote Controller | 145 |
| 14.5. | IR Remote Controller Auto-Lock | 145 |
| 14.6. | Remote Control Lock | 146 |
| 14.7. | Display Brightness Derating | 147 |
| 14.8. | Light Sensor Correction | 148 |
| 14.9. | Individual Digit Brightness Setting | 149 |
| 14.10. | Individual Dot Brightness Setting | 150 |
| 15. | Local time calculation | 152 |
| 15.1. | According to Synchronization Source | 152 |
| 15.2. | According to MOBALine Timezones | 152 |
| 15.3. | According to MOBA-NMS Preconfigured Timezones | 152 |
| 15.4. | According to Server MOBATIME | 153 |

| | | |
|------------|---|------------|
| 15.5. | According to Internal Timezone Table | 153 |
| 16. | Timezones Table | 154 |
| 17. | Factory Reset to Default Values | 157 |
| 17.1. | Factory Reset Using Menu | 157 |
| 17.2. | Factory Reset via Web Interface | 157 |
| 17.3. | Factory Reset Using Push-Buttons | 157 |
| 18. | Firmware update | 159 |
| 18.1. | Firmware update via MOBA-NMS | 159 |
| 18.2. | Firmware update via SNMP | 159 |
| 18.3. | Firmware update via web server | 159 |
| 18.4. | Firmware update via USB | 160 |
| 19. | Clock specifications | 162 |
| 19.1. | Basic Data | 162 |
| 19.2. | Diagram & Dimensions | 163 |
| 19.3. | VDC Option Voltage Table | 165 |
| 19.4. | VDISP Option Voltage Table | 165 |
| 19.5. | LINES Input Voltage Range for Control Signals | 166 |
| 20. | Frequently asked questions | 167 |
| 20.1. | General Questions | 167 |
| 20.2. | Local Time Calculation Questions | 167 |

1 Safety



Read the safety instructions carefully and follow all the instructions. This ensures safe and reliable operation of this device.

1.1. Instructions and Symbols

Symbols used throughout this document and their meaning are as follows:



A note or important information.



Answer to a possible question. Contact information.



Keep away from children and people with limited physical, sensory, or mental capacities.



Action needs to be taken.



Connect device to earth ground.



More information included in the manual. It also indicates navigation in the clock menu.



Disconnect mains power before doing anything.



An example or a hint.



Additional references or information.



Attention of electrical shocks.



Surface may be hot.



Item is flammable.



A warning, be cautious.



Recyclable materials.



Do not put in trash.

1.2. General



For safety and licensing reasons, unauthorized modifications and/or changes to the product is prohibited. Maintenance, adjustments or repairs may only be carried out by the factory (copyright holder).



This product is not a toy; it does not belong in the hands of children. Mount or place the product so that it cannot be reached by children. Children may try to insert objects into the product. The product will not only be damaged, but there is also a risk of injury, as well as danger to life through electric shock.



Never open the housing of this product, for it poses mortal danger from electric shock or may even cause a fire.

Keep packaging such as plastic films away from children. There is the risk of suffocation of misused.



Use caution with the product, knocks, blows, or even falls from a low height can damage it.



In industrial facilities, the accident prevention regulations of the trade associations for electrical systems and equipment must be observed.

Do not use the product if it is damaged. It can be assumed that safe operation is no longer possible, if:

- The product has visible damage.
- The product is not working properly (thick smoke or a burning smell, audible crackling noise, discoloration of the product or surrounding areas).
- The product was stored under adverse conditions.
- Tough conditions during transport.



Improper handling of this product operated on the mains voltage can cause mortal danger from electric shock!



Interconnection or combining equipment bearing a CE label does not inevitably result in a system that conforms with the safety regulations. Integrators will have to reassess the new product's compliance according to the locally valid directives. See section Conformity for more information on certifications of this product.

1.3. Installation

This product must be connected and installed by a qualified electrician who is familiar with the relevant regulations (e.g. VDE).



Never plug the product into voltage / power supply immediately after it has been moved from cold into warm environment (e.g. during / after transport / unboxing). The resultant condensed water may damage the product or may cause electric shock.



Allow the product reach the ambient temperature. Wait until the condensation has evaporated, this can take a few hours. Only then can the product be connected to the voltage / current supply and put into operation.



This product may have screw terminals with open electrical contacts. It is essential to ensure that the connection is made only when no voltage / current is applied. Secure the power supply to prevent accidental reconnection. Verify the absence of voltage using an appropriate meter.



The power supply line must be protected with a residual current circuit breaker (RCCB) with a trip current ≤ 30 mA.



Always connect earth ground to the device at the indicated protective earth terminal (PE or earth symbol indication).



Always unplug a power plug from the socket only at the intended gripping surface, pull the power plug not the cord from a power outlet. Wires may rip out and pose danger to life though electric shock.



Maintain sufficient cooling of the product according to its specifications.

1.4. Operation

Use the product in the specified environment. Use outside of the specifications can damage the product and/or stop any operation.

The product may not be exposed to extreme temperatures, direct sunlight or strong vibrations. Protect the product from moisture, dust and dirt.



Operation in environments with excessive dust, flammable gases, vapours or solvents is not permitted. It may cause explosion or fire.



Depending on the cooling type, the product housing may reach temperatures above 60 °C, which can burn the skin.

- Do not overload the product. Note the input / output voltage and currents as well as output powers indicated on the product.
- Depending on the input currents and input voltages, suitable connecting cables with appropriate cable diameter must be used. Only use the plugs and connectors supplied in the original packaging with the product.

1.5. Maintenance and Cleaning

- If the product and/or the connecting cable is damaged, do not touch it: there is mortal danger from electric shock! First, turn off the power supply to all poles of the product (turn off associated circuit breaker or remove the fuse, then turn off GFCI). Verify the absence of voltage using an appropriate meter.
- For the end consumer, the product is maintenance-free. Leave any maintenance to an expert. Repairs may only be done by the factory itself (copyright holder).
- For external cleaning one can use a clean, soft, dry cloth. Dust can be easily removed with a clean, soft brush and a vacuum cleaner.



Unplug all poles of the product from the operating voltage before cleaning.

- You can use cleaning / disinfection supplies on stainless steel frame for extra cleanliness.
- This product is equipped with fuses for protection against high voltage and high currents. Burned fuses may only be replaced by the factory itself (copyright owner).



Never bridge a fuse, it is a fire hazard and can cause a fatal electric shock.

1.6. Disposing



At the end of its lifecycle, do not dispose of this device in the regular household rubbish. Return it to the supplier who will dispose of it correctly.



The user is lawfully obligated to return unusable batteries. **Disposal of used batteries through household waste is prohibited!** Batteries which contain dangerous substances are labelled with a picture of crossed out trash bin. The symbol means that this product may not be disposed through household waste.

Unusable batteries can be returned free of charge at appropriate collection points of your waste disposal company or at shops that sell batteries. By doing so, you fulfil your legal responsibilities and help protect the environment.



This product was packed and stuffed with proper materials to protect it during transportation. Packaging materials can be recycled and should be disposed environmentally friendly.

1.7. Warranty

The device is intended for a normal operational environment according to the corresponding norm.

The following circumstances are excluded from the warranty:

- Inappropriate handling or interventions.
- Chemical influences.
- Mechanical defects.
- External environmental influences (natural catastrophes, etc.)



Repairs during and after warranty period are assured by the manufacturer.

2 Mounting

2.1. Flush mounting

There exists two basic possibilities of mounting: mounting of clock into wall niche and mounting into a panel. For both mounting is **very important** to prepare appropriate holes according to drawing and clock body.

2.1.1. Without back cover

1. For wall niche mounting, drill four anchoring holes into a wall of a diameter adequate to accommodate appropriate screws of 4 to 5 mm diameter. As a template for marking the position of holes the clock body can be used.
2. For panel mounting, drill four anchoring holes of 2.6 mm diameter into a panel to accommodate screws of 4 to 5 mm diameter. As a template for marking the position of holes the clock body can be used.
3. On mains powered clock connect the incoming conductors in accordance with the description on the power supply unit using WAGO or equivalent clamps.
4. Mount the connectors to the cable of the synchronization signal line, the temperature sensor cable, to the keyboard cable, Ethernet or to the RS-485 if these are used.



If the clock is synchronized by LGC variant, please navigate to Clock Operation [↗](#) → Non-Network Clock Operation [↗](#) to get detailed info about connection of various synchronization sources and receivers.

5. Push the synchronization line connector, the temperature sensor connector, the keyboard connector, Ethernet connector or the RS-485 jacks into the corresponding terminals on the control PCB.



Be careful not to swap terminals. Check the markings of the jack-plugs.

6. Put the clock into prepared hole. Check if any cables is not pinched between the clock body and hole / niche edges.

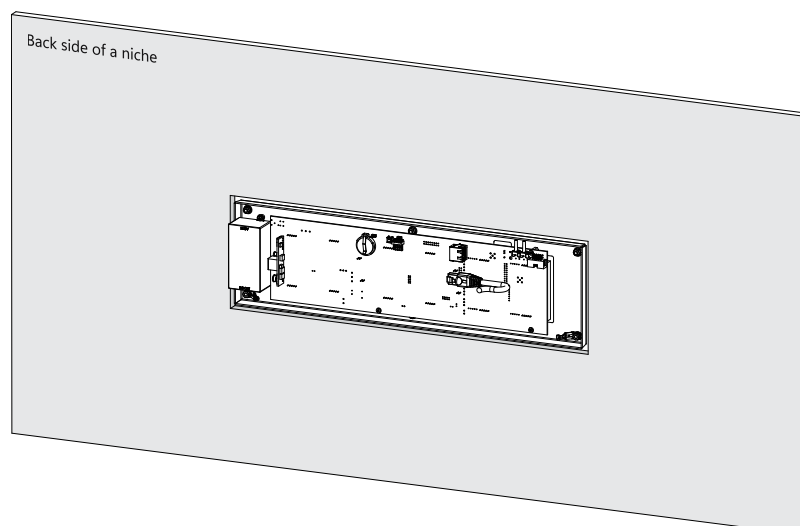

7. Fix the clock by four screws to panel / wall.

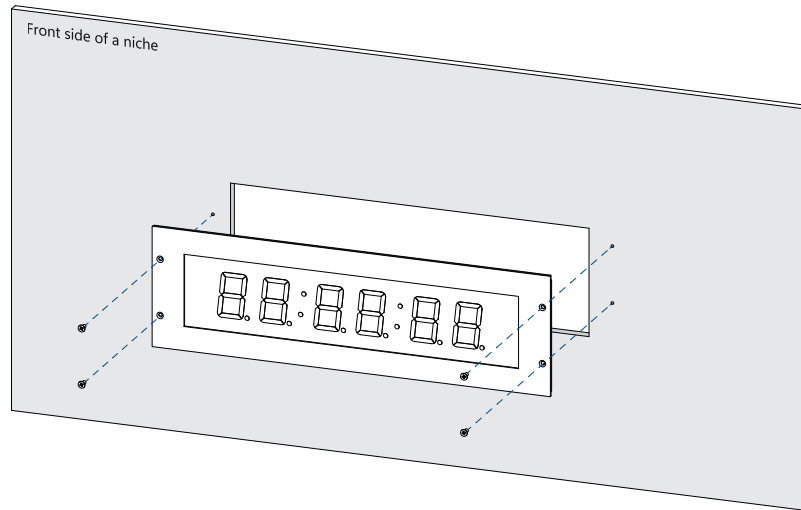

2.1.2. With back cover

1. The clock consists of clock part and back cover. Dismount 4 screws and remove the cover.
2. For wall niche mounting, drill two anchoring holes into a wall of a diameter adequate to accommodate appropriate screws of 4 to 5 mm diameter. As a template for marking the position of holes the back cover can be used.
3. For panel mounting, drill two anchoring holes of 2.6 mm diameter into the panel to accommodate appropriate screws of 4 to 5 mm diameter. As a template for marking the position of the holes the back cover can be used.
4. Pull incoming conductors through the hole in the back side of the cover and fix the cover to a wall / panel using screws.

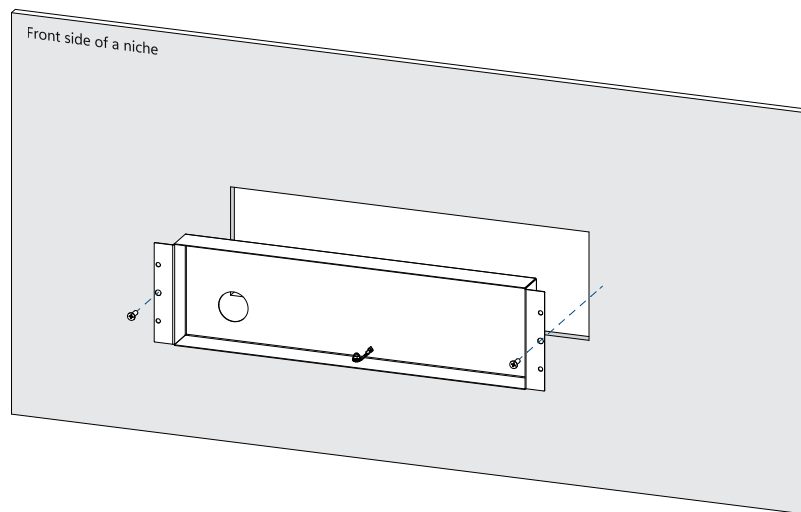

5. On mains powered clock connect the incoming conductors in accordance with the description on the power supply unit using WAGO or equivalent clamps.
6. Mount connectors to cable of synchronization signal line, temperature sensor cable, Ethernet cable or to RS-485 if these are used.



If the clock is synchronized by LGC variant, please navigate to Clock Operation [↗](#) → Non-Network Clock Operation [↗](#) to get detailed info about connection of various synchronization sources and receivers.

For LGC variant, check and configure the position of DIP switch according to used synchronization signal (applies only for DCF, MOBALine, polarized impulse line or IRIG-B).

7. Push the synchronization line connector, the temperature sensor connector, the keyboard connector, Ethernet connector or the RS-485 jacks into the corresponding terminals on the control PCB.



Be careful not to swap terminals. Check the markings of the jack-plugs.

- Put the clock into prepared hole. Check if any cables is not pinched between the clock body and back cover.

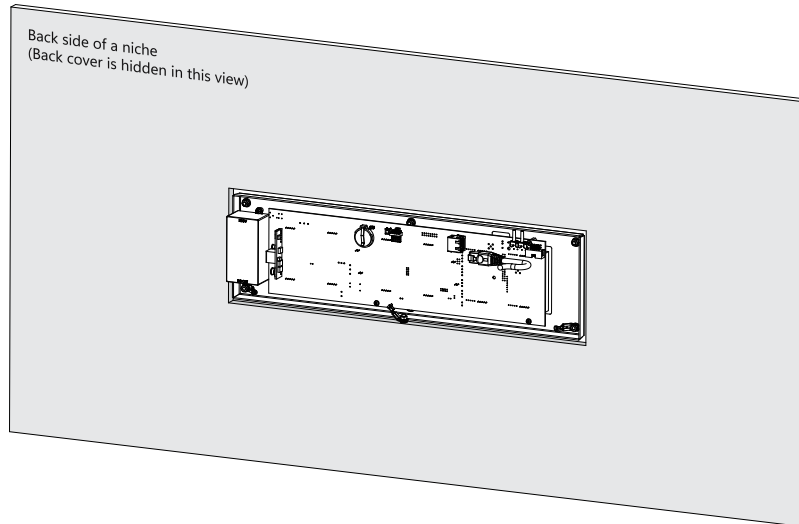

- Fix the clock by four delivered screws to back cover.

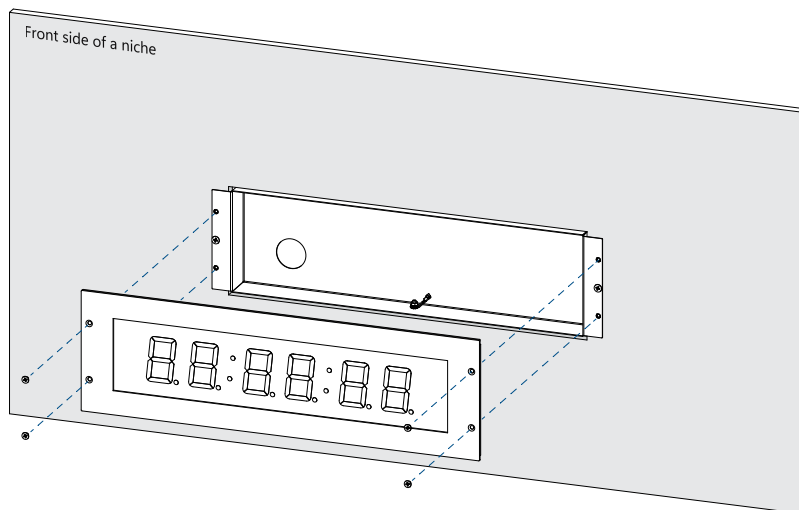

2.2. Cable Connection

2.2.1. Control Board

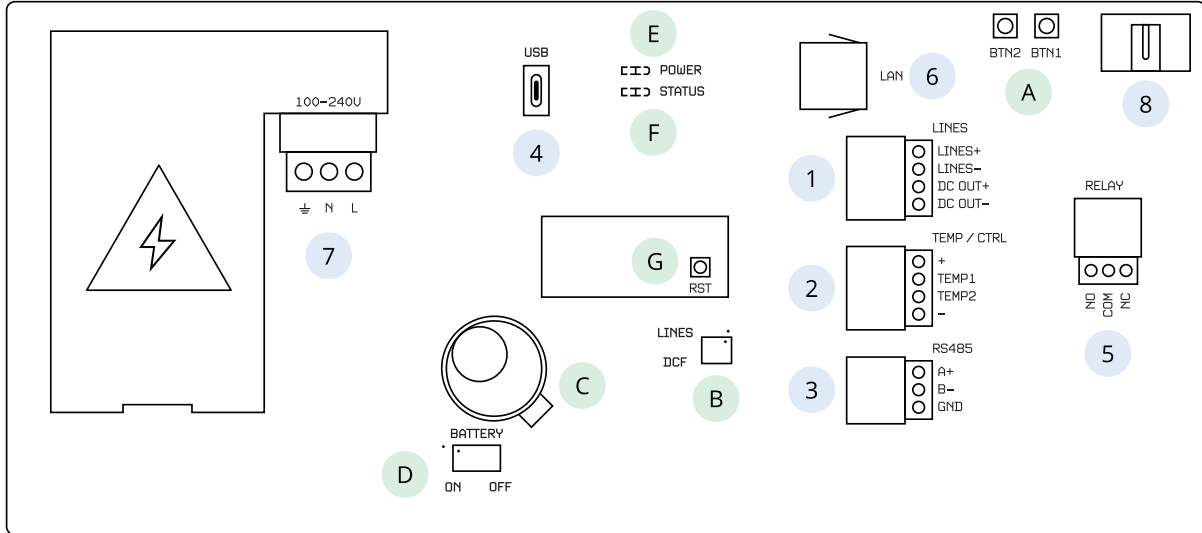

Description

| | | | |
|---|--|---|--|
| 1 | LINES / DC OUT connector (only for LGC variant) | A | Push-buttons PB1, PB2 |
| 2 | TEMP connector | B | DIP switch (only for LGC variant) |
| 3 | RS 485 connector (only with RS 485 option) | C | Battery (BAT option) |
| 4 | USB connector (only for LGC variant and GPS option) | D | Connecting / disconnecting the backup battery (BAT option) |
| 5 | RELAY connector (only for option REL / REL-IP) | E | Powering LED indication |
| 6 | LAN connector (only for PoE and NTP variant) | F | State LED |
| |  Only non-conductive RJ45 connectors can be used. | G | RESET button |
| 7 | POWER (except PoE variant) | | |
| 8 | DISP2 – connection for second side | | |

2.2.2. Connecting Terminal Block



Not for PoE variant

Standard Connection

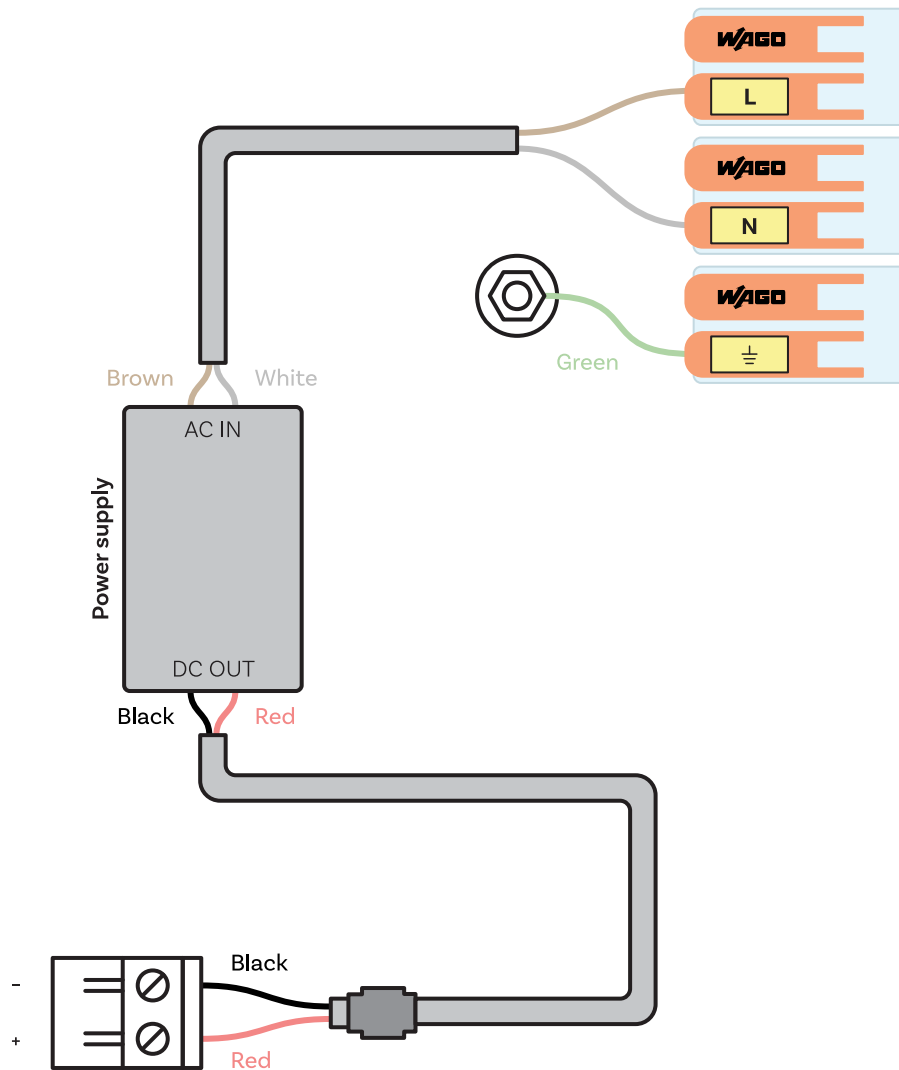

For VDC or RP Option

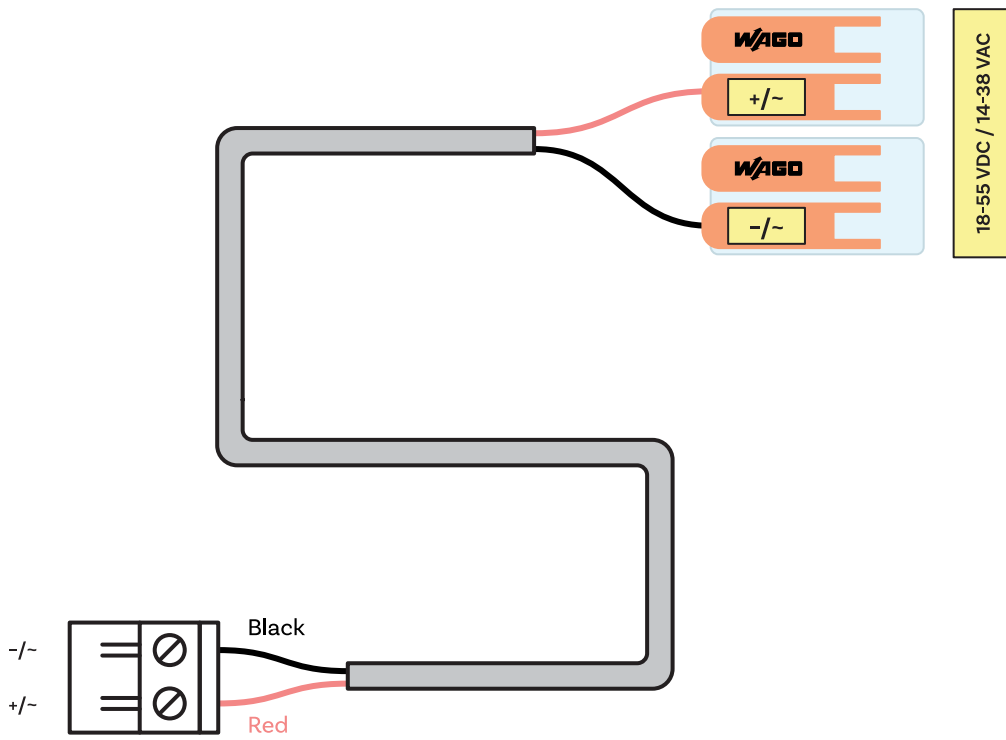

For VDISP Option

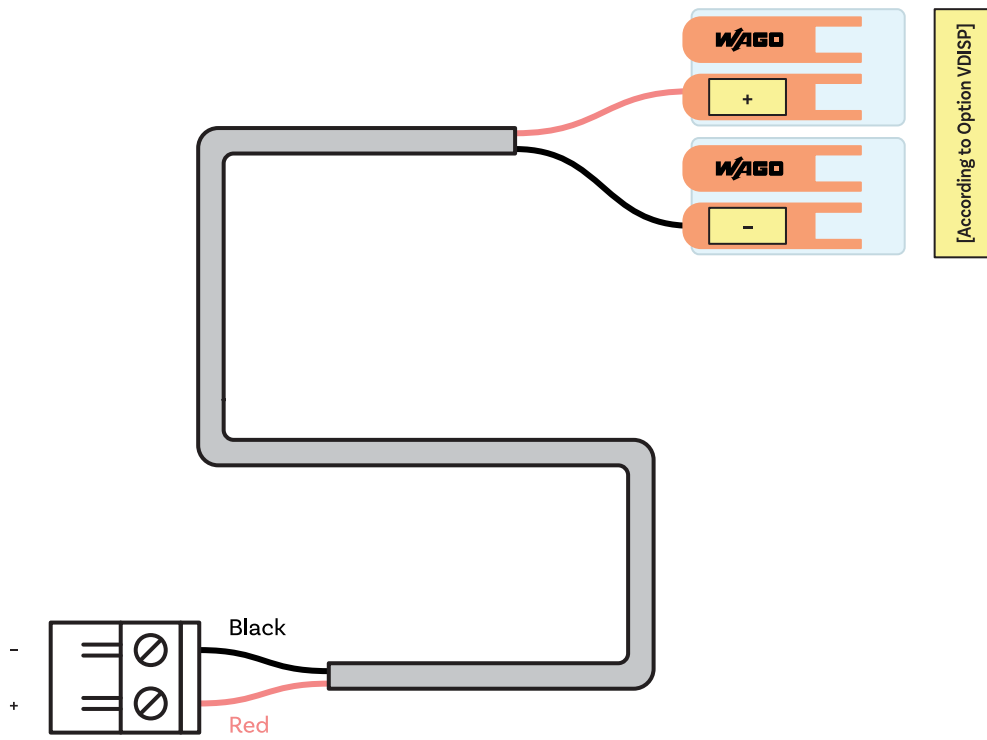

2.2.3. Cable Connection

LINES / DC OUT Wire Connection

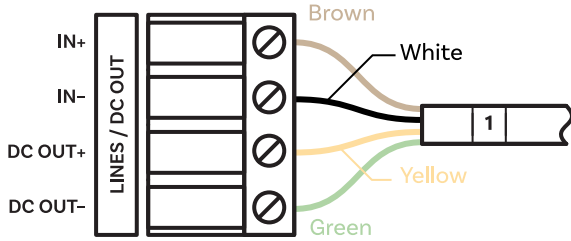

TEMP Wire Connection

One or two temperature sensors

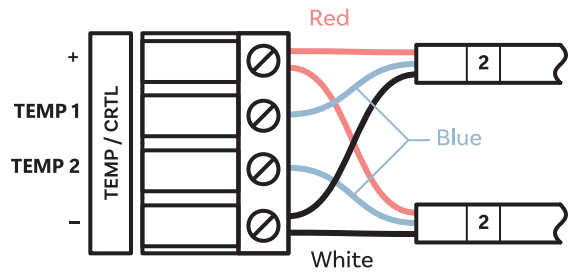
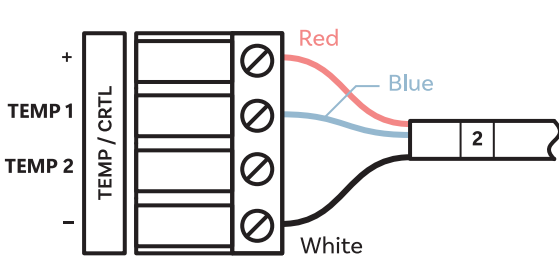

CTRL Wire Connection

Stopwatch control connects to TEMP connector

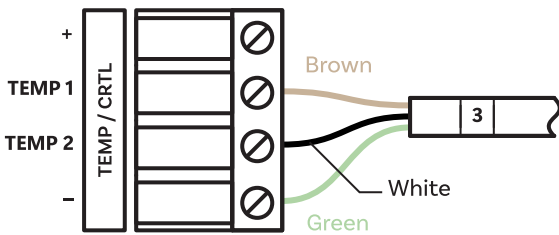

RS-485 Wire Connection

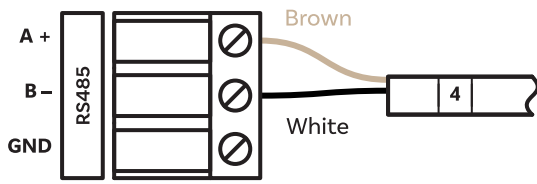

RELAY Wire Connection

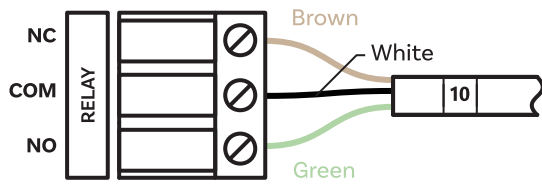

DC IN Connection

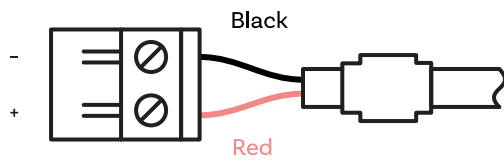

VDC or RP Option Wire Connection

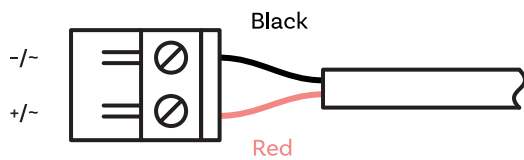

VDISP Option Wire Connection

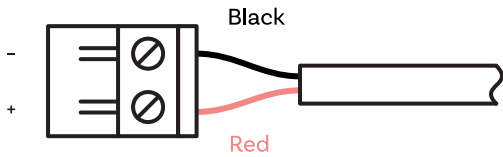

3 Clock Operation

These chapters give you detailed description of different clock operation modes.

- **Non-Network Clock Operation**
For digital clock synchronized by LGC, GPS variant or digital clock with RS-485 option.
- **Network Clock Operation**
For digital clock synchronized by NTP, PoE, PoE+, WiFi or WiFi5 variant.

3.1. Non-network Clock Operation

Depending on the synchronization source, it is necessary to configure the DIP switch on clock PCB - either to the DCF position or to the LINES position (default setting). The position of DIP switch is shown under letter **B** on PCB diagrams.



The correct position of the DIP switch must be set before connecting the line wiring to the LINES connector or before starting the synchronization line.

Enter the **S Y N C** menu item **0 2** (Type of Synchronization) and set the desired type. The Auto-Detection Mode (**0 2: A**) is applicable for DCF signal, MOBATIME serial code, IRIG-B.

The permanently lit colon during the time display signalizes the clock is synchronized by the synchronization source.

3.1.1. DCF 77 Receiver

1. Configure the DIP switch to DCF position.

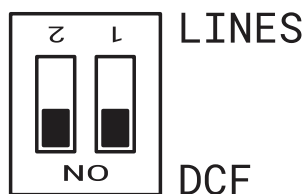

It is important to switch both positions to **ON** (DCF).

2. Set following items:
 - In the **S Y N C** menu, set item **0 1** to value **A** (see Timezone of Synchronization Source chapter)
 - In the **S Y N C** menu, set item **0 2** to value **A** (see Type of Synchronization chapter)
 - In the **d I S P** menu, set item **d 2** to value **A** (see Timezone of Time and Date chapter)
3. Connect the DCF 77 receiver to the clock terminal board placed on the anchoring plate (LINE IN terminals) using a twin-wire cable.

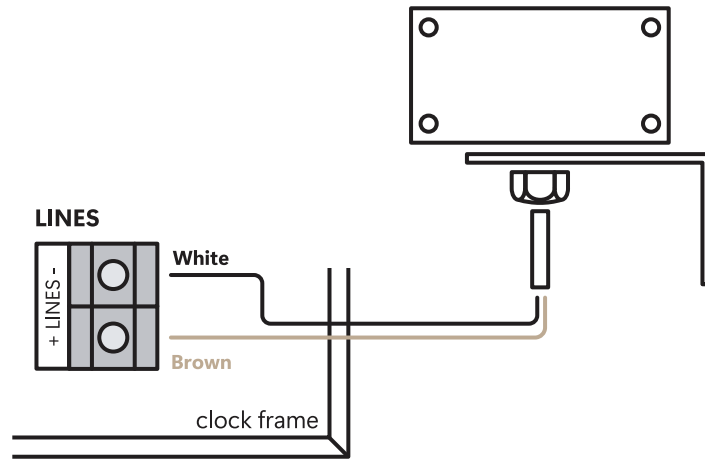

In case of issues with receiving the DCF signal when using the AD 650 / DCF 4500 receiver, it is necessary to ground (connect to PE) one of the signals/inputs (LINES+ or LINES-).

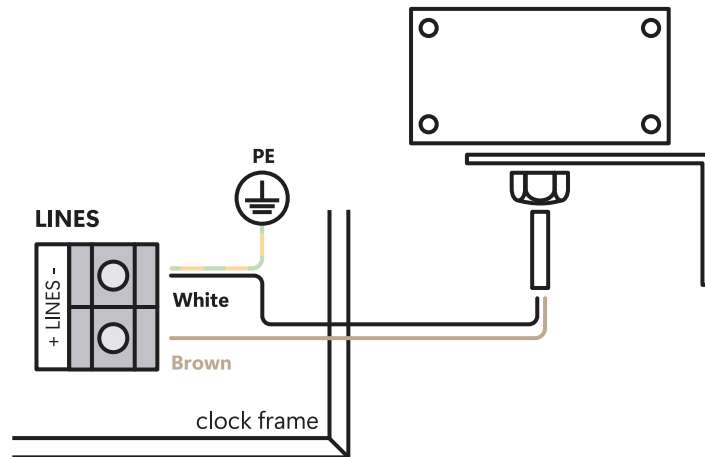

4. The maximum wire length depends on its diameter (approx. 100–300 m at 0.25 mm²).
5. In case the connection is correct and the input signal is at high level, the LED on the receiver is flashing periodically once a second with one pulse left out at the 59th second.



If the polarity is incorrect, the LED does not flash. In such case, interchange the two wires.

6. Install the receiver at a place with a high-level radio signal. Do not install the receiver near sources of interfering signals, such as personal computers, TV sets or other types of power consumers (the digital clock itself generates interfering signals too).
7. Position the receiver with its transparent cover (DCF 450) or the arrow on the cover (DCF 4500) facing the transmitter (located in Frankfurt, Germany). Presuming the good quality DCF 77 signal the synchronization takes place in approx. 3 to 4 minutes. In case of poor quality of the signal (mainly during the day time), the first time setting is to be done manually. The red LED of the receiver displays a working connection by flashing once a second without flickering.

3.1.2. GPS Receiver

1. Set following items:
 - In the **S Y N C** menu, set item **o 1** to value **A** (see Timezone of Synchronization Source chapter)
 - In the **S Y N C** menu, set item **o 2** to value **A** (see Type of Synchronization chapter)
 - In the **d I S P** menu, set item **d 2** to your desired time zone (see Timezone of Time and Date chapter)

2. Connect the GPS antenna to SMA connector.

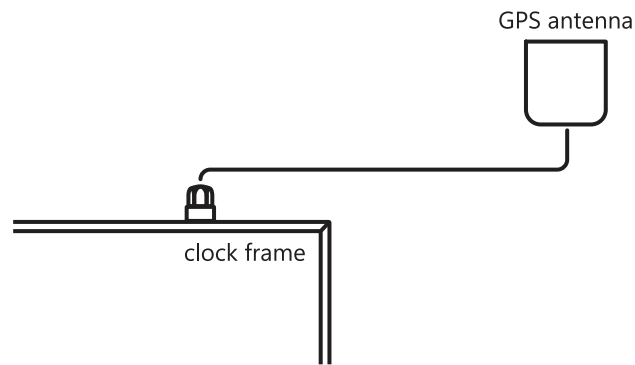

3. Presuming the good position of the GPS receiver the synchronization takes place in approx. 10 to 20 minutes.

3.1.3. GPS Receiver (GNSS 4500)

1. Configure the DIP switch to DCF position.

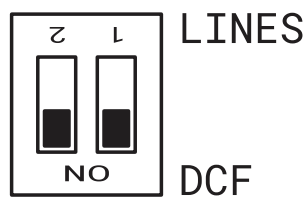

It is important to switch both positions to **ON** (DCF).

2. Set following items:
 - In the **S Y N C** menu, set item **o 1** to value **A** (see Timezone of Synchronization Source chapter)
 - In the **S Y N C** menu, set item **o 2** to value **A** (see Type of Synchronization chapter)
 - In the **d I S P** menu, set item **d 2** to your desired time zone (see Timezone of Time and Date chapter)
3. Connect GPS receiver (GNSS 4500) to the clock terminal board placed on the anchoring plate (LINE IN and DC OUT terminals) using four-wire cable.



Please note the correct polarity of the wires – see the GPS user manual.

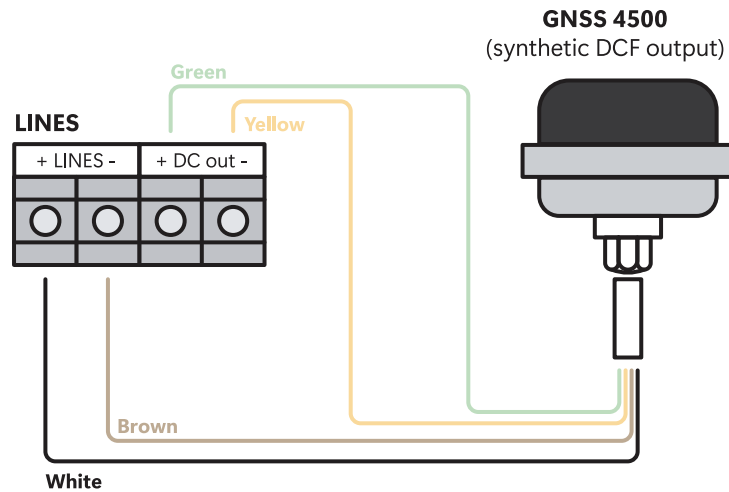

4. For the correct placing of the receiver please follow the GPS user manual.
5. Presuming the good position of the GPS receiver (GNSS 4500) the synchronization takes place in approx. 10 to 20 minutes. The green LED diode lights up.

3.1.4. Synchronizing Impulses

In a time distribution system, where the digital clocks are controlled by polarized impulses, set the **S Y N C** menu item **0 2** to according type of the impulse line (one minute, half minute, second pulses).

1. Configure the DIP switch to LINES position (default setting).

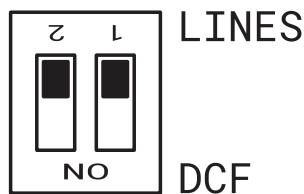

2. Set following items:
 - In the **S Y N C** menu, set item **0 1** to value **A** (see Timezone of Synchronization Source chapter)
 - In the **S Y N C** menu, set item **0 2** to value **A** (see Type of Synchronization chapter)
 - In the **d I S P** menu, set item **d 2** to your desired time zone (see Timezone of Time and Date chapter)
3. The clock time-base is synchronized by incoming pulses in normal operation of the slave line.
4. Set current date and time in the **t I M E** menu according to **MASTER** clock with accuracy of ± 30 seconds (or ± 15 seconds, or ± 0.5 second respectively).
5. The colon flashes in 2 second interval.
6. After 2–3 minutes are the clocks synchronized with the **MASTER** clock. The colon is permanently lit during the display of time.
7. In case of the line fault, the clock displays the right time information based on its own quartz time base. When the normal operation of the line resumes, the clock synchronizes with the incoming pulses.

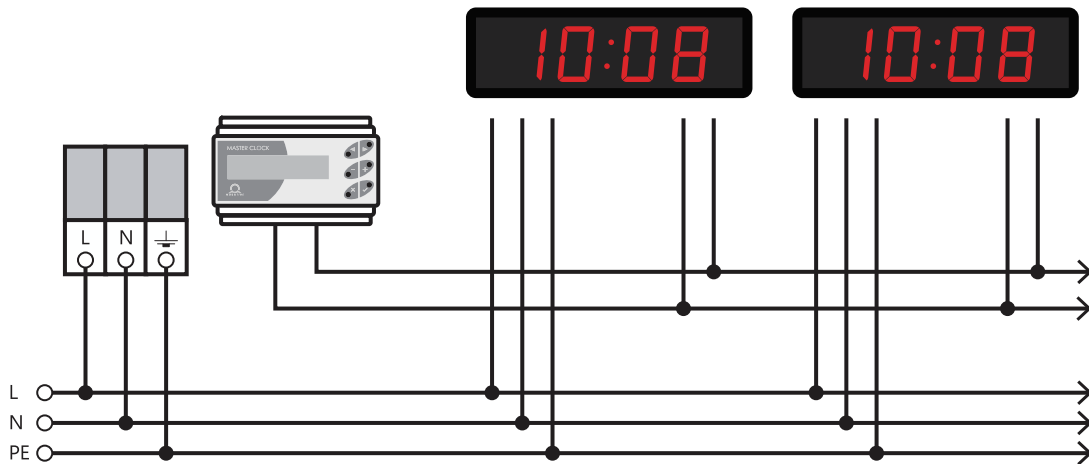

3.1.5. MOBATIME Serial Code, MOBALine or IRIG-B

1. Configure the DIP switch to LINES position (default setting).

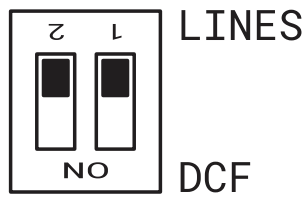

2. After connection of the digital clock to the signal source, time and date are adjusted automatically, following the receipt of valid time information.
3. The time setting with using the serial coded line takes place within at least 5 to 6 minutes, for MOBALine and IRIG-B within 6 to 15 seconds.



See also LINES Input Voltage Range for Control Signals chapter.

3.1.6. IF482 Control over RS-485



Only for RS-485 option.

1. After connection of the digital clock to the line, time and date are adjusted automatically, following the receipt of valid time information.
2. Setting the tune takes place within at least 5 minutes.

3.2. Network Clock Operation

Clock supports IPv4 and IPv6 protocols. You can disable individual protocols by setting values in IP mode in network settings. Default clock setting allows both protocols at the same time – the **NET** menu item **n1** is set to value **0** (see IP Mode chapter).



For IPv4 mode, DHCPv4 is enabled by default – the **NET** menu item **n3** is set to value **1** (see DHCPv4 Mode chapter).

IPv6 mode allows up to 4 different priority IP addresses in downwards order:

- DHCPv6
- manually configured IP address (fix)
- autoconfiguration (SLAAC / RA)
- local address link

For IPv6 mode, DHCPv6 and autoconfiguration (SLAAC) are enabled by default:



DHCPv6 : **NET** menu item **11** is set to value **1** (see DHCPv6 Mode chapter)
SLAAC : **NET** menu item **10** is set to value **1** (see Address Autoconfiguration (SLAAC) chapter)

Default Network Parameters

| Parameter | Value(s) |
|------------------------------------|--|
| IP Mode | IPv4 / IPv6 |
| IPv4 Address | 0.0.0.0 |
| IPv4 Subnet Mask | 0.0.0.0 |
| IPv4 Default Gateway | 0.0.0.0 |
| NTP Server Address 1 | 0.0.0.0 / 0:0:0:0:0:0:0 |
| NTP Server Address 2 | 0.0.0.0 / 0:0:0:0:0:0:0 |
| NTP Server Address 3 | 0.0.0.0 / 0:0:0:0:0:0:0 |
| NTP Server Address 4 | 0.0.0.0 / 0:0:0:0:0:0:0 |
| NTP Request Time [s] | 10 |
| DNS Manager | 0.0.0.0 / 0:0:0:0:0:0:0 |
| SNMP Manager 1 | 0.0.0.0 / 0:0:0:0:0:0:0 |
| SNMP Manager 2 | 0.0.0.0 / 0:0:0:0:0:0:0 |
| Multicast Config Address | 239.192.54.1 / FF38::EFC0:3601 (FF38:239.192.54.1) |
| Alive Notifications Interval [min] | 30 |
| Configuration Port Number | 65532 |
| Timezone Client Port Number | 65534 |
| DHCPv4 | enabled |
| SNMP | enabled |
| Multicast Support | enabled |
| IPv6 Fix Address / Prefix | 0:0:0:0:0:0:0 / 64 |
| IPv6 Link Local Address | fe80 :: 2 [2 nd octet MAC]: [3 rd octet MAC] ff: fe [4 th octet MAC]: [5 th octet MAC] [6 th octet MAC] |
| DHCPv6 | enabled |
| Autoconfiguration (SLAAC) | enabled |
| Web Server | enabled |
| Web Server Password | mobatime |

3.2.1. Unicast Mode

The clock is synchronized to UTC (*Coordinated Universal Time*) from NTP server (up to four IPv4 / IPv6 addresses for NTP server configurable) and **must** have assigned its own IPv4 / IPv6 address. The clock requests in defined intervals the actual time from NTP

server (interval can be adjusted in the **NET** menu item **n 9** (see NTP Polling Interval chapter)). If the server is not available, the clock tries to contact other defined servers in cyclic ways until valid response from NTP server is received.

This operation mode supports monitoring and configuration of movement via network connection by means of **Web Interface** (enabled in the **NET** menu item **15** (see Web Server chapter)), **SNMP** (enabled in the **NET** menu item **14** by setting the value to **1** (see SNMP Protocol chapter)) or **MOBA-NMS Software Tool**.

For supervision and configuration with MOBA-NMS, either clock's IPv4 / IPv6 address can be used or multicast group address (the **NET** menu item **n 7** (see Multicast Address chapter)) must have last octet cleared to zero (presuming that the multicast is not disabled – **NET** menu item **13** is **not** set to value **0** (see Multicast Mode for Configuration of Digital Clock chapter)).

It is necessary to set appropriate timezone for correct displaying of local time and date. More details can be found in:



- Local time calculation according to internal timezone table
- Local time calculation using time zone server MOBATIME
- Local time calculation using time zone entries preconfigured by MOBA-NMS software

3.2.2. Multicast Mode

The clock is synchronized to UTC (Coordinated Universal Time) from NTP server. The clock receives NTP multicast packets transmitted by NTP server in specified time cycle. This type of synchronization requires no clock's own IP address and is therefore suitable for easy commissioning of large systems of **SLAVE** clocks. Further this mode supports monitoring and parameter configuration by means of MOBA-NMS software.

For supervision and configuration with MOBA-NMS, either multicast group address can be used or multicast group address having last octet cleared to zero.

It is necessary to set appropriate timezone for correct displaying of local time and date. More details can be found in:



- Local time calculation according to internal timezone table
- Local time calculation using time zone server MOBATIME
- Local time calculation using time zone entries preconfigured by MOBA-NMS software

Default Network Parameters

| Parameter | Value(s) |
|-------------------------------|--------------------------------------|
| IPv4 Multicast Group Address | 239.192.54.1 |
| IPv4 Multicast Config Address | 239.192.54.0 |
| IPv6 Multicast Group Address | FF38::EFC0:3601 (FF38::239.192.54.1) |
| IPv6 Multicast Config Address | FE38::EFC0:3600 (FF38::239.192.54.0) |
| Configuration Port Number | 65532 |
| Timezone Client Port Number | 65534 |



The **NET** menu item **n 2** must be set to value **1** (see Communication Mode chapter).

3.2.3. Network Parameters Assigned by DHCPv4

IP clock mode must be set to IPv4 mode (can be set in the **NET** menu item **n 1** setting the value either to **0** or **1** (see IP Mode chapter)).

The **NET** menu item **n3** **must** be set to value **1** (see DHCPv4 Mode chapter). Network parameters are automatically obtained from a DHCPv4 server.

The following DHCP options will be evaluated automatically:

- [50]** : IP address
- [3]** : gateway address
- [1]** : subnet mask
- [42]** : list of up to four NTP server addresses / time zone address (usually same as NTP server address)
- [6]** : DNS server
- [26]** : MTU
- [60]** : vendor Class ID
- [43] or [223]** : additional options (refer to document BE-800793)



The network administrator must configure DHCPv4 options accordingly. Assigned parameters can be checked in the **NET** menu items **n4** to **n8**.

3.2.4. Manual Settings through Setup Menu



DHCPv4 **must** be disabled – the **NET** menu item **n3** **must** be set to value **0** (see DHCPv4 Mode chapter).

To manually set all clock network parameters, enter the **NET** menu and set following items listed in table below:

| Menu Item | Description |
|-----------|---------------------------------------|
| n4 | Setting of Clock's IP Address |
| n5 | Setting of Subnet Mask |
| n6 | Setting of Default Gateway |
| n7 | Setting of Multicast Group Address |
| n8 | Setting of Unicast NTP Server Address |

3.2.5. Calculation of Link Local Address

fe80 :: 2 [2nd octet MAC]: [3rd octet MAC] ff: fe [4th octet MAC]: [5th octet MAC] [6th octet MAC]



MAC:
00: **16** : **91** : **12** : **34** : **56**
IPv6:
fe80 :: 2 **16** : **91** ff: fe **12** : **34** **56**

3.2.6. Setting Network Parameters over Autoconfiguration (SLAAC)

IP clock mode **must** be set to IPv6 mode (the **NET** menu item **n1** is set to value **0** or **2** (see IP Mode chapter)).

The **NET** menu item **10** **must** be set to value **1** (see Address Autoconfiguration (SLAAC) chapter). Network parameters are automatically retrieved from a DHCPv6 server.

The following SLAAC options can be processed:

| | |
|-------|-------------|
| [3]: | prefix info |
| [5]: | MTU |
| [24]: | route info |
| [25]: | RDNSS |



The network administrator must configure SLAAC options accordingly.

3.2.7. Setting Network Parameters over DHCPv6

IP clock mode **must** be set to IPv6 mode (the `IP` menu item `IP` is set to value `0` or `2` (see IP Mode chapter)).

The `IP` menu item `IP` **must** be set to value `1` (see DHCPv6 Mode chapter). Network parameters are automatically retrieved from a DHCPv6 server.

The following DHCPv6 options can be processed:

| | |
|-------|--|
| [3]: | Identity Association for Non-temporary Addresses (IA_NA) |
| [16]: | vendor class |
| [17]: | vendor options |
| [23]: | DNS servers |
| [24]: | DNS domains |
| [25]: | identify association for prefix delegation |
| [31]: | SNTP servers |



The network administrator must configure DHCPv6 options accordingly.

3.2.8. SNMP

The clock supports SNMP version 1, version 2c and version 3 for reading and setting parameters using SNMP GET and SET commands. Only SNMP v2c is supported for SNMP trap notification.

SNMP support allows the clock to be integrated into the system for monitoring network elements. The clock (SNMP agent) can send alarms or notifications to the SNMP manager. The IP address of the SNMP manager can be set in the clock via DHCP, web interface, SNMP or MOBA-NMS.

The supported SNMP protocol version and other necessary parameters for user authentication and communication encryption can be set in the clock via the web interface, SNMP or MOBA-NMS. The SNMP version can be set in combinations:

- v3, v2c, v1
- v3, v2c
- v3
- v2c, v1

The structure of the supported parameters is defined in the MIB file. You can download the file from: <https://docs.mobatime.cloud/ECO-SLH-DC/snmp>.

In addition, the clock supports the parameters defined by the "system" node in the MIB-2 definition (RFC-1213). Alarm notifications are asynchronous messages and are intended to inform the SNMP manager about the occurrence or disappearance of an alarm. Alive notifications are sent periodically to inform about availability and clock status. The sending interval can be set.

Alarm notifications are asynchronous messages and are intended to inform the SNMP manager about the occurrence or disappearance of an alarm.

3.2.8.1. Default SNMPv2c Community Strings

| Type of Community | Default Value |
|--------------------------------|---------------|
| Read Community | romobatime |
| Read / Write Community | rwmobatime |
| Notifications (Trap) Community | trapmobatime |

3.2.8.2. SNMPv3

SNMPv3 includes user authentication and communication encryption. Security is provided using a Security name, Authentication password, and Privacy password. During authorization, communication can be encrypted using MD5 or SHA (SHA-1), and the actual communication can be encrypted using DES or AES (AES 128). The security level can be configured.

The clock allows you to set up two user profiles with different access rights within SNMPv3. Each user has their own combination of Security name, Authentication password and Privacy password along with the appropriate encryption and access rights, which together form a profile.

Default parameters for SNMPv3 USM Profile 1

| Parameter | Value |
|-------------------------|-------------------------|
| Security Name | admin |
| Security Level | authentication, privacy |
| Authentication Protocol | SHA |
| Authentication Password | rwmobatime |
| Privacy Protocol | AES |
| Privacy Password | rwmobatime |
| Access Control | read & write |

Default Parameters for SNMPv3 USM Profile 2

| Parameter | Value |
|-------------------------|-------------------------|
| Security Name | user |
| Security Level | authentication, privacy |
| Authentication Protocol | SHA |
| Authentication Password | romobatime |
| Privacy Protocol | AES |
| Privacy Password | romobatime |
| Access Control | read only |

3.2.8.3. Web Interface

Overview

Network

Time

Time zone

Mode

Sensors

Supervision

General

Command

Authentication

Manual

Logout

Supervision

English ▾

SNMP

Notification manager 1

Notification manager 2

Alive notification send interval min

Enabled versions

SNMPv2c parameters

Read community string

Write community string

Trap community string

SNMPv3 USM Profile 1

Security name

Security level

Authentication protocol

Authentication password

Privacy protocol

Privacy password

Access control

SNMPv3 USM Profile 2

Security name

Security level

Authentication protocol

3.2.9. HTTPS

The web interface of the digital clock is accessible from a web browser via HTTP and HTTPS protocols. The clock is supplied with a pre-made certificate for secure communication via HTTPS protocol. The certificate is not backed by a certificate authority, so the web browser will display a warning that the connection is not private. In this case, you need to accept this condition and continue on to the website.



Certificates are provided in the manufacturer process since firmware version r7.15. In case of firmware update from earlier version, you need to upload SSL certificate by your own.

The default password for the web interface is *mobatime*. The password can be changed via the web interface, MOBA-NMS and SNMP. You can also use mDNS on your local network. You can use the hostname of the digital clock and use it with the .local extension instead of the IP address. The hostname is composed of the word MOBATIME and the last 3 octets of the MAC address.

| | | |
|---|-------------------------------|---|
|  | MAC address : | 00:16:91:12:34:56 |
| | ↓ | |
| | Hostname : | MOBATIME123456 |
| | Enter to address bar : | http://mobatime123456.local or https://mobatime123456.local |

The web interface mode can be set in the web interface – Supervision tab. Combinations can be set:

- HTTP and HTTPS
- HTTP only
- HTTPS only
- HTTP redirect to HTTPS

User certificates can be uploaded to the clock using the tftp protocol. The certificate files need to be named:

- **key.pem** : private key
- **cert.pem** : certificate
- **ca.pem** : certificate of certification authority

To upload files, use the HTTPS server certificate upload option to select each file type in turn. Press the Apply button to start the upload.

To apply user certificates, under HTTPS server certificate manage, select *Apply user certificates*, and then click **Apply**.

To delete user certificates, set this entry to *Apply factory certificates (delete user certificates)* and confirm with **Apply**. After the clock restarts, the new certificate will be used.

3.2.10. WiFi Operation Modes



Available only for WiFi or WiFi5 variant.

WiFi Operation Modes can be set in the **NET** menu item **12** (see WiFi Mode chapter).

3.2.10.1. Station Mode (User Defined)

- Connecting to a user-defined WiFi network.
- The WiFi network is defined via MOBA-NMS software tool or Web Interface.

3.2.10.2. Station Mode (MOBA-WIFI)

- Connecting to WiFi with SSID **MOBA-WIFI**.
- Uses WPA2-PSK encryption with default password **hgfedcba**.
- Other network parameters are set according to current settings.

3.2.10.3. AP Mode

- Creates a WiFi AP (Access Point) on 2.4 GHz with SSID **MOBAxxxxxxxxxx** where **xxxxxxxxxx** is MAC address of specific clock.
- Default encryption WPA2-PSK with default password **password**.
- Active internal DHCP server, **192.168.2.0** network with an allocated range of **.100** to **.254**.
- Clock are accessible at static address **192.168.2.1**.



AP mode will disable DHCP on the clock and the clock will operate on static IP address. When switching back to Station mode, manually re-enable DHCP if required or reconfigure static IP address.

- Configuration via web interace only (due to password entry).





4 Settings

These chapters provide instruction and information on how to configure and customize various features and settings of the digital clock. It helps users set up the clock according to their preferences and needs.

4.1. Control

The clock is set and controlled by two push-buttons or by remote controller. Position of push-buttons depends on the clock type. Push-buttons are mostly located on the upper side of the frame.







4.1.1. Push-buttons

| Button | Description | Function |
|--|-----------------------------|---|
|  | Push-button 1 (short press) | <ul style="list-style-type: none"> Moving "up" in menu / submenu Decreasing of set value |
|  | Push-button 1 (long press) | <ul style="list-style-type: none"> Exit from menu / submenu / set value Exit without saving |
|  | Push-button 2 (short press) | <ul style="list-style-type: none"> Moving "down" in menu / submenu Increasing of set value |
|  | Push-button 2 (long press) | <ul style="list-style-type: none"> Entry into menu submenu / set value Save and exit |
|  ¹ | Push-button 3 (long press) | <ul style="list-style-type: none"> Entry into stopwatch display |



Long press is activated if the push-button is pressed for longer than 1 second.

4.1.2. Remote Controller Buttons

| Button | Function |
|---|--|
|  | <ul style="list-style-type: none"> Moving "up" in menu / submenu Exit from stopwatch display into main screens |
|  | <ul style="list-style-type: none"> Moving "down" in menu / submenu |
|  | <ul style="list-style-type: none"> Exit from menu / submenu / set value Exit without saving |
|  | <ul style="list-style-type: none"> Entry into menu / submenu / set value Save and exit |
|  | <ul style="list-style-type: none"> Entry into menu from mains screens Entry into menu from stopwatch display |
|  | <ul style="list-style-type: none"> Entry into stopwatch display from main screens |

| Button | Function |
|--------|---|
| CLOCK | • Exit from stopwatch display into clock display |
| DATE | • Exit from stopwatch display into date / calendar week display |
| TEMP | • Exit from stopwatch display into temperature display |
| - | • Decreasing of set value |
| + | • Increasing of set value |

1 Available only on stopwatch keyboard accessory.

4.2. Navigation scheme

- Control of the clock using push-buttons placed on the clock is marked in blue frame with blue text.
- Control of the clock using the buttons on remote controller buttons is marked in orange frame with orange text.

4.2.1. Navigation using push-buttons



4.2.1.1. Example of dISP submenu setting

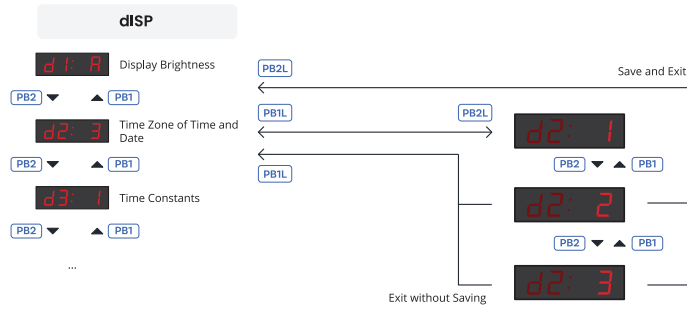

4.2.1.2. Example of NEt submenu setting

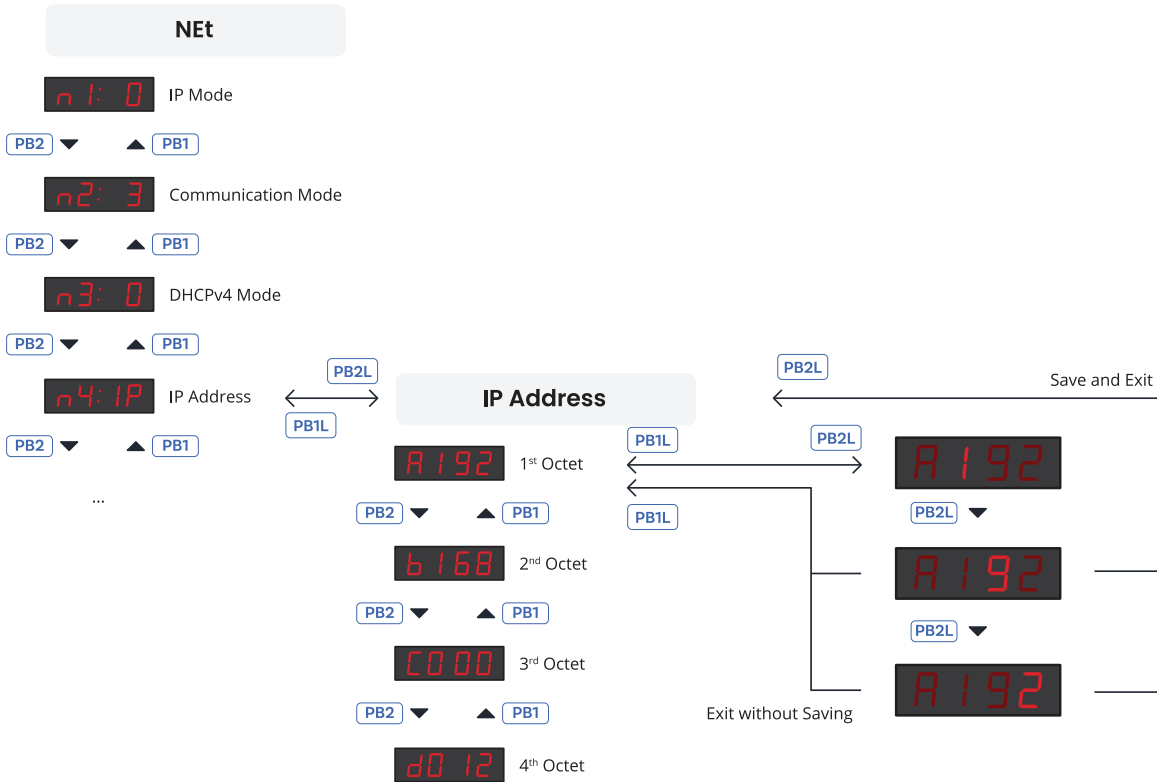

4.2.2. Navigation using remote controller

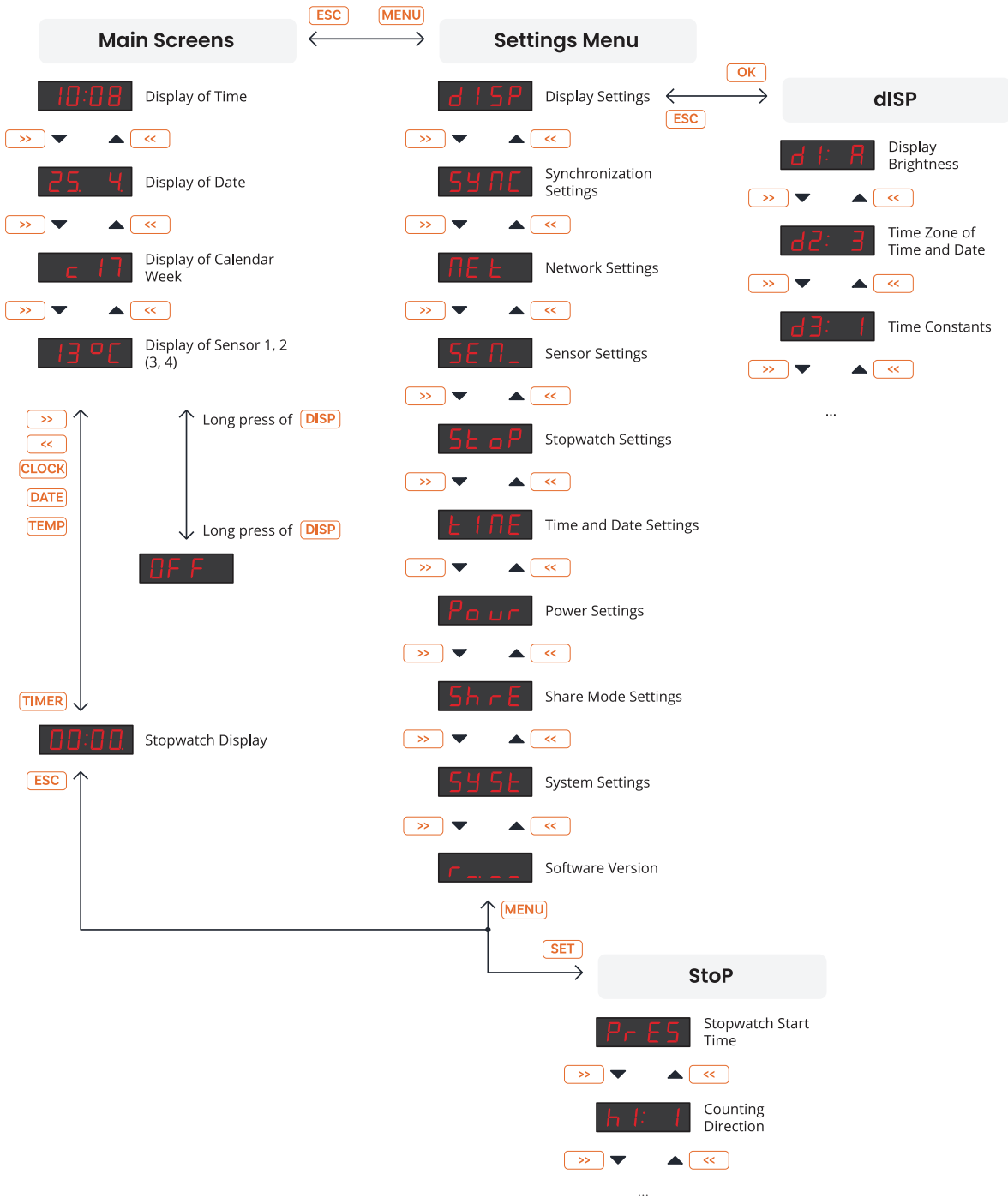

4.2.2.1. Example of dISP submenu setting

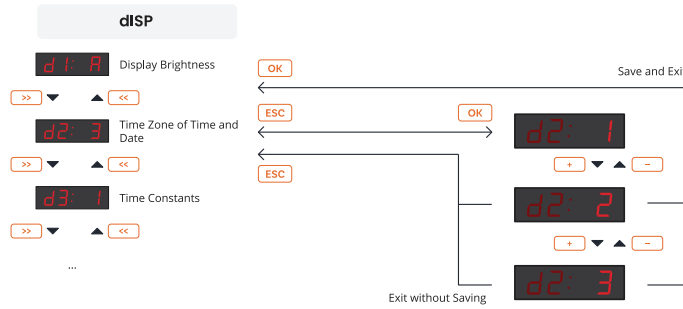

4.2.2.2. Example of NEt submenu setting

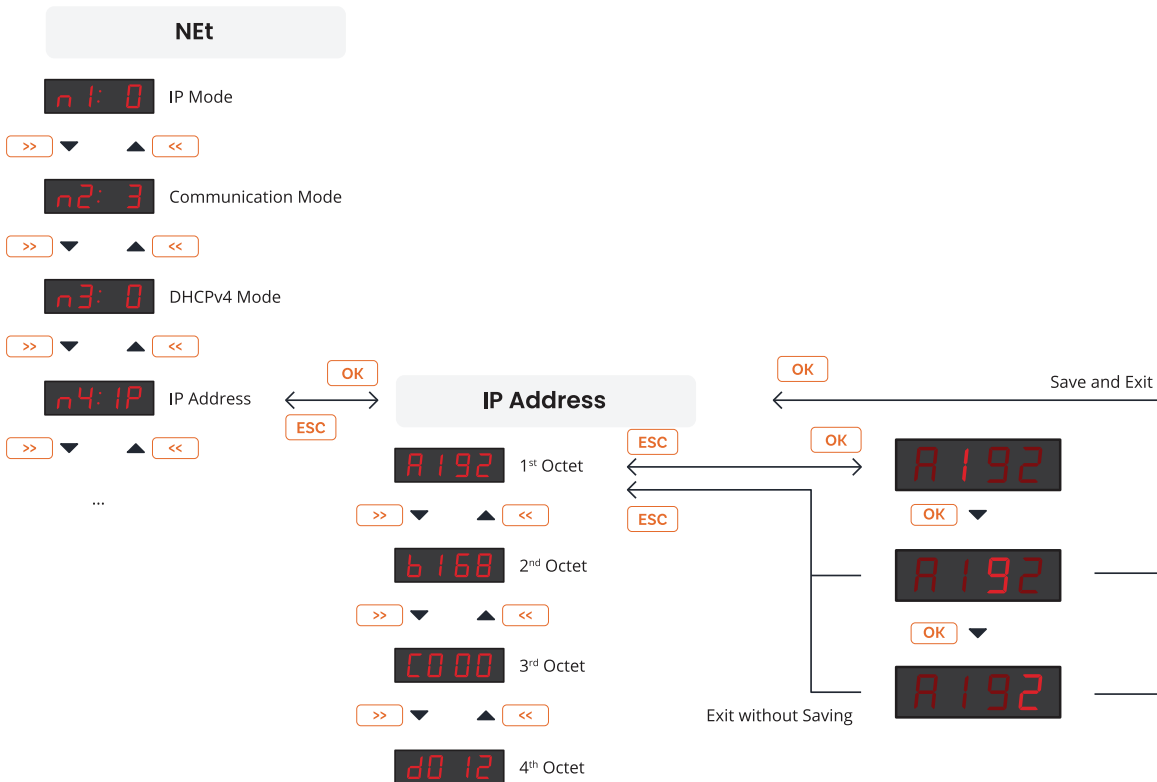

4.3. Web Interface

The web interface for this digital clock configuration tool is designed to provide users with a seamless and customizable experience in setting up their preferred digital timepiece directly within their browser.

4.3.1. How to Access the Web Interface?

To access the web interface of the clock, you first need to know its IP address. Please follow these steps to view the IP address of the clock:

Step 1: Find the IP Address of the Clock

- From main screen (time, date, ...) enter the main menu by pressing the **PB2L** push-button or the **MENU** button on the remote controller.



- Use the navigation buttons (the **PB2** push-button or the **>>** button on the remote controller) to scroll through the main menu until you reach the **NET** menu.



- Enter the **NET** menu by pressing the **PB2L** push-button or the **OK** button on the remote controller.



- Inside the **NET** menu, use navigation buttons to cycle through the items until you reach **n4:IP** item.



- Enter the **n4:IP** item by pressing the **PB2L** push-button or the **OK** button on the remote controller.



- The first octet of clock's IP address is now shown (e.g., **A192**).

Press the **PB2** push-button or the **>>** button on the remote controller to cycle between octets (**b**, **c** and **d**).



Step 2: Access the Web Interface

- On your computer or device, open a web browser (e.g., Chrome, Firefox, Edge).
- Click into the address bar at the top of the browser window (where the website URL usually appears) and type the IP address you obtained from the clock's display.



Make sure to enter the IP address without leading zeros in each octet (e.g., display shows **068** → enter **68**, display shows **000** → enter **0**)!



Press **Enter** on your keyboard.

- The Authentication screen will appear. Enter the default password: **mobatime** , then press **Login** .

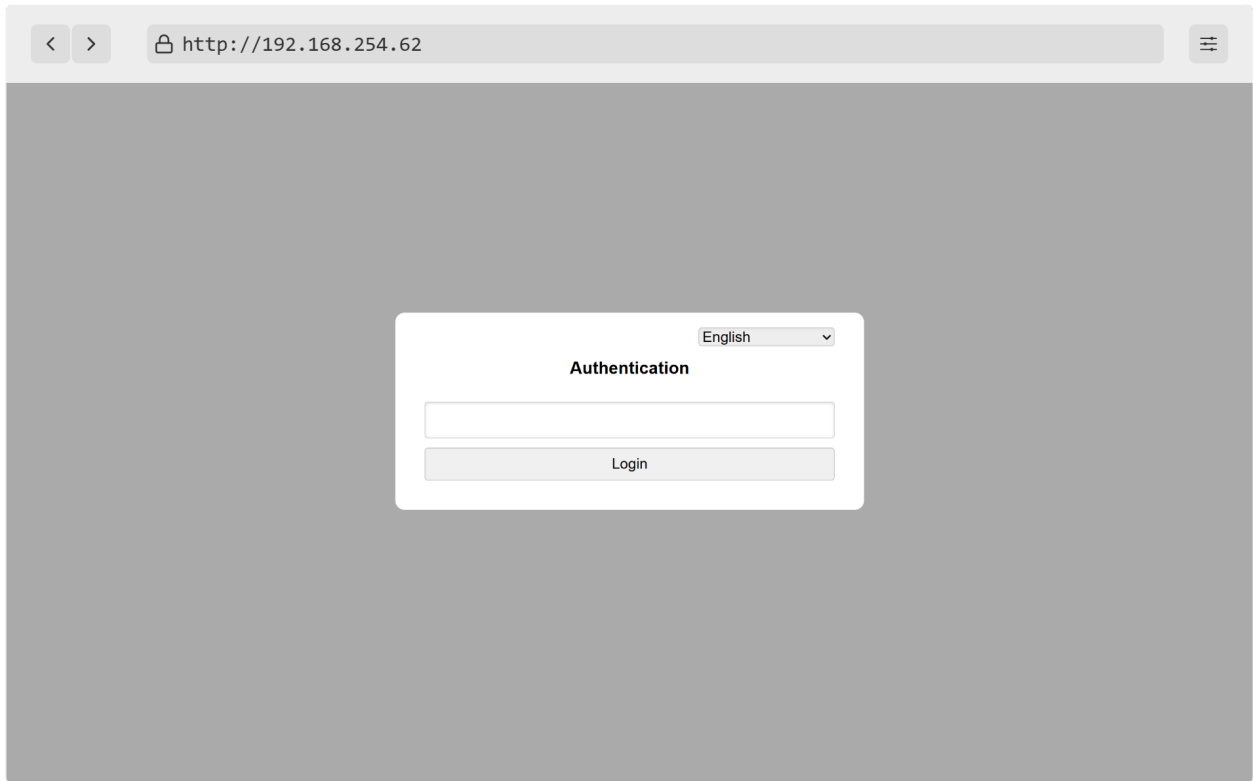

4.3.2. Generate SSL Certificate

For access to the digital clock via secured web pages - https it is necessary to burn SSL certificate directly to the digital clock. Clocks are provided with a factory certificate which is generated during the manufacturer process.



More info about accessing the Web Interface from web browser via HTTP and HTTPS protocols can be found in **Clock Operation > Network Clock Operation > HTTPS Chapter** .

Certificates are provided in the manufacturer process since SW version **v7.12** . In the case of updating SW version in the digital clock from earlier versions, there will be an active alarm **Invalid SSL certificate** . So it is necessary to upload an SSL certificate by your own.

Certificates required:

- RSA 2048 bit
- Fingerprint using SHA-256

4.3.2.1. Generate Certificate

You can use any method to generate certificates.

If you are unfamiliar with the process of certificate generation, you may utilize this website.

1. Visit [CertificateTools.com](https://www.certificate-tools.com) .

CertificateTools.com Revocation Generators

CertificateTools.com X509 Certificate Generator

Use Existing Certificate as a Template Web Server

Private Key

Generate PKCS#8 RSA Private Key 2048 Bit

Encrypt

Subject Attributes

Add / Remove Attributes

Common Names

MOBATIMEFD306F Add

Add a common name

Country CZ

State South Moravian

Locality Vyškov

Organization Acme Inc.

Subject Alternative Names

DNS MOBATIMEFD306F Add

Add a subject alternative name

x509v3 Extensions

OCSP Must-Staple

Key Usage

Extended Key Usage

Basic Constraints (CA)

Encoding Options

Default

CSR Options

SHA256 30 Year(s) Self-Sign

Submit

- On the top right list please select option **Web Server** (marked by blue).
- To the columns **Common Names** (marked by red), please type requested name of the subject and click **Add** .
 - For example `MOBATIMEFD306F` is used for the MAC address `00:16:91:fd:30:6f` in the manufacturer process.
- To the column **Subject Alternative Names** → **DNS** (marked by yellow), please type requested name of the subject and then click **Add** .

The requested name of the subject can be:

- `MOBATIMEFD306F` (as stated above)
 - `MOBATIMEFD306F.local`
 - IP address
- In the CSR Options please set CSR Only to the **Self-Sign** (marked by purple) and type requested validity of certificate, e.g. 30 years.
 - Optionally, you can also set other fields.
 - Then click **Submit** .
 - The web page will generate a certificate.
 - Download files **Private Key** and **PEM Certificate** .

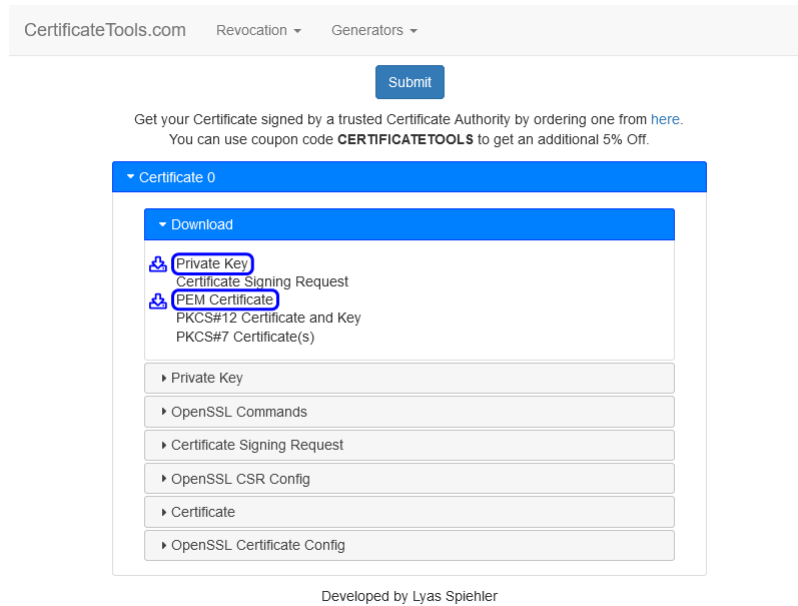

You can also use these instructions if you want to generate different SSL certificates.

4.3.2.2. Uploading a Certificate

1. Rename file `cert.key` (Private Key) to `key.pem` .
2. Rename file `cert.crt` (PEM Certificate) to `cert.pem` .
3. Copy these files to the folder for your TFTP server.
4. On the web page of digital clock navigate to section **Supervision** → **Services** .
5. Set the field **HTTPS server certificate upload** to **Private Key** and press **Apply** .
It should display `Configuration saved` and the Private Key should be uploaded.
6. Set the field **HTTPS server certificate upload** to the **Certificate** and press **Apply** .
It should display `Configuration saved` and the Certificate should be uploaded.

4.3.2.3. Certificate Application and Managing

Apply a New Certificate

1. Set the field **HTTPS server certificate manage** to the **Apply user certificates** and press **Apply** .
It should display `Configuration saved` and a new certificate should be uploaded.

Delete User Certificate

1. Set the field **HTTPS server certificate manage** to the **Apply factory certificates (delete user certificates)** and press **Apply** .
It should display `Configuration saved` and user certificates should be deleted.

4.3.3. Overview Tab

This is the front page of web interface. Here you can see system basic system information such as Device type, description, Firmware version, Time, MAC and IPv4 address.

Nothing at this tab cannot be edited.

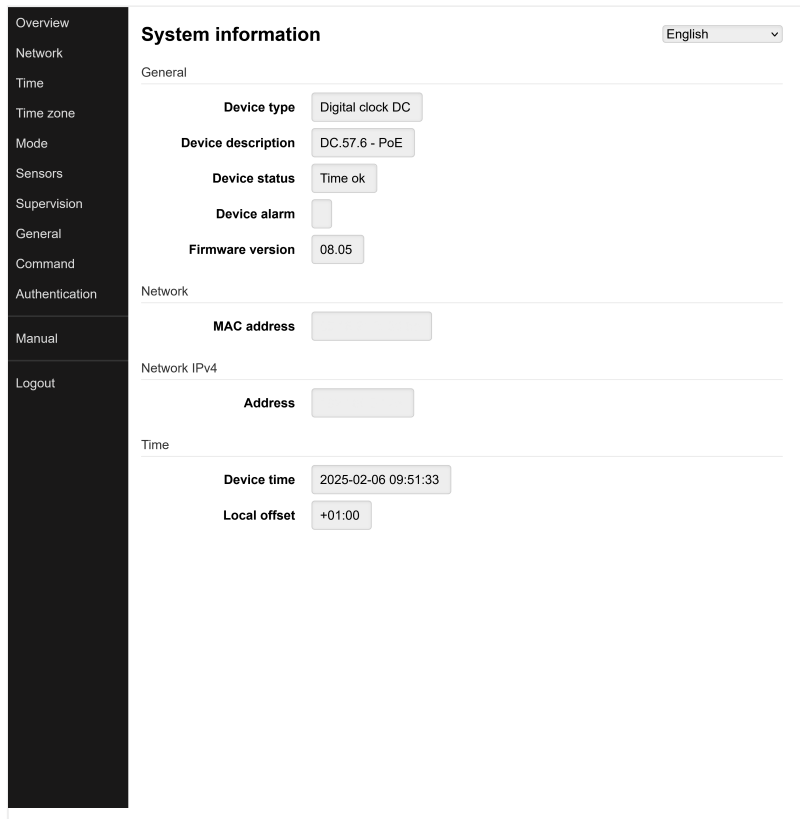

System information English

General

Device type Digital clock DC

Device description DC.57.6 - PoE

Device status Time ok

Device alarm

Firmware version 08.05

Network

MAC address

Network IPv4

Address

Time

Device time 2025-02-06 09:51:33

Local offset +01:00

4.3.4. Network Tab

This tab serves as network setting of clock parameters. You can almost set any network-related settings, such as IP mode, multicast enable or disable, IPv4 and IPv6 address, even Timezone client port.

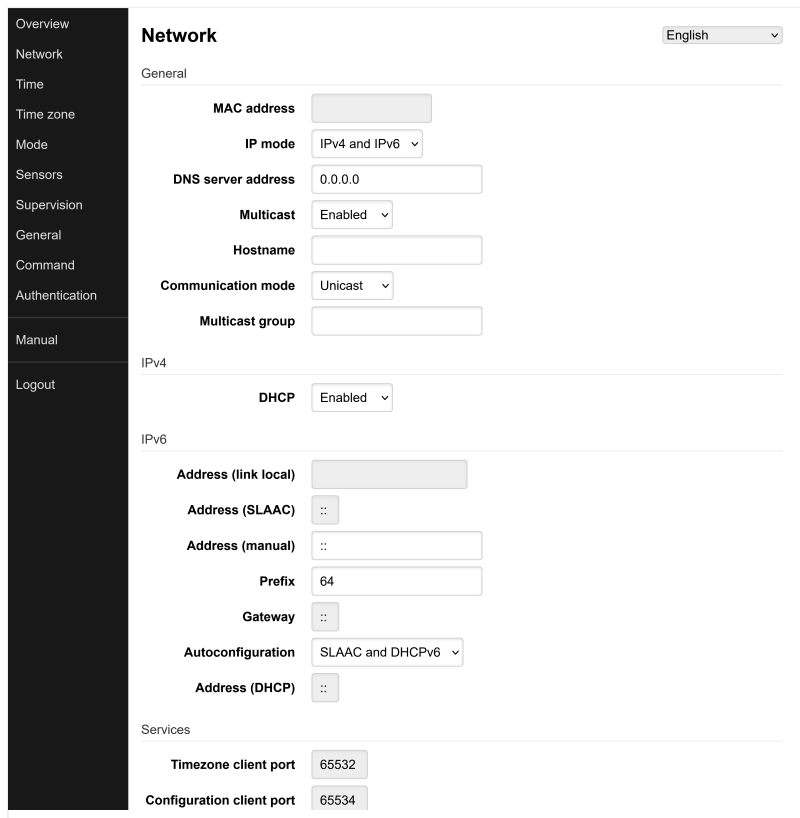

Network English

General

MAC address

IP mode IPv4 and IPv6

DNS server address 0.0.0.0

Multicast Enabled

Hostname

Communication mode Unicast

Multicast group

IPv4

DHCP Enabled

IPv6

Address (link local)

Address (SLAAC) ::

Address (manual)

Prefix 64

Gateway ::

Autoconfiguration SLAAC and DHCPv6

Address (DHCP) ::

Services

Timezone client port 65532

Configuration client port 65534

4.3.5. Time Tab

Time English

General

Current NTP server

Device time 2025-02-06 09:53:58

Local offset +01:00

Last sync 2025-02-06 09:53:53

Timeout to indicate no sync 24 h

NTP

Server address 1

Server address 2

Server address 3

Server address 4

Poll interval 10 s

Apply

4.3.6. Time Zone Tab

Time zone English

General

Entry selection 2

Apply

4.3.7. Mode Tab

- Overview
- Network
- Time
- Time zone
- Mode
- Sensors
- Supervision
- General
- Command
- Authentication
- Manual
- Logout

English ▼

Mode

General

Display brightness Auto ▼

IR auto lock time U ▼

Display current derating no derating ▼

Light measurement correction 50% ▼

Stopwatch keyboard connected No ▼

Display 1

Time display format 24 ▼

Display alternating mode User defined ▼

Time display zeros Yes ▼

Date display zeros Yes ▼

Display 1 - User intervals of Display alternating mode

Time 6 s ▼

Date 3 s ▼

Calendar week off ▼

Temperature 1 off ▼

Humidity 1 off ▼

Pressure 1 off ▼

Temperature 2 off ▼

Humidity 2 off ▼

Pressure 2 off ▼

4.3.8. Sensors Tab

- Overview
- Network
- Time
- Time zone
- Mode
- Sensors
- Supervision
- General
- Command
- Authentication
- Manual
- Logout

English ▼

Sensors

General

Supported types

TP3/30, TPH 1m, TP LAN, TP LAN PoE, TPHP LAN, TPHP LAN PoE, TP Shared, TPH Shared, TPHB Shared

Sensor 1

Type TP3/30 ▼

1-Wire input TEMP 1 ▼

Sensor 1: Temperature

Correction 0 +10 hP

Display units Enabled ▼

Unit °C ▼

Sensor 2

Type TP3/30 ▼

1-Wire input TEMP 2 ▼

Sensor 2: Temperature

Correction 0 +10 hP

Display units Enabled ▼

Unit °C ▼

Apply

4.3.9. Supervision Tab

Overview
 Network
 Time
 Time zone
 Mode
 Sensors
 Supervision
 General
 Command
 Authentication
 Manual
 Logout

Supervision

English ▾

SNMP

Notification manager 1

Notification manager 2

Alive notification send interval min

Enabled versions v3, v2c, v1 ▾

SNMPv2c parameters

Read community string

Write community string

Trap community string

SNMPv3 USM Profile 1

Security name

Security level Auth, Priv ▾

Authentication protocol SHA (SHA-1) ▾

Authentication password

Privacy protocol AES (AES128) ▾

Privacy password

Access control Read & write ▾

SNMPv3 USM Profile 2

Security name

Security level Auth, Priv ▾

Authentication protocol SHA (SHA-1) ▾

4.3.10. General Tab

Overview
 Network
 Time
 Time zone
 Mode
 Sensors
 Supervision
 General
 Command
 Authentication
 Manual
 Logout

General

English ▾

General

Device type Digital clock DC

Device description

Firmware number

Firmware version 08.05

Device status Time ok

Device alarm

Bootloader number

Bootloader version 03.00

Apply

4.3.11. Command Tab

Overview
Network
Time
Time zone
Mode
Sensors
Supervision
General
Command
Authentication
Manual
Logout

Command English

General

Software reset

Factory reset

Firmware update

Apply

4.3.12. Authentication Tab

Overview
Network
Time
Time zone
Mode
Sensors
Supervision
General
Command
Authentication
Manual
Logout

Authentication English

General

HTTP password

Apply

5 Display Settings

The display shows following:



Enter digital clock's main menu and navigate to **d 1 5 P** submenu. Enter by pressing the **PB2L** push-button or the **OK** button on the remote controller.

Display Settings Summary

| Menu Item | Description | Value(s) |
|-----------|--|------------------------|
| d 1 | Display Brightness | 1 - 30, A * |
| d 2 | Timezone of Time and Date | 0 - 64, A *, U 1 - U 7 |
| d 3 | Time Constants for Automatic Data Switching Over | 1, 2, 3, 4, 5, 6, U, 0 |
| d 4 | 12-Hour Format | 0 *, 1 |
| d 5 | Time with Leading Zero | 0, 1 * |
| d 6 | Date with Leading Zero | 0 *, 1 |
| d 8 | Clock Address for IR Remote Controller (Moved to 5 4 5 E menu since version r 7.15) | 1 - 99 |
| d 9 | IR Remote Controller Auto-Lock (Moved to 5 4 5 E menu since version r 7.15) | 1 - 60, U |
| i 0 | Display of Time (User Defined) | 0 - 60 [s] |
| i 1 | Display of Date (User Defined) | 0 - 60 [s] |
| i 2 | Display of Calendar Week (User Defined) | 0 - 60 [s] |
| i 3 | Display of Temperature 1 (User Defined) | 0 - 60 [s] |
| i 4 | Display of Humidity 1 (User Defined) | 0 - 60 [s] |
| i 5 | Display of Pressure 1 (User Defined) | 0 - 60 [s] |
| i 6 | Display of Temperature 2 (User Defined) | 0 - 60 [s] |
| i 7 | Display of Humidity 2 (User Defined) | 0 - 60 [s] |
| i 8 | Display of Pressure 2 (User Defined) | 0 - 60 [s] |

Default values are indicated with *, e.g., 1 *.

5.1. Display Brightness

Navigation

Menu:

Item:

Available values:

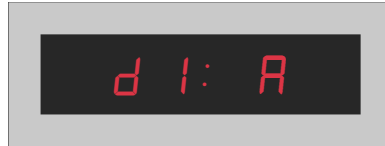
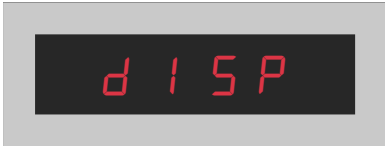

1 - 30, A

Description

Display brightness setting allows you to customize the luminance of the display. Brightness level is defined by numerical values or by sensor controlled automatic adjusting.

Available Settings

| Value(s) | Description |
|-------------------|--|
| 1 - 30 | Lower value = lower brightness, higher value = higher brightness |
| A (default value) | Automatic brightness |



Adjusting the brightness in manual mode to the maximum can reduce the life of displays in the long run. We recommend leaving the automatic brightness control set.

5.2. Timezone of Time and Date

Navigation

Menu:

Item:

Available values:

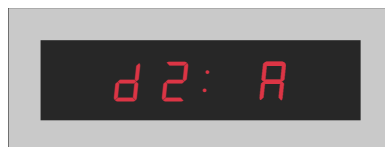
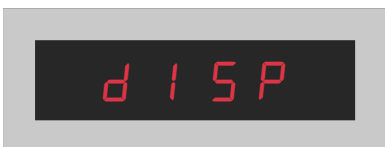

0 - 64, A, U 1 - U 7

Description

Timezone of displayed time and date refers to geographical region or offset from UTC (that is used as a reference point for displaying the current time and date). Timezone is crucial aspect of timekeeping and helps ensure consistency and accuracy in communication, scheduling and record-keeping.

Available Settings

| Value(s) | Description |
|-------------------|---|
| 0 - 64 | Timezone entries, see Timezones Table chapter |
| A (default value) | Automatically set timezone |
| U 1 - U 7 | Preconfigured timezone from MOBA-NMS software |

5.3. Time Constants for Automatic Data Switching Over

Navigation

Menu:

Item:

Available values:

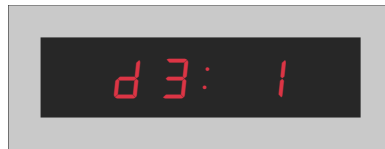
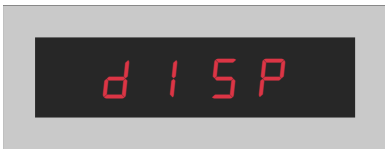

1, 2, 3, 4, 5, 6, U, 8, 0

Description

This settings allows to choose the displayed data together with or without automatic switching over to next data. The time sequence of corresponding figures can be user-defined or predefined time sequence can be used.

Available Settings

| Value(s) | Description |
|-------------------|--|
| 1 (default value) | Continuous display of time |
| 2 | Continuous display of date |
| 3 | Continuous display of temperature |
| 4 | Continuous display of stopwatch |
| 5 | Display sequence: time 6 s, date 3 s |
| 6 | Display sequence: time 8 s, date 3 s, temperature 3 s |
| U | Time constants set up by user in seconds for each specific displayed data, see User-Defined Time Constants |
| 8 | Continuous display of shared screen |
| 0 | Automatic switching over is disabled |

5.3.1. User-Defined Time Constants

Navigation

(example item **10** – Display of time)

Menu:

Item:

Available values:

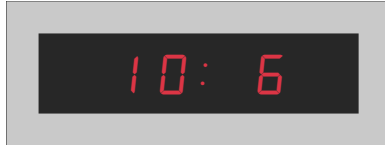
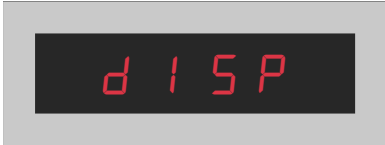

0 - 60 (seconds)

Available Settings

| Menu item | Function | Values |
|-----------|--------------------------|----------------|
| 10 | Display of time | 0-60 (seconds) |
| 11 | Display of date | 0-60 (seconds) |
| 12 | Display of calendar week | 0-60 (seconds) |
| 13 | Display of temperature 1 | 0-60 (seconds) |
| 14 | Display of humidity 1 | 0-60 (seconds) |
| 15 | Display of pressure 1 | 0-60 (seconds) |
| 16 | Display of temperature 2 | 0-60 (seconds) |
| 17 | Display of humidity 2 | 0-60 (seconds) |
| 18 | Display of pressure 2 | 0-60 (seconds) |

5.4. 12-Hour Format

Navigation

Menu:

Item:

Available values:

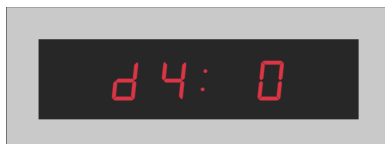
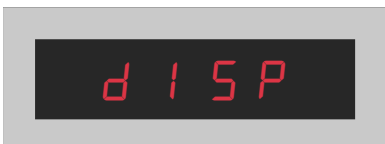

0, 1

Description

The 12-hour format is widely used convention to represent time within 12-hour cycle, typically with **a.m.** and **p.m.** designations. The time covers 12-hour period, starting from midnight (12:00 AM) end ending at noon (11:59 AM), then continuing from noon (12:00 PM) until just before midnight (11:59 PM).

12-hour cycle is indicated by a dot at first digit in upper left corner .

a.m. (10:08)

p.m. (10:08)

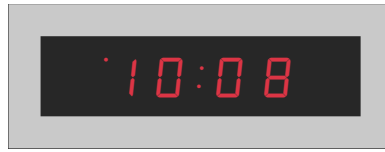
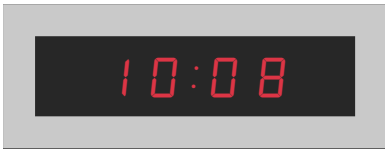

Available Settings

| Value | Description |
|-------------------|-------------|
| 0 (default value) | Disabled |
| 1 | Enabled |

5.5. Time with Leading Zero

Navigation

Menu:

Item:

Available values:

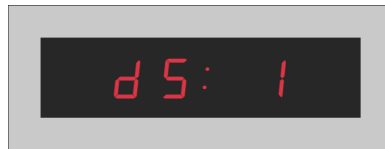
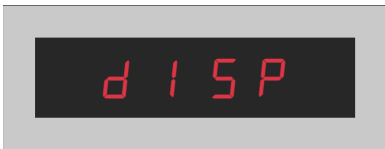

0 , 1

Description

Time with leading zero refers to representing hours, minutes and seconds in a time format with with zero before single-digit values. This ensures uniformity in time display and enhances readability.

Time without leading zero

Time with leading zero

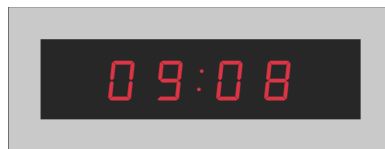
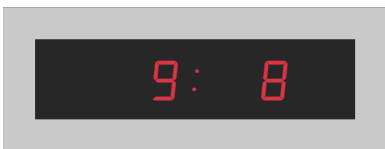

Available Settings

| Value | Description |
|-------|------------------------------------|
| 0 | Time with leading zero is disabled |

| Value | Description |
|--------------------------|-----------------------------------|
| <i> </i> (default value) | Time with leading zero is enabled |

5.6. Date with Leading Zero

Navigation

Menu:

Item:

Available values:

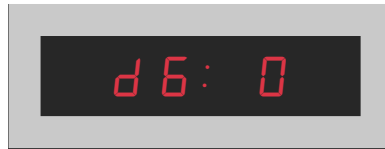
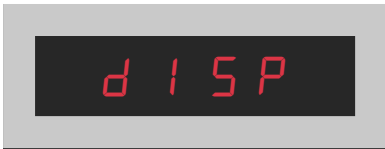

0, 1

Description

Date with leading zero refers to representing days, month and years in a date format with with zero before single-digit values. This ensures uniformity in time display and enhances readability.

Date without leading zero

Date with leading zero

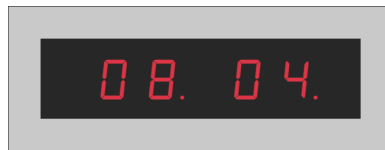
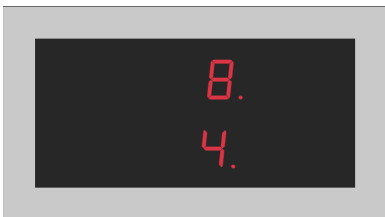

Available Settings

| Value | Description |
|--------------------------|------------------------------------|
| <i>0</i> (default value) | Date with leading zero is disabled |
| <i> </i> | Date with leading zero is enabled |

5.7. Clock Address for IR Remote Controller

Changed in version r7.15: This item has been moved to the **5 4 5 6** menu item **c 3**.

Navigation

Menu:

Item:

Available values:

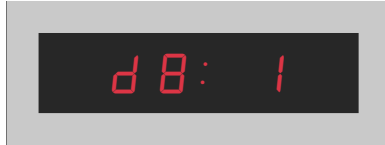

1 - 99

Description

The clock address for an IR remote controller is a specific identifier assigned to digital clock. This code serves as unique “address” that allows the remote controller to communicate and control particular clock. The clock control address is essential for ensuring that the remote controller signals and commands are received by the target device.

Available Settings

| Value(s) | Description |
|----------|-------------------|
| 1 - 99 | Set clock address |



More information can be found in Clock Address Display chapter.

5.8. IR Remote Controller Auto-Lock

Changed in version r7.15: This item has been moved to the **5 4 5 6** menu item **c 4**.

Navigation

Menu:

Item:

Available values:

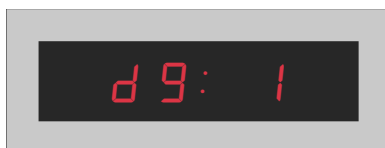
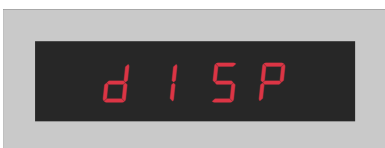

0 - 60, U

Description

This feature ensures the IR reception lock of digital clock after a specific period of inactivity (since the last press of any button on the IR remote controller), preventing unintentional button presses on the IR remote controller.

Available Settings

| Value(s) | Description |
|------------------|--|
| 1 - 60 (minutes) | Time in minutes for auto-lock since last press of a button on IR remote controller |

| Value(s) | Description |
|----------|------------------|
| U | Auto-Lock is OFF |



More information can be found in Automatic Lock .

5.9. Remote Control Lock

Changed in version r7.15: These setting has been moved to the **5 9 5 E** menu (see Remote Control Lock chapter).

The clock can be locked against unauthorized or unwanted operation using the remote controller.

5.9.1. Manual Lock

To lock all clock within the range of IR remote controller beam, long-press the **F2** button. Clock lock is indicated by displaying **L O C** on the clock display.



5.9.2. Automatic Lock



To set the IR remote controller auto-lock after time period, navigate to the **d I S P** menu item **d 9** (see IR Remote Controller Auto-Lock chapter).

Automatic lock of the clock after **x** minutes is not indicated on the display.

5.9.3. Clock Address Display



To set clock address for IR remote controller, navigate to the **d I S P** menu item **d 8** (see Clock Address for IR Remote Controller chapter).

The address display is enabled by press of the **F3** button and is indicated on the display as **A xx** .



The address is displayed only when the clock is locked.

xx represents the set address with initial zero.



A 0 1 → Clock Address 1

5.9.4. Unlocking the Clock

To unlock all clocks within the range of the IR remote controller beam, long-press the **F1** button. Clock unlock is indicated by displaying **U N L** on the clock display.



To unlock only specific clock with a specific address, press the **F1** button followed by the clock address in two-digit format with leading zero.



Thus, for a clock with address 5, the sequence will be as follows:

Press the **F1** button → Set the first digit number to **0** → Set the second digit number to **5**

Successful unlocking is indicated by displaying **UNL** on the clock display.

6 Second Line Display Settings



This setting is available only for digital clock with **two lines** display.

The display shows following:



Enter digital clock’s main menu and navigate to **d 1 P 2** submenu. Enter by pressing the **PB2L** push-button or the **OK** button on the remote controller.

Display Settings Summary

| Menu Item | Description | Value(s) |
|-----------|--|--------------------------|
| d 3 | Time Constants for Automatic Data Switching Over | 1, 2 *, 3, 4, 5, 6, U, 0 |
| d 4 | 12-Hour Format | 0 *, 1 |
| d 5 | Time with Leading Zero | 0, 1 * |
| d 6 | Date with Leading Zero | 0 *, 1 |
| i 0 | Display of Time (User Defined) | 0 - 6 0 [s] |
| i 1 | Display of Date (User Defined) | 0 - 6 0 [s] |
| i 2 | Display of Calendar Week (User Defined) | 0 - 6 0 [s] |
| i 3 | Display of Temperature 1 (User Defined) | 0 - 6 0 [s] |
| i 4 | Display of Humidity 1 (User Defined) | 0 - 6 0 [s] |
| i 5 | Display of Pressure 1 (User Defined) | 0 - 6 0 [s] |
| i 6 | Display of Temperature 2 (User Defined) | 0 - 6 0 [s] |
| i 7 | Display of Humidity 2 (User Defined) | 0 - 6 0 [s] |
| i 8 | Display of Pressure 2 (User Defined) | 0 - 6 0 [s] |

Default values are indicated with *, e.g., 1 *.

6.1. Time Constants for Automatic Data Switching Over

Navigation

Menu:

Item:

Available values:

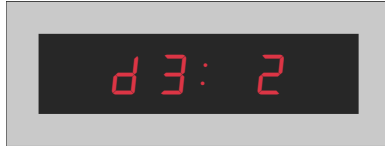

1, 2, 3, 4, 5, 6, U, 0

Description

This settings allows to choose the displayed data together with or without automatic switching over to next data. The time sequence of corresponding figures can be user-defined or predefined time sequence can be used.

Available Settings

| Value(s) | Description |
|-------------------|--|
| 1 | Continuous display of time |
| 2 (default value) | Continuous display of date |
| 3 | Continuous display of temperature |
| 4 | Continuous display of stopwatch |
| 5 | Display sequence: time 6 s, date 3 s |
| 6 | Display sequence: time 8 s, date 3 s, temperature 3 s |
| U | Time constants set up by user in seconds for each specific displayed data, see User-Defined Time Constants |
| 0 | Automatic switching over is disabled |

6.1.1. User-Defined Time Constants

Navigation

(example item 10 – Display of time)

Menu:

Item:

Available values:

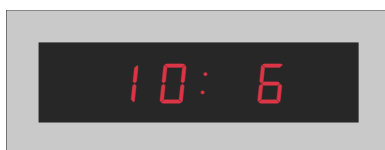
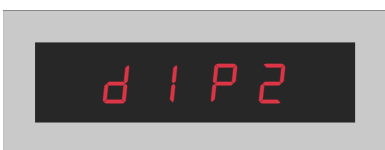

0 - 60 (seconds)

Available Settings

| Menu item | Function | Values |
|-----------|--------------------------|----------------|
| 10 | Display of time | 0-60 (seconds) |
| 11 | Display of date | 0-60 (seconds) |
| 12 | Display of calendar week | 0-60 (seconds) |
| 13 | Display of temperature 1 | 0-60 (seconds) |
| 14 | Display of humidity 1 | 0-60 (seconds) |
| 15 | Display of pressure 1 | 0-60 (seconds) |
| 16 | Display of temperature 2 | 0-60 (seconds) |
| 17 | Display of humidity 2 | 0-60 (seconds) |
| 18 | Display of pressure 2 | 0-60 (seconds) |

6.2. 12-Hour Format

Navigation

Menu:

Item:

Available values:

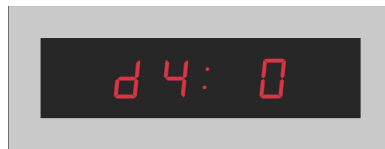

0, 1

Description

Description

The 12-hour format is widely used convention to represent time within 12-hour cycle, typically with **a.m.** and **p.m.** designations. The time covers 12-hour period, starting from midnight (12:00 AM) end ending at noon (11:59 AM), then continuing from noon (12:00 PM) until just before midnight (11:59 PM).

12-hour cycle is indicated by **a dot at first digit in upper left corner** .

a.m. (10:08)

p.m. (10:08)

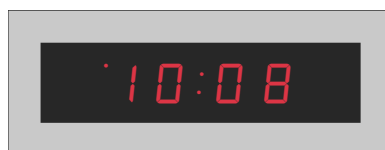
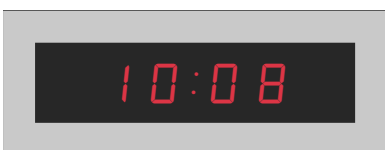

Available Settings

| Value | Description |
|-------------------|-------------|
| 0 (default value) | Disabled |
| 1 | Enabled |

6.3. Time with Leading Zero

Navigation

Menu:

Item:

Available values:

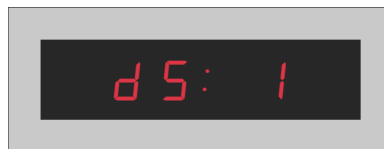
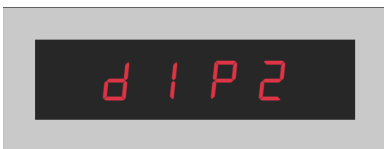

0, 1

Description

Time with leading zero refers to representing hours, minutes and seconds in a time format with with zero before single-digit values. This ensures uniformity in time display and enhances readability.

Time without leading zero

Time with leading zero

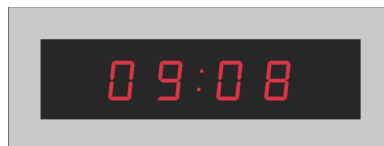
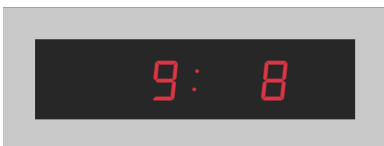

Available Settings

| Value | Description |
|-------------------|------------------------------------|
| 0 | Time with leading zero is disabled |
| 1 (default value) | Time with leading zero is enabled |

6.4. Date with Leading Zero

Navigation

Menu:



Item:

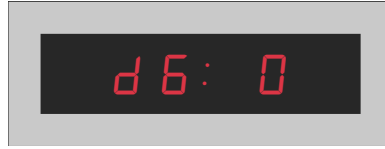

Available values:

1, 2, 3, 4, 5, 6, 0, 0

Description

Date with leading zero refers to representing days, month and years in a date format with with zero before single-digit values. This ensures uniformity in time display and enhances readability.

Date without leading zero

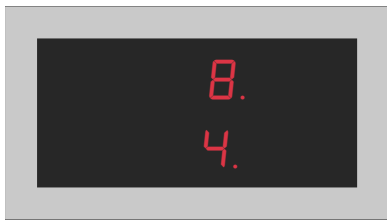

Date with leading zero

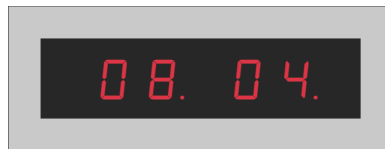

Available Settings

| Value | Description |
|-------------------|------------------------------------|
| 0 (default value) | Date with leading zero is disabled |
| 1 | Date with leading zero is enabled |

7 Synchronization Settings

The display shows following:



Enter digital clock's main menu and navigate to **SYNC** submenu. Enter by pressing the **PB2L** push-button or the **OK** button on the remote controller.

Synchronization Settings Summary

| Menu Item | Description | Value(s) |
|-----------|---|---------------------|
| 01 | Timezone of Synchronization Source | 0 - 64, A |
| 02 | Type of Synchronization | 1 - 11, A |
| 04 | MOBALine Time Zones | 1 - 20, 0 |
| 05 | Server MOBATIME Time Zones | 1 - 15, 0 |
| 06 | Protocol for RS-485 Communication | 1, 2 |
| 07 | Clock Address for Serial Protocols | 1 - 31, L |
| 08 | Modulation Speed for RS-485 | 1, 2, 3, 4, 5, 6, 7 |
| 09 | Number of Data Bits | 8, 7, * |
| 10 | Number of Stop Bits | 1, 2 |
| 11 | Parity | n, o, E, * |
| 12 | Timeout for Indication of State without Synchronization | t o * |
| 13 | Offset of Displayed Time | o F * |

Default values are indicated with •, e.g., 1 •.

Values with * have an accessible submenu, e.g., 1P •.

7.1. Timezone of Synchronization Source

Navigation

Menu:

Item:

Available values:

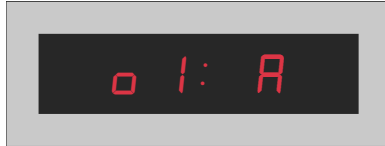
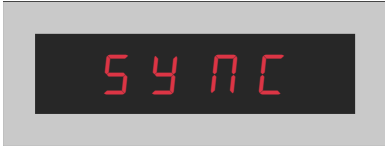

0 - 64, A

Description

Timezone synchronization is process used to ensure that timekeeping is accurately aligned with a specific timezone. This is essential for coordinating activities, scheduling events and maintaining consistency in a globalized world.

Available Settings

| Value(s) | Description |
|----------|---|
| 0 - 64 | Timezone entries, see Timezones Table chapter |
| A | Automatically set timezone |

7.2. Type of Synchronization

Navigation

Menu:

Item:

Available values:

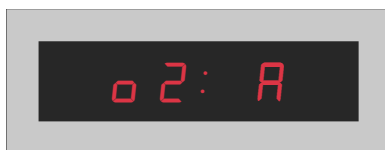
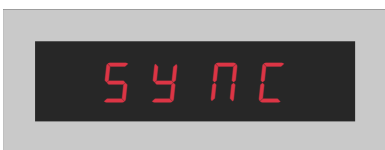

0 - 12, A

For a proper synchronization process, you must specify the type of source used in your time system.

Available Settings

| Value | Description |
|----------------|--|
| A | Autodetection (MOBALine, MOBATIME serial code, DCF, IRIG-B or NTP) |
| 1 | Autonomous operation without synchronization |
| 2 ¹ | Synchronization DCF |
| 3 ¹ | MOBATIME serial code |
| 4 ¹ | MOBALine |

| Value | Description |
|-------------------|---|
| 5 ¹ | 24 V VDC impulses, minute intervals |
| 6 ¹ | 24 V VDC impulses, half minute intervals |
| 7 ¹ | 24 V VDC impulses, second intervals |
| 8 ¹ | DCF-FSK- IRIG-B standard, IRIG-B 123, IRIG-B DIEM, AFNOR A, AFNOR C |
| 9 ¹ | Active DCF code |
| 10 ² | GPS |
| 11 ³ | RS-485 |
| 12 ^{3 4} | Shared parameters from Master clock |

- 1 only for digital clock synchronized by LGC variant
- 2 only for digital clock synchronized by GPS variant
- 3 only with RS-485 option
- 4 available only when the **S h r E** menu item **E 7** (Sharing Time chapter) is set to value **2**

7.3. Master Clock Time Zones

This chapter provides clarification regarding the functionality of Master Clock System in simultaneous transmission of main local time alongside with preconfigured time zones.

Users have the option to select and display any of these preconfigured time zones.



If the item **o 4 / o 5** is set to value **0** , received time on digital clock will set according to Timezone of Time and Date (**d 15 P** menu item **d 2**).

If you set any preconfigured time zone on your digital clock, it will inherit the time definition from Master Clock (the Timezone of Time and Date - **d 15 P** menu item **d 2** - must be set to value **A**).

7.3.1. MOBALine Time Zones



This setting is available only for digital clocks with LGC variant.

Navigation

Menu:

Item:

Available values:

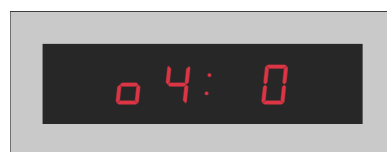

1 - 20 , A

Available Settings

| Value(s) | Description |
|----------|-------------------------|
| 1 - 20 | Preconfigured timezones |
| 0 | Off |

7.3.2. Server MOBATIME Time Zones



This setting is available only for digital clocks with NTP, PoE, WiFi and WiFi5 variant.



Menu : SYNC
 Item : 05
 Values : 1 - 15, 0

Navigation

Menu:

Item:

Available values:

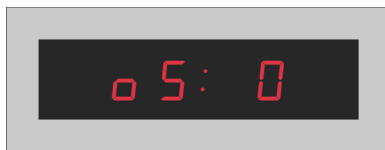
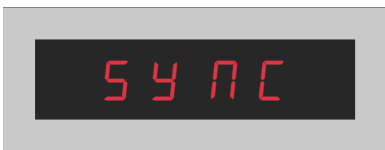

1 - 15, 0

Available Settings

| Value(s) | Description |
|----------|-------------------------|
| 1 - 15 | Preconfigured timezones |
| 0 | Off |

7.4. Protocol for RS-485 Communication



This setting is available only for digital clocks with RS-485 option.

Navigation

Menu:

Item:

Available values:

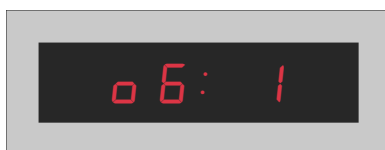
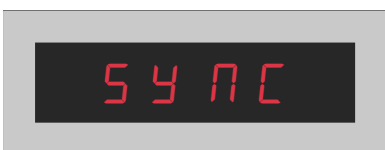

1, 2

Description

The protocol defines the specific rules and conventions that devices must follow when transmitting and receiving data over an RS-485 network.

Available Settings

| Value | Description |
|-------------------|-------------------|
| 1 (default value) | IF 482 |
| 2 | Supervised RS-485 |

7.5. Clock Address for Serial Protocols



This setting is available only for digital clocks with RS-485 option.

Navigation

Menu:

Item:

Available values:

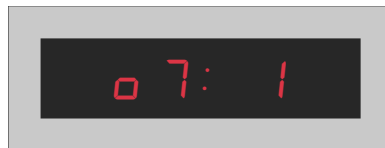
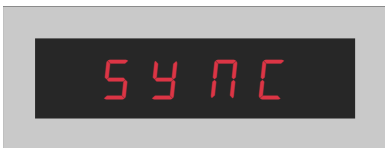

1 - 3 1, L

Description

Clock address plays a critical role in synchronizing the timing of data transmission between devices.

Available Settings

| Value(s) | Description |
|----------|----------------------|
| 1 - 3 1 | Clock address number |
| L | Listen only |

7.6. Modulation Speed for RS-485



This setting is available only for digital clocks with RS-485 option.

Navigation

Menu:

Item:

Available values:

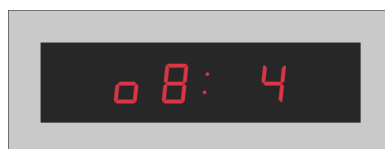
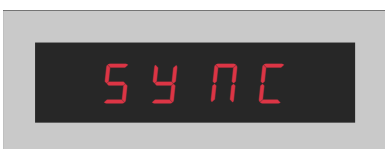

1, 2, 3, 4, 5, 6, 7

Description

Modulation speed, in context of RS-485 communication, refers to rate at which digital data is encoded, modulated and transmitted over the RS-485 serial bus. It plays a crucial role in determining the data transfer rate between devices.

Available Settings

| Value | Description |
|-------------------|-------------|
| 1 | 1 200 Baud |
| 2 | 2 400 Baud |
| 3 | 4 800 Baud |
| 4 (default value) | 9 600 Baud |
| 5 | 19 200 Baud |
| 6 | 38 400 Baud |
| 7 | 57 600 Baud |

7.7. Transmission Parameters for RS-485



These settings are available for digital clocks only with RS-485 option.

7.7.1. Number of Data Bits

Navigation

Menu:

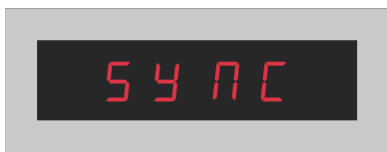

Item:

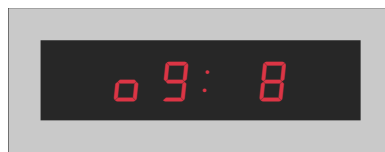

Available values:

8, 7

Description

Data bits carry the actual information or payload being sent. The number of data bits determines the size of data field.

Available Settings

| Value | Description |
|-------------------|-------------|
| 8 | 8 bits |
| 7 (default value) | 7 bits |

7.7.2. Number of Stop Bits

Navigation

Menu:

Item:

Available values:

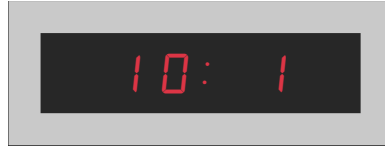
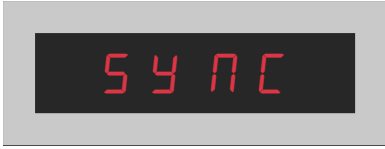

1, 2

Description

One or more stop bits follow the data bits, indicating the end of data frame. Stop bits provide synchronization and framing.

Available Settings

| Value | Description |
|-------------------|-------------|
| 1 (default value) | 1 stop bit |
| 2 | 2 stop bits |

7.7.3. Parity

Navigation

Menu:

Item:

Available values:

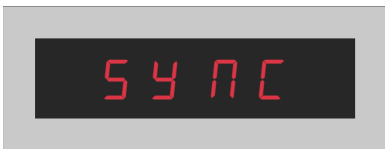

n, o, E

Description

Parity is a mechanism used to detect errors in the transmission of data between devices in RS-485 network. It involves the inclusion of an extra bit, known as parity bit, within each data frame. The parity bit is used to check whether the transmitted data has been received accurately.

Available Settings

| Value | Description |
|-------------------|-------------|
| n | No parity |
| o | Odd parity |
| E (default value) | Even parity |

7.8. Timeout for Indication of State without Synchronization

Navigation

Menu:

Item:

Available values:

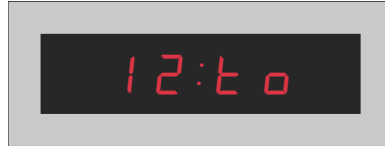
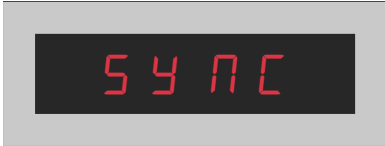

EO (submenu)

Description

This section defines the timeout period used before the clock indicates the state without synchronization.

This means that if no synchronization signal is received within set time interval, the system enters the no-sync state, which is visually indicated by **blinking colon(s)** on the display.

The default timeout value for indication of state without synchronization is **24 hours**.

Available Settings

Submenu EO for setting the timeout for signalling a state without synchronnization

| Value | Description |
|-------|--|
| ddd | Timeout value in hours set digit by digit in range 1–255 hours |

7.9. Offset of Displayed Time

Navigation

Menu:

Item:

Available values:

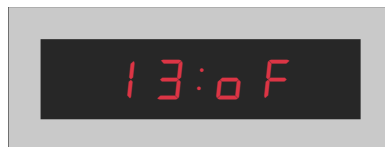
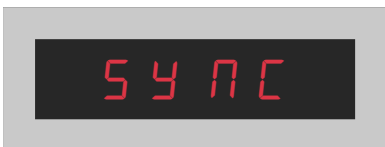

OF (submenu)

Description

Offset of displayed time refers to the adjustment made to a displayed time value to reflect a time difference relative to a reference point. This offset allows users to view time information that aligns with their preferences or requirements.

Available Settings

Submenu **F** for Setting the Offset of Displayed Time

| Value | Description |
|---------|---|
| - d d d | Timeout value in multiples of 10 ms set digit by digit in range -999 to 999 (*10 ms) Range of each digit is 0-9 - = negative offset value (e.g. -150 → offset value -1.5 s) |

8 Network Settings



Network settings are available only for NTP, PoE, PoE+, WiFi or WiFi5 digital clock variant.

The display shows following:



Enter digital clock’s main menu and navigate to **NET** submenu. Enter by pressing the **PB2L** push-button or the **OK** button on the remote controller.

Network Settings Summary

| Menu Item | Description | Value(s) |
|-----------|---|------------|
| n 1 | IP Mode | 0, 1, 2 |
| n 2 | Communication Mode | 0, 1 |
| n 3 | DHCPv4 Mode | 0, 1 |
| n 4 | IP Address | IP * |
| n 5 | Subnet Mask | SU * |
| n 6 | Default Gateway | GT * |
| n 7 | Multicast Address | MC * |
| n 8 | Unicast NTP Address | UC * |
| n 9 | NTP Polling Interval | P, * |
| 10 | Address Autoconfiguration (SLAAC) | 0, 1, * |
| 11 | DHCPv6 Mode | 0, 1, * |
| 12 | WiFi Mode | 1, 2, 3 |
| 13 | Multicast Mode for Configuration of Digital Clock | 0, 1 |
| 14 | SNMP Protocol | 0, 1, * |
| 15 | Web Server | 0, 1, * |
| 16 | Web Server Security Mode | 0, 1, 2, 3 |
| LOCL | Link Local Address | * |
| SLAC | Autoconfiguration SLAAC | * |
| DHCP | First Address from DHCPv6 | * |

| Menu Item | Description | Value(s) |
|-----------|--------------------------------------|----------|
| MANU | Manually Set IPv6 Address | * |
| PREF | Prefix for Manually Set IPv6 Address | * |
| GATE | Gateway from Autoconfiguration SLAAC | * |
| MAC | MAC Address | * |

Default values are indicated with *, e.g., 1*. Values with * have an accessible submenu, e.g., IP*.

8.1. IP Mode

Navigation

Menu:



Item:



Available values:

0, 1, 2

Description

IP mode refers to specific configuration and settings. It defines how devices within a network interact, how they are addressed and how data is routed.

IP mode determines whether devices within a network use IPv4 or IPv6. IPv4 is older and more widely used version, but on the other hand IPv6 is designed to address the limitation of IPv4 and accommodate the growing number of connected devices.

Available Settings

| Value | Description |
|-------------|--|
| 0 (default) | NTP, PoE: IPv4 / IPv6 WiFi: not supported |
| 1 | NTP, PoE: IPv4 WiFi: IPv4 |
| 2 | NTP, PoE: IPv6 WiFi: not supported |

8.2. Communication Mode

Navigation

Menu:

Item:

Available values:



0, 1

Description

Communication modes are fundamental to how devices interact and share data within a network environment. These modes determine the rules, protocols and mechanisms governing data transfer.

Unicast communication involves sending data from one source to one specific destination device. It is a one-to-one communication mode.

Multicast communication involves sending data to specific group (group of devices, multicast group). Only devices that have joined the multicast group can receive the data.

Available Settings

| Value | Description |
|-------------------|-------------|
| 0 (default value) | Unicast |
| 1 | Multicast |

8.3. DHCPv4 Mode

Navigation

Menu:

Item:

Available values:

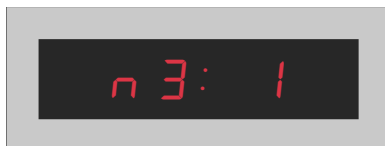

0, 1

Description

DHCPv4 (D ynamic H ost C onfiguration P rotocol for IP v4) is a network protocol used to automate and simplify the process of assigning and managing IP addresses and related network configuration information within IPv4-based network.

Available Settings

| Value | Description |
|-------|-----------------|
| 0 | DHCPv4 disabled |

| Value | Description |
|--------------------------|----------------|
| <i>i</i> (default value) | DHCPv4 enabled |

8.4. IP Address

Navigation

Menu:

Item:

Available values:

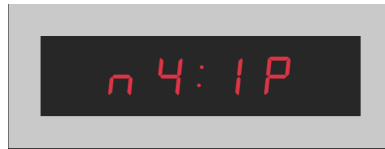

IP (submenu)

Description

An IP address (I nternet P rotocol address) is a unique numerical label assigned to each device connected to network that uses Internet protocol for communication. IP addresses serve as identifiers, allowing devices to send and receive data to and from one another across a network.

Here you can edit IPv4 network parameters in manual setting mode or display parameters assigned to DHCPv4.

Submenu

Submenu *IP* for Displaying and Editing IPv4 Address

| Value | Description | Range |
|----------|------------------------------------|---------------------------|
| <i>a</i> | 1 st octet IPv4 address | 0–255, set digit by digit |
| <i>b</i> | 2 nd octet IPv4 address | 0–255, set digit by digit |
| <i>c</i> | 3 rd octet IPv4 address | 0–255, set digit by digit |
| <i>d</i> | 4 th octet IPv4 address | 0–255, set digit by digit |

8.5. Subnet Mask

Navigation

Menu:

Item:

Available values:

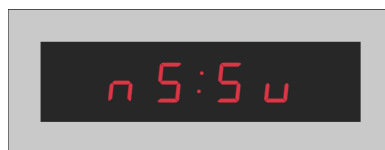

5u (submenu)

Description

Subnet mask is a numerical value used in networking to define the boundaries and division of IP addresses within a network. It works in conjunction with IP addresses, helping to determine which part of the IP address identifies the network and which part identifies individual device within that network.

Here you can edit IPv4 network parameters in manual setting mode or display parameters assigned to DHCPv4.

Submenu

Submenu 5 u for Displaying and Editing IPv4 Address

| Value | Description | Range |
|-------|------------------------------------|---------------------------|
| A | 1 st octet IPv4 address | 0–255, set digit by digit |
| b | 2 nd octet IPv4 address | 0–255, set digit by digit |
| c | 3 rd octet IPv4 address | 0–255, set digit by digit |
| d | 4 th octet IPv4 address | 0–255, set digit by digit |

8.6. Default Gateway

Navigation

Menu:

Item:

Available values:

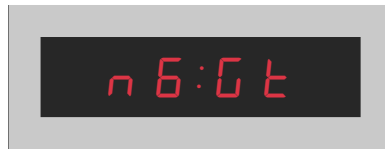

c (submenu)

Description

Default gateway serves as a key network device that facilitates communication between devices within a local network and devices in external networks.

Here you can edit IPv4 network parameters in manual setting mode or display parameters assigned to DHCPv4.

Submenu

Submenu c for Displaying and Editing IPv4 Address

| Value | Description | Range |
|-------|------------------------------------|---------------------------|
| A | 1 st octet IPv4 address | 0–255, set digit by digit |
| b | 2 nd octet IPv4 address | 0–255, set digit by digit |
| c | 3 rd octet IPv4 address | 0–255, set digit by digit |
| d | 4 th octet IPv4 address | 0–255, set digit by digit |

8.7. Multicast Address

Navigation

Menu:

Item:

Available values:

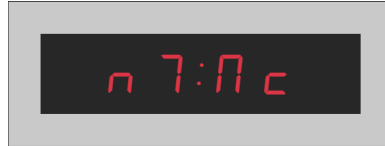

nc (submenu)

Description

Multicast address is a specialized type of IP address used in networking to deliver data packets from one sender to multiple recipients efficiently.

Here you can set the multicast group IPv4 address.



The multicast address can be set only if the Communication mode is set to multicast (the **NET** menu item **n2** is set to value **i**).

Submenu

Submenu nc for Displaying and Editing IPv4 Address

| Value | Description | Range |
|-------|------------------------------------|---------------------------|
| a | 1 st octet IPv4 address | 0–255, set digit by digit |
| b | 2 nd octet IPv4 address | 0–255, set digit by digit |
| c | 3 rd octet IPv4 address | 0–255, set digit by digit |
| d | 4 th octet IPv4 address | 0–255, set digit by digit |

8.8. Unicast NTP Address

Navigation

Menu:

Item:

Available values:

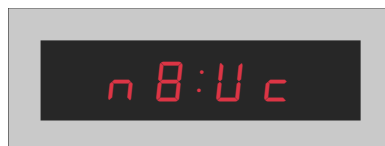

uc (submenu)

Description

Unicast NTP address refers to the specific IP address of an NTP server or time source to which a device sends requests for time synchronization.

Here you can set unicast NTP server IPv4 address.

Submenu

Submenu *U c* for Displaying and Editing IPv4 Address

| Value | Description | Range |
|----------|------------------------------------|---------------------------|
| <i>a</i> | 1 st octet IPv4 address | 0–255, set digit by digit |
| <i>b</i> | 2 nd octet IPv4 address | 0–255, set digit by digit |
| <i>c</i> | 3 rd octet IPv4 address | 0–255, set digit by digit |
| <i>d</i> | 4 th octet IPv4 address | 0–255, set digit by digit |

8.9. NTP Polling Interval

Navigation

Menu:

Item:

Available values:

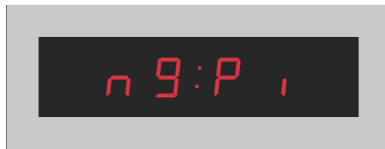

P , (submenu)

Description

NTP poll interval refers to the frequency at which a NTP client sends time synchronization requests (NTP polls) to its configured NTP servers on peers. It determines how often the client checks and adjusts its internal clock to maintain accurate and synchronized time.

Submenu

Submenu *P ,* for Setting of NTP Polling Interval

| Value | Description |
|--------------|--|
| <i>d d d</i> | Value of the polling interval set digit by digit in range 10–999 seconds The range of each digit is 0–9 |

8.10. Address Autoconfiguration (SLAAC)

Navigation

Menu:

Item:

Available values:

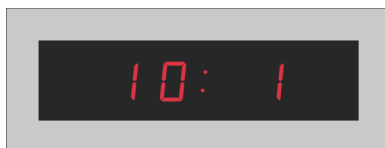

0 , 1

Description

Address autoconfiguration (SLAAC) is an IPv6 address configuration method that enables devices to automatically assign and configure their IPv6 addresses based on information provided in router advertisement messages. It simplifies the process of IP address assignment in IPv6 networks and is a fundamental part of the IPv6 addressing architecture.

Available Settings

| Value | Description |
|-------------------|----------------|
| 0 | SLAAC disabled |
| 1 (default value) | SLAAC enabled |

8.11. DHCPv6 Mode

Navigation

Menu:

Item:

Available values:

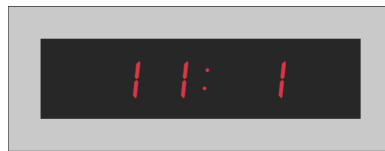

0, 1

Description

DHCPv6 (D ynamic H ost C onfiguration P rotocol for IP v6) is a network protocol used to dynamically assign IPv6 addresses and configuration information to devices within an IPv6 network. DHCPv6 mode determines how IPv6 address configuration is managed.

Available Settings

| Value | Description |
|-------------------|-----------------|
| 0 | DHCPv6 disabled |
| 1 (default value) | DHCPv6 enabled |

8.12. WiFi Mode



This setting is available only for digital clocks with WiFi or WiFi5 variant

Navigation

Menu:

Item:

Available values:



1, 2, 3

Description

WiFi Modes determine the capabilities and characteristics of the wireless network, including data rates, range and compatibility with different devices.

Description of individual modes can be found in Clock Operation > Network Clock Operation > WiFi Operation Modes chapter.

Available Settings

| Value | Description |
|-------------------|---|
| 1 (default value) | User-defined wireless network (defined via MOBA-NMS or Web Interface) |
| 2 | Default wireless network: MOBA-WIFI |
| 3 | AP mode |

8.13. Multicast Mode for Configuration of Digital Clock

Navigation

Menu:

Item:

Available values:

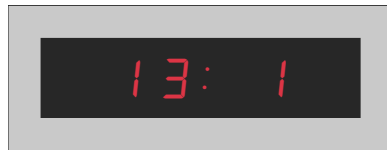

0, 1

Description

Multicast mode for the configuration of digital clock refers to a method of distributing time configuration information and updates to multiple digital clocks over a network using multicast communication. This mode is commonly used in scenarios where you have a large number of digital clocks that need to be synchronized with a central time server.

Available Settings

| Value | Description |
|-------------------|------------------------|
| 0 | Disable multicast mode |
| 1 (default value) | Enable multicast mode |

8.14. SNMP Protocol

Navigation

Menu:

Item:

Available values:

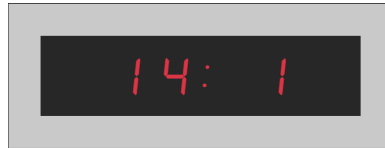

0, 1

Description

SNMP (Simple Network Management Protocol) is widely used network management protocol in networking. It is designed for monitoring and managing devices and network resources on IP networks. SNMP allows network administrators to collect information about network devices, configure their settings and receive notifications about network events.

Available Settings

| Value | Description |
|-------------------|--------------|
| 0 | Disable SNMP |
| 1 (default value) | Enable SNMP |

8.15. Web Server

Navigation

Menu:

Item:

Available values:

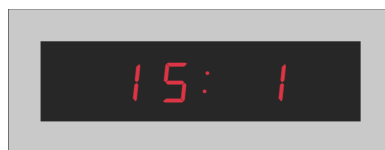

0, 1

Description

Thanks to web server, you can easily set-up, view and monitor digital clock.

Available Settings

| Value | Description |
|-------------------|--------------------|
| 0 | Disable web server |
| 1 (default value) | Enable web server |

8.16. Web Server Security Mode



This setting is available (visible) only if the Web Server is enabled – the **NET** menu item **15** is set to value **1** (see Web Server chapter).

Navigation

Menu:

Item:

Available values:

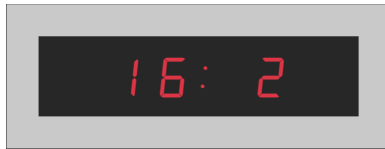

0, 1, 2, 3

Description

This setting allows you to configure the security mode of the web server, determining how web server requests are handled.

Available Settings

| Value(s) | Description |
|-------------------|------------------------|
| 0 | HTTP only |
| 1 | HTTPS only |
| 2 (default value) | HTTP and HTTPS |
| 3 | HTTP to HTTPS redirect |

8.17. Link Local Address

Navigation

Menu:

Item:

Available values:



submenu for displaying IPv6 address

Description

Link Local Address is type of IPv6 address that is used for communication within single network segment or link. Link Local Addresses are designed to work on the local network and are typically not routed beyond that network segment.

Submenu

Submenu for Displaying IPv6 Address (read only)

| Block name of IPv6 address | Value | Description | Range |
|----------------------------|---------|--|------------------|
| - b 1 - | - - - - | Hexadecimal value of the 1 st block of the IPv6 address | Cannot be edited |
| - b 2 - | - - - - | Hexadecimal value of the 2 nd block of the IPv6 address | Cannot be edited |
| - b 3 - | - - - - | Hexadecimal value of the 3 rd block of the IPv6 address | Cannot be edited |
| - b 4 - | - - - - | Hexadecimal value of the 4 th block of the IPv6 address | Cannot be edited |
| - b 5 - | - - - - | Hexadecimal value of the 5 th block of the IPv6 address | Cannot be edited |
| - b 6 - | - - - - | Hexadecimal value of the 6 th block of the IPv6 address | Cannot be edited |
| - b 7 - | - - - - | Hexadecimal value of the 7 th block of the IPv6 address | Cannot be edited |
| - b 8 - | - - - - | Hexadecimal value of the 8 th block of the IPv6 address | Cannot be edited |

8.18. Autoconfiguration SLAAC

Navigation

Menu:

Item:

Available values:



submenu for displaying IPv6 address

Description

Address autoconfiguration (SLAAC) is an IPv6 address configuration method that enables devices to automatically assign and configure their IPv6 addresses based on information provided in router advertisement messages. It simplifies the process of IP address assignment in IPv6 networks and is a fundamental part of the IPv6 addressing architecture.

Submenu

Submenu for Displaying IPv6 Address (read only)

| Block name of IPv6 address | Value | Description | Range |
|----------------------------|---------|--|------------------|
| - b 1 - | - - - - | Hexadecimal value of the 1 st block of the IPv6 address | Cannot be edited |
| - b 2 - | - - - - | Hexadecimal value of the 2 nd block of the IPv6 address | Cannot be edited |
| - b 3 - | - - - - | Hexadecimal value of the 3 rd block of the IPv6 address | Cannot be edited |
| - b 4 - | - - - - | Hexadecimal value of the 4 th block of the IPv6 address | Cannot be edited |
| - b 5 - | - - - - | Hexadecimal value of the 5 th block of the IPv6 address | Cannot be edited |
| - b 6 - | - - - - | Hexadecimal value of the 6 th block of the IPv6 address | Cannot be edited |
| - b 7 - | - - - - | Hexadecimal value of the 7 th block of the IPv6 address | Cannot be edited |
| - b 8 - | - - - - | Hexadecimal value of the 8 th block of the IPv6 address | Cannot be edited |

8.19. First Address from DHCPv6

Navigation

Menu:

Item:

Available values:



submenu for displaying IPv6 address

Description

In DHCPv6, the first address that a client typically requests is an IPv6 address for its network interface.

Submenu

Submenu for Displaying IPv6 Address (read only)

| Block name of IPv6 address | Value | Description | Range |
|----------------------------|---------|--|------------------|
| - b 1 - | - - - - | Hexadecimal value of the 1 st block of the IPv6 address | Cannot be edited |

| Block name of IPv6 address | Value | Description | Range |
|----------------------------|---------|--|------------------|
| - b 2 - | - - - - | Hexadecimal value of the 2 nd block of the IPv6 address | Cannot be edited |
| - b 3 - | - - - - | Hexadecimal value of the 3 rd block of the IPv6 address | Cannot be edited |
| - b 4 - | - - - - | Hexadecimal value of the 4 th block of the IPv6 address | Cannot be edited |
| - b 5 - | - - - - | Hexadecimal value of the 5 th block of the IPv6 address | Cannot be edited |
| - b 6 - | - - - - | Hexadecimal value of the 6 th block of the IPv6 address | Cannot be edited |
| - b 7 - | - - - - | Hexadecimal value of the 7 th block of the IPv6 address | Cannot be edited |
| - b 8 - | - - - - | Hexadecimal value of the 8 th block of the IPv6 address | Cannot be edited |

8.20. Manually Set IPv6 Address

Navigation

Menu:

Item:

Available values:



submenu for displaying IPv6 address

Description

Here you can view manually set IPv6 address which has been set in other way, e.g. web interface.

Submenu

Submenu for Displaying IPv6 Address (read only)

| Block name of IPv6 address | Value | Description | Range |
|----------------------------|---------|--|------------------|
| - b 1 - | - - - - | Hexadecimal value of the 1 st block of the IPv6 address | Cannot be edited |
| - b 2 - | - - - - | Hexadecimal value of the 2 nd block of the IPv6 address | Cannot be edited |
| - b 3 - | - - - - | Hexadecimal value of the 3 rd block of the IPv6 address | Cannot be edited |

| Block name of IPv6 address | Value | Description | Range |
|----------------------------|---------|--|------------------|
| - b 4 - | - - - - | Hexadecimal value of the 4 th block of the IPv6 address | Cannot be edited |
| - b 5 - | - - - - | Hexadecimal value of the 5 th block of the IPv6 address | Cannot be edited |
| - b 6 - | - - - - | Hexadecimal value of the 6 th block of the IPv6 address | Cannot be edited |
| - b 7 - | - - - - | Hexadecimal value of the 7 th block of the IPv6 address | Cannot be edited |
| - b 8 - | - - - - | Hexadecimal value of the 8 th block of the IPv6 address | Cannot be edited |

8.21. Prefix for Manually Set IPv6 Address

Navigation

Menu:

Item:

Available values:



submenu for displaying IPv6 address

Description

Prefix is a portion of the IPv6 address that represents the network segment to which the device or network interface belongs.

Submenu

Submenu for Displaying IPv6 Address (read only)

| Block name of IPv6 address | Value | Description | Range |
|----------------------------|---------|--|------------------|
| - b 1 - | - - - - | Hexadecimal value of the 1 st block of the IPv6 address | Cannot be edited |
| - b 2 - | - - - - | Hexadecimal value of the 2 nd block of the IPv6 address | Cannot be edited |
| - b 3 - | - - - - | Hexadecimal value of the 3 rd block of the IPv6 address | Cannot be edited |
| - b 4 - | - - - - | Hexadecimal value of the 4 th block of the IPv6 address | Cannot be edited |
| - b 5 - | - - - - | Hexadecimal value of the 5 th block of the IPv6 address | Cannot be edited |

| Block name of IPv6 address | Value | Description | Range |
|----------------------------|---------|--|------------------|
| - b 6 - | - - - - | Hexadecimal value of the 6 th block of the IPv6 address | Cannot be edited |
| - b 7 - | - - - - | Hexadecimal value of the 7 th block of the IPv6 address | Cannot be edited |
| - b 8 - | - - - - | Hexadecimal value of the 8 th block of the IPv6 address | Cannot be edited |

8.22. Gateway from Autoconfiguration SLAAC

Navigation

Menu:

Item:

Available values:



submenu for displaying IPv6 address

Description

Gateway in context of SLAAC is a critical network device that provides essential routing information to IPv6 devices. It is responsible for announcing the network's prefix and prefix length, allowing devices to configure their IPv6 addresses automatically.

Submenu

Submenu for Displaying IPv6 Address (read only)

| Block name of IPv6 address | Value | Description | Value | Range |
|----------------------------|---------|--|-------|------------------|
| - b 1 - | - - - - | Hexadecimal value of the 1 st block of the IPv6 address | | Cannot be edited |
| - b 2 - | - - - - | Hexadecimal value of the 2 nd block of the IPv6 address | | Cannot be edited |
| - b 3 - | - - - - | Hexadecimal value of the 3 rd block of the IPv6 address | | Cannot be edited |
| - b 4 - | - - - - | Hexadecimal value of the 4 th block of the IPv6 address | | Cannot be edited |
| - b 5 - | - - - - | Hexadecimal value of the 5 th block of the IPv6 address | | Cannot be edited |
| - b 6 - | - - - - | Hexadecimal value of the 6 th block of the IPv6 address | | Cannot be edited |
| - b 7 - | - - - - | Hexadecimal value of the 7 th block of the IPv6 address | | Cannot be edited |

| Block name of IPv6 address | Value | Description | Range |
|----------------------------|---------|--|------------------|
| - b 8 - | - - - - | Hexadecimal value of the 8 th block of the IPv6 address | Cannot be edited |

8.23. MAC Address

Navigation

Menu:

Item:

Available values:



submenu for displaying MAC address

Description

MAC address (**M**edia **A**ccess **C**ontrol) is unique identifier assigned to a network interface card or controller in a device. It serves as a hardware address that distinguishes one network device from another on local network.

Submenu



Only last two octet can be defined under special conditions; conditions not yet set.

Submenu for Displaying MAC Address

| Item | Description | Values |
|--------------|--------------------------------------|------------|
| L 1:00 | 1 st octet of MAC address | 0x00 |
| L 2:16 | 2 nd octet of MAC address | 0x16 |
| L 3:9 1 | 3 rd octet of MAC address | 0x91 |
| L 4:F d | 4 th octet of MAC address | 0xFD, 0xFD |
| L 5:00 - F F | 5 th octet of MAC address | 0x00-0xFF |
| L 6:00 - F F | 6 th octet of MAC address | 0x00-0xFF |

9 Sensor Settings

The display shows following:



Enter digital clock’s main menu and navigate to *SEN1* or *SEN2* submenu. Enter by pressing the **PB2L** push-button or the **OK** button on the remote controller.



Use *SEN1* to configure Sensor 1 and *SEN2* to configure Sensor 2.
 For consistency, the navigation menu throughout this user guide uses *SEN1*.

Sensor Settings Summary

| Menu Item | Description | Value(s) |
|-----------|----------------------------------|--|
| <i>E1</i> | Sensor Type | <i>P3, P2, P1, -, 0, 1, 2, 3, 4, 5, 6, 7, 13, 14, 15</i> |
| <i>E2</i> | Displayed Temperature Correction | <i>CE *</i> |
| <i>E3</i> | Temperature Units Display | <i>0, 1 •</i> |
| <i>E4</i> | Temperature Units | <i>°C, °F</i> |
| <i>E6</i> | Displayed Humidity Correction | <i>CH *</i> |
| <i>E7</i> | Humidity Units Display | <i>0, 1 •</i> |
| <i>E8</i> | Humidity Units | <i>rH; Hr</i> |
| <i>I0</i> | Displayed Pressure Correction | <i>CP *</i> |
| <i>I1</i> | Pressure Units Display | <i>0, 1 •</i> |
| <i>I2</i> | Pressure Units | <i>hP •</i> |
| <i>I4</i> | Temperature Preset Value | <i>PE *</i> |
| <i>I5</i> | Humidity Preset Value | <i>PH *</i> |
| <i>I6</i> | Pressure Preset value | <i>PP *</i> |
| <i>I7</i> | Input Number for Sensor One-Wire | <i>1, 2</i> |
| <i>22</i> | Communication Protocol Type | <i>1, 2</i> |
| <i>23</i> | IP Address | <i>IP *</i> |

Default values are indicated with *•*, e.g., *1•*.

Values with *** have an accessible submenu, e.g., *1P**.

9.1. Sensor Type

Navigation

Menu:



Item:



Available values:

P 3, P 2, P 1, -, 0, 1, 2, 3, 4, 5, 6, 7, 13, 14, 15

Description

There are numerous sensor types, each optimized for particular application.

Available Settings

| Value | Sensor Type |
|--------------------------|-------------------------|
| <i>P 3</i> | TPHB preset value |
| <i>P 2</i> | TPH preset value |
| <i>P 1</i> | TP preset value |
| <i>-</i> | No sensor |
| <i>0</i> (default value) | TP 3m / TP 15m / TP 30m |
| <i>1</i> | TPH 1m |
| <i>2</i> ¹ | TP LAN |
| <i>3</i> ¹ | TP LAN PoE |
| <i>4</i> ¹ | TPHP LAN |
| <i>5</i> ¹ | TPHP LAN PoE |
| <i>6</i> ¹ | TPH PoE |
| <i>7</i> ¹ | TPHB LAN |
| <i>13</i> ¹ | TP Shared |
| <i>14</i> ¹ | TPH Shared |
| <i>15</i> ¹ | TPHB Shared |

¹ only with NTP, PoE, WiFi or WiFi5 variant

9.2. Input Number for Sensor One-Wire

Navigation

Menu:

Item:

Available values:

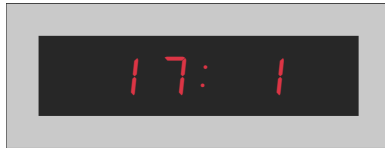

1, 2

Available Settings

| Value(s) | Description |
|-------------------|-------------|
| 1 (default value) | Input TEMP1 |
| 2 | Input TEMP2 |

9.3. Temperature Sensor

9.3.1. Displayed Temperature Correction

Navigation

Menu:

Item:

Available values:

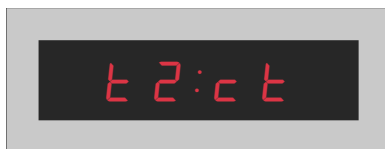

c t (submenu)

Description

This setting ensures accuracy and reliability of displayed temperature. Temperature sensors may have inherent inaccuracies or drift over time.

Submenu

Submenu c t for setting the temperature correction

| Value(s) | Description | Range |
|----------|--|---|
| - d.d | Setting of the displayed temperature correction on display | - = negative value d.d = value of correction set digit by digit, the range of each digit is 0-9 Range: -9.9 to 9.9 °C |

9.3.2. Temperature Units Display

Navigation

Menu:

Item:

Available values:

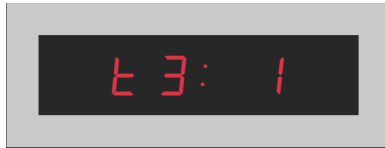

0, 1

Available Settings

| Value(s) | Description |
|-------------------|-------------------------------|
| 0 | Disabled (no units displayed) |
| 1 (default value) | Enabled (units displayed) |

9.3.3. Temperature Units

Navigation

Menu:

Item:

Available values:

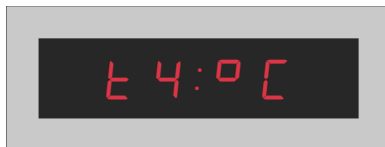

°C, °F

Description

Temperature sensor units are degrees Celsius or Fahrenheit.

The Celsius scale is widely used for measuring temperature in most of the world. It is based on the freezing point (0 °C) and boiling point (100 °C) of water under standard atmospheric pressure at sea level. It is the default unit used for temperature sensors.

The Fahrenheit scale is mainly used in the United States. It is based on the freezing point (32 °F) and boiling point (212 °F) of water under standard atmospheric pressure at sea level.

Available Settings

| Value(s) | Description |
|--------------------|--------------------|
| °C (default units) | Celsius degrees |
| °F | Fahrenheit degrees |

9.3.4. Temperature Preset Value

Navigation

Menu:

Item:

Available values:

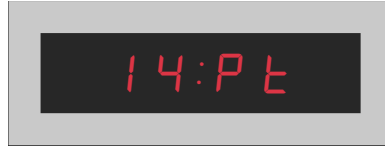

PE (submenu)

Description

The sensor preset value ensures that your defined value is displayed, regardless of the sensor reading or even if the sensor is not connected at all.

Here you can set the preset temperature value.

Submenu

Submenu PE for Setting the Preset Temperature Value

| Value(s) | Description | Range |
|----------|---|--|
| d d d | Setting of the preset temperature value | d d d = preset value set digit by digit, the range of each digit is 0-9 Range: -99 to 999 |

9.4. Humidity Sensor

9.4.1. Displayed Humidity Correction

Navigation

Menu:

Item:

Available values:

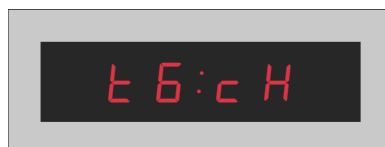

cH (submenu)

Description

This setting ensures accuracy and reliability of displayed humidity. Humidity sensors may have inherent inaccuracies or drift over time.

Submenu

Submenu *c H* for Setting the Humidity Correction

| Value(s) | Description | Range |
|--------------|---|---|
| - <i>d.d</i> | Setting of the displayed humidity correction on display | - = negative value <i>d.d</i> = value of correction set digit by digit, the range of each digit is 0-9 Range: -9.9 to 9.9 |

9.4.2. Humidity Units Display

Navigation

Menu:

Item:

Available values:

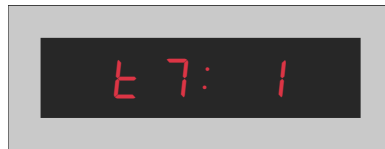

0, 1

Available Settings

| Value(s) | Description |
|--------------------------|-------------------------------|
| <i>0</i> | Disabled (no units displayed) |
| <i>1</i> (default value) | Enabled (units displayed) |

9.4.3. Humidity Units

Navigation

Menu:

Item:

Available values:

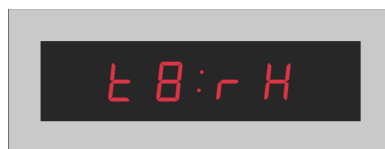

rH, Hr

Description

Humidity is represented in relative humidity units (rh or Hr). Relative humidity is the most common unit for expressing humidity levels. It represents the amount of water vapor in the air as a percentage of the maximum amount of water vapor the air can hold at a given temperature and pressure.

Relative humidity values range from 0% (completely dry air) to 100% (saturated air, where the air cannot hold any more moisture).

Available Settings

| Value(s) | Description |
|--------------------|-------------------|
| r H (default unit) | Relative humidity |
| H r | |

9.4.4. Humidity Preset Value

Navigation

Menu:

Item:

Available values:

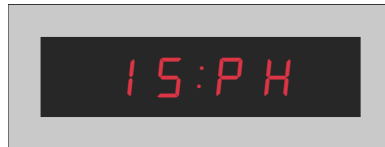

P H (submenu)

Description

The sensor preset value ensures that your defined value is displayed, regardless of the sensor reading or even if the sensor is not connected at all.

Here you can set the preset humidity value.

Submenu

Submenu P H for Setting the Preset Humidity Value

| Value(s) | Description | Range |
|----------|--------------------------------------|---|
| d d | Setting of the preset humidity value | d d.d = preset value set digit by digit, the range of each digit is 0-9 Range: -99 to 99 |

9.5. Pressure Sensor

9.5.1. Displayed Pressure Correction

Navigation

Menu:

Item:

Available values:



c P (submenu)

Description

This setting ensures accuracy and reliability of displayed pressure. Pressure sensors may have inherent inaccuracies or drift over time.

Submenu

Submenu c P for Setting the Pressure Correction

| Value(s) | Description | Range |
|----------|---|--|
| - d d d | Setting of the displayed pressure correction on display | - = negative value d d d = value of correction set digit by digit, the range of each digit is 0-9 Range: -999 to 999 |

9.5.2. Pressure Units Display

Navigation

Menu:

Item:

Available values:

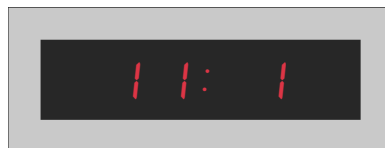

0, 1

Available Settings

| Value(s) | Description |
|-------------------|-------------------------------|
| 0 | Disabled (no units displayed) |
| 1 (default value) | Enabled (units displayed) |

9.5.3. Pressure Units

Navigation

Menu:

Item:

Available values:

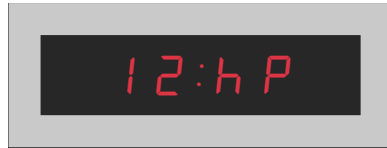

h P

Description

Pressure is a measure of the force applied to a given area. The default pressure sensor unit is Hectopascal (hPa, on sensor it is displayed as *h P*). It is equivalent to 100 Pa.

It is useful for expressing air pressure at various altitudes and for tracking changes in atmospheric pressure that can indicate weather patterns.

Available Setting

| Value(s) | Description |
|------------|-------------|
| <i>h P</i> | Hectopascal |

9.5.4. Pressure Preset value

Navigation

Menu:

Item:

Available values:

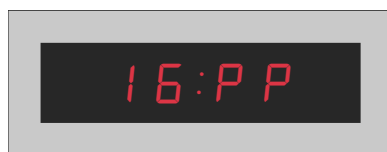

PP (submenu)

Description

The sensor preset value ensures that your defined value is displayed, regardless of the sensor reading or even if the sensor is not connected at all.

Here you can set the preset pressure value.

Submenu

Submenu *PP* for Setting the Preset Pressure Value

| Value(s) | Description | Range |
|----------------|--------------------------------------|--|
| <i>d d d d</i> | Setting of the preset pressure value | <i>d d . d</i> = preset value set digit by digit, the range of each digit is 0–9 Range: 0 to 9999 |

9.6. LAN Sensor



Available only with NTP, PoE, WiFi or WiFi5 variant.

9.6.1. Communication Protocol Type

Navigation

Menu:

Item:

Available values:

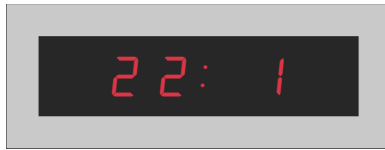

1, 2

Description

Type of communication protocol for LAN sensors depends on the specific requirements of the sensors and the network infrastructure in use.

Available Settings

| Value(s) | Description |
|----------|-------------|
| <i>1</i> | Modbus |
| <i>2</i> | Spinel |

9.6.2. IP Address

Navigation

Menu:

Item:

Available values:

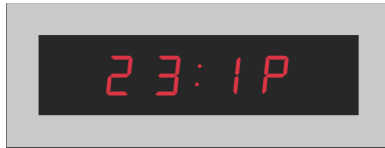

IP (submenu)

Description

An IP address (I nternet P rotocol address) is a unique numerical label assigned to each device connected to network that uses Internet protocol for communication.

IP addresses serve as identifiers, allowing devices to send and receive data to and from one another across a network.

Here you can set the IP address of sensor.

Submenu

Submenu *IP* for Displaying and Editing IPv4 Address

| Value | Description | Range |
|----------|------------------------------------|---------------------------|
| <i>A</i> | 1 st octet IPv4 address | 0–255, set digit by digit |
| <i>b</i> | 2 nd octet IPv4 address | 0–255, set digit by digit |
| <i>C</i> | 3 rd octet IPv4 address | 0–255, set digit by digit |
| <i>d</i> | 4 th octet IPv4 address | 0–255, set digit by digit |

10 Stopwatch Settings

The display shows following:



Enter digital clock's main menu and navigate to *STOP* submenu. Enter by pressing the **PB2L** push-button or the **OK** button on the remote controller.

Stopwatch Settings Summary

| Menu Item | Description | Value(s) |
|----------------|---|--------------------------------------|
| <i>P r E S</i> | Stopwatch Start Time | * |
| <i>E n d t</i> | Stopwatch End Time (New since version <i>r B . 1 7</i>) | * |
| <i>h 1</i> | Counting Direction | <i>1 , 2 , 3 , 4</i> |
| <i>h 2</i> | Control Mode | <i>1 , 2 , 3 , 4 , 5 , 6 , 7 , 8</i> |
| <i>h 3</i> | Counting Unit | <i>1 , 2 , 3 , 4</i> |
| <i>h 4</i> | Contact Closing | <i>0 , 1 - 3 0 , C , L</i> |
| <i>h 6</i> | External Keyboard Connection | <i>0 , 1</i> |
| <i>h 7</i> | Timeout to Switch to Default Display for BRB | <i>0 , 1 - 9 9</i> |
| <i>P r E 2</i> | Stopwatch Start Time (2nd Input) | * |
| <i>h 8</i> | External Button Input 1 Active Level | <i>0 , 1</i> |
| <i>h 9</i> | External Button Input 2 Active Level | <i>0 , 1</i> |
| <i>1 0</i> | Blinking Enable | <i>0 , 1</i> |
| <i>1 1</i> | Blink Period | <i>5 - 5 0</i> |
| <i>1 2</i> | Blink Duty | <i>1 0 - 9 0</i> |

Default values are indicated with *, e.g., *1* *.

Values with * have an accessible submenu, e.g., *1 P* *.

10.1. Stopwatch Start Time

Navigation

Menu:

Item:

Available values:



submenu

Description

This setting is crucial for setting the stopwatch start time for downwards counting.

Submenu

Submenu for Setting the Stopwatch Start Time

| Displayed Item | Value(s) | Description | Range |
|----------------|----------|----------------------|------------|
| HH:MM | HH | Hour setting | Range 0–99 |
| | MM | Minute setting | Range 0–59 |
| SS.HsHs | SS | Seconds setting | Range 0–59 |
| | HsHs | 1/100 second setting | Range 0–99 |

The available time settings depend on the selected counting unit (menu item **h 3**). According to the set counting unit, some fields are disabled and shown as dashes (- -).



- If **h 3:1** (1/100 second unit) is set: setting format **HH:MM** and **SS.HsHs** , maximum **99:59:59.990** .
- If **h 3:2** (second unit) is set: setting format **HH:MM** and **SS.--** , maximum **99:59:59.000** .
- If **h 3:3** (minute unit) is set: setting format **HH:MM** and **--.--** , maximum **99:59:00.000** .
- If **h 3:4** (day unit) is set: setting format **DD:DD** and **--.--** , maximum **9999** days.
Days are set as first two-digit field × 100 + second two-digit field.

10.2. Stopwatch End Time

✔ Added in version r8.17.

Navigation

Menu:

Item:

Available values:

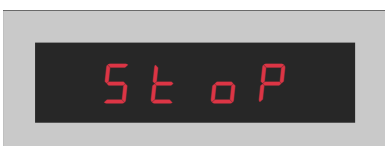

submenu

Description

This setting defines the end time for upwards counting. The stopwatch stops when the set time is reached. If relay activation (menu item **h 4**) is enabled, the relay is switched on for the defined duration at that moment.

Submenu

Submenu for Setting the Stopwatch End Time

| Displayed Item | Value(s) | Description | Range |
|----------------|----------|----------------------|------------|
| HH:MM | HH | Hour setting | Range 0–99 |
| | MM | Minute setting | Range 0–59 |
| SS.HsHs | SS | Seconds setting | Range 0–59 |
| | HsHs | 1/100 second setting | Range 0–99 |

The default end time is set to **99:59:59.990** .

The available time settings depend on the selected counting unit (menu item **h 3**). According to the set counting unit, some fields are disabled and shown as dashes (- -).



- If **h 3:1** (1/100 second unit) is set: setting format **HH:MM** and **SS.HsHs** , maximum **99:59:59.990** .
- If **h 3:2** (second unit) is set: setting format **HH:MM** and **SS.--** , maximum **99:59:59.000** .
- If **h 3:3** (minute unit) is set: setting format **HH:MM** and **--.---** , maximum **99:59:00.000** .
- If **h 3:4** (day unit) is set: setting format **DD:DD** and **--.---** , maximum **9999** days.
Days are set as first two-digit field × 100 + second two-digit field.

10.3. Counting Direction

Navigation

Menu:

Item:

Available values:

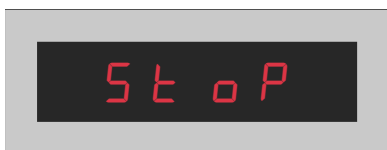

1, 2, 3, 4

Description

Stopwatch counting direction refers to whether it counts upwards or downwards (with stop at zero or with automatic restart from specified time value or keeping the count into negative values).

Available Settings

| Value | Description |
|--------------------------|-------------|
| 1 (default value) | Upwards |

| Value | Description |
|-------|--|
| 2 | Downwards from a set time value, with stop at zero |
| 3 | Downwards from a set time value, with automatic restart from specified time value |
| 4 | Downwards from a set time value, until zero and keeping the count into negative values |

10.4. Control Mode

Navigation

Menu:

Item:

Available values:

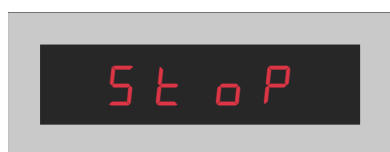

1, 2, 3, 4, 5, 6, 7, 8, 9

Available Settings

| Value | Description |
|-------------------|----------------|
| 1 (default value) | Control Mode 1 |
| 2 | Control Mode 2 |
| 3 | Control Mode 3 |
| 4 | Control Mode 4 |
| 5 | Control Mode 5 |
| 6 | Control Mode 6 |
| 7 | Control Mode 7 |
| 8 | Control Mode 8 |
| 9 | Control Mode 9 |

10.4.1. Control Mode 1

| Remote controller button | Push-button | Function |
|--------------------------|-------------|--|
| S/S | PB3 | Altering START - STOP - UNFREEZE of display (if freezed display) |
| HOLD | PB1 | FREEZE of displayed data with the counter proceeding in counting |
| RESET | PB1L | Setting the counter to zero in STOP operating mode for counting up, or return to a preset value in all other counting directions |

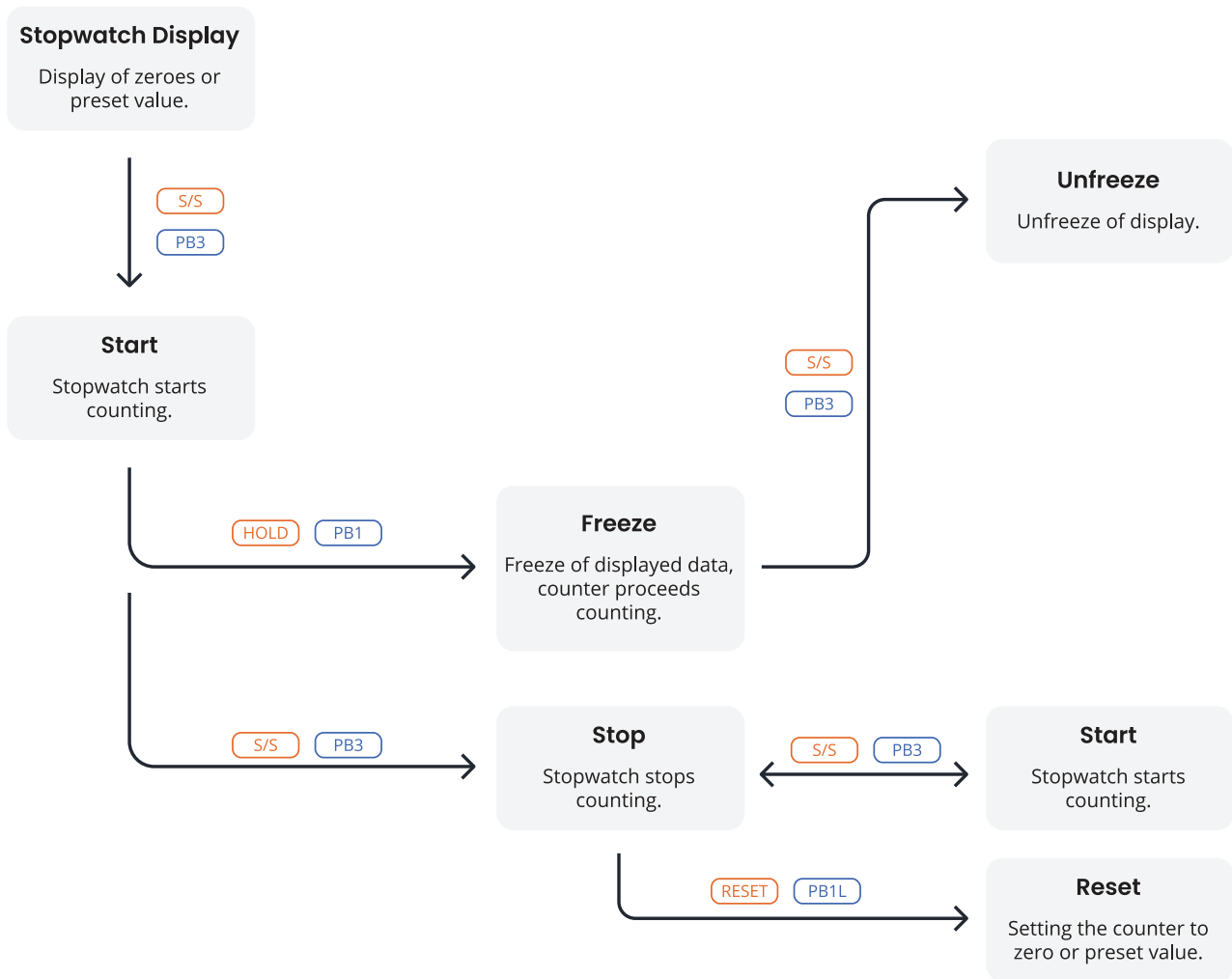

10.4.2. Control Mode 2

| Remote controller button | Push-button | Function |
|--------------------------|-------------|--|
| S/S | PB3 | Altering START - STOP - UNFREEZE of display (if freezed display) |
| HOLD | PB1 | First press of push-button causes the display to freeze on the respective time achieved and lets counter running; further activation of push-button shows the intermediate time elapsed from the first press |
| RESET | PB1L | Reset of the counter in the STOP mode while in counting up, return to preset value in other counting modes |

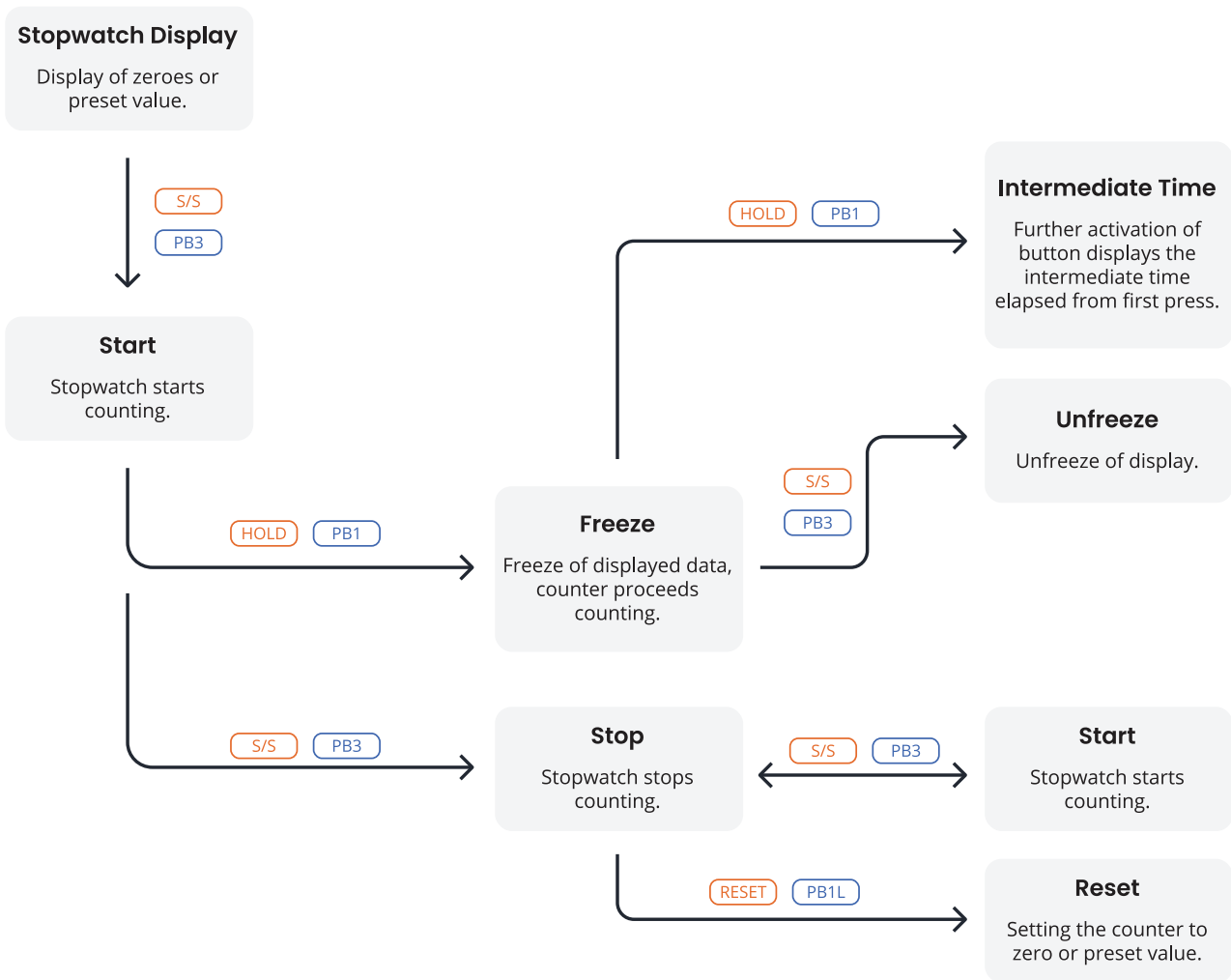

10.4.3. Control Mode 3

| Remote controller button | Push-button | Function |
|--------------------------|-------------|---|
| S/S | PB3 | Count up from zero or from preset value in countdown mode, next press of push-button causes the display to freeze and to resume the count from zero in counting up or from preset value in countdown mode |
| HOLD | PB1 | Unfreeze of display, leaving the counter continue in counting |
| RESET | PB1L | Counter reset to zero or return to preset value followed with counter stop |

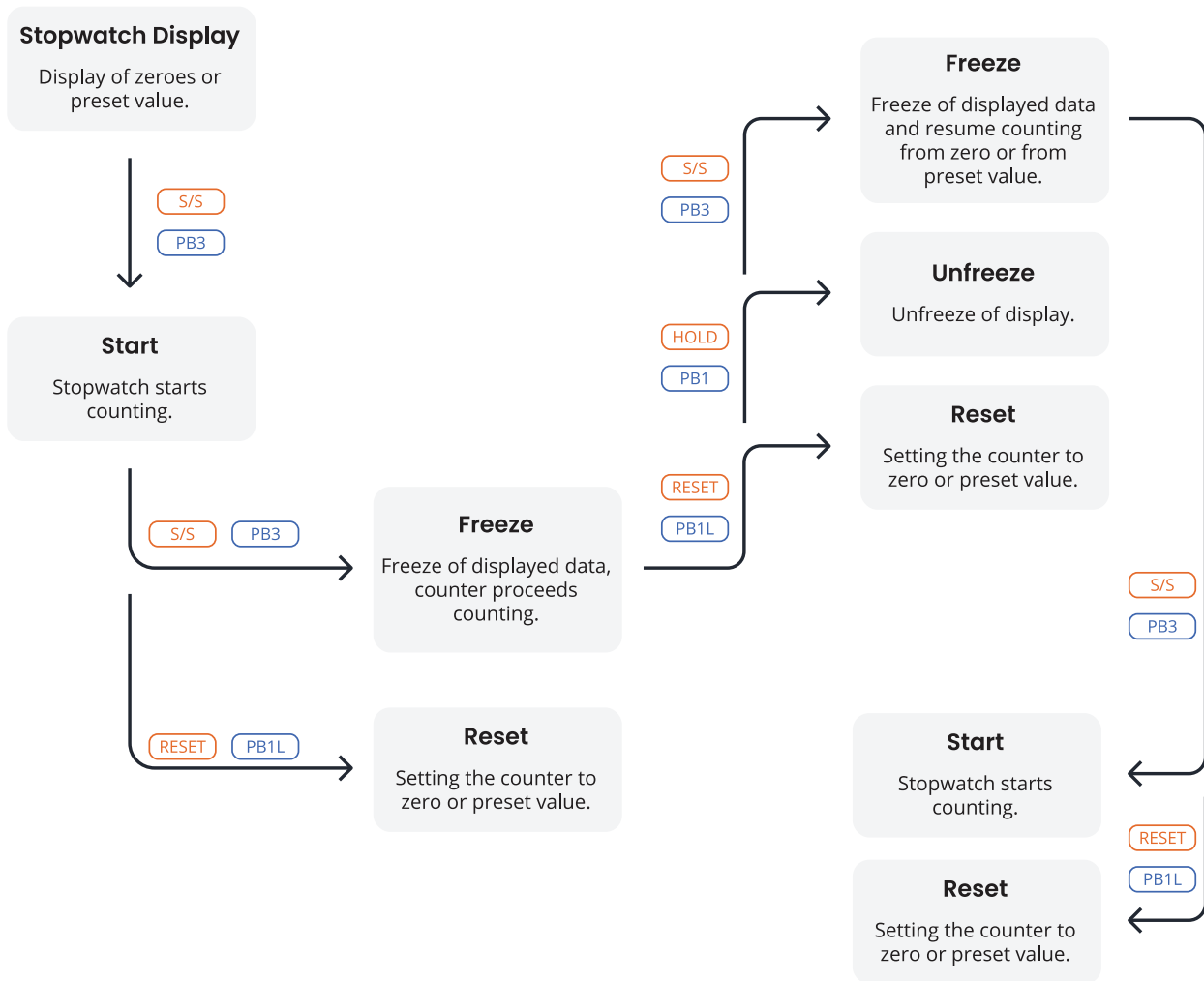

10.4.4. Control Mode 4

| Remote controller button | Push-button | Function |
|--------------------------|-------------|---|
| S/S | PB3 | Triggering the counter |
| HOLD | PB1 | Stopping the counter |
| RESET | PB1L | Resetting the counter or return to preset value with counter stop |

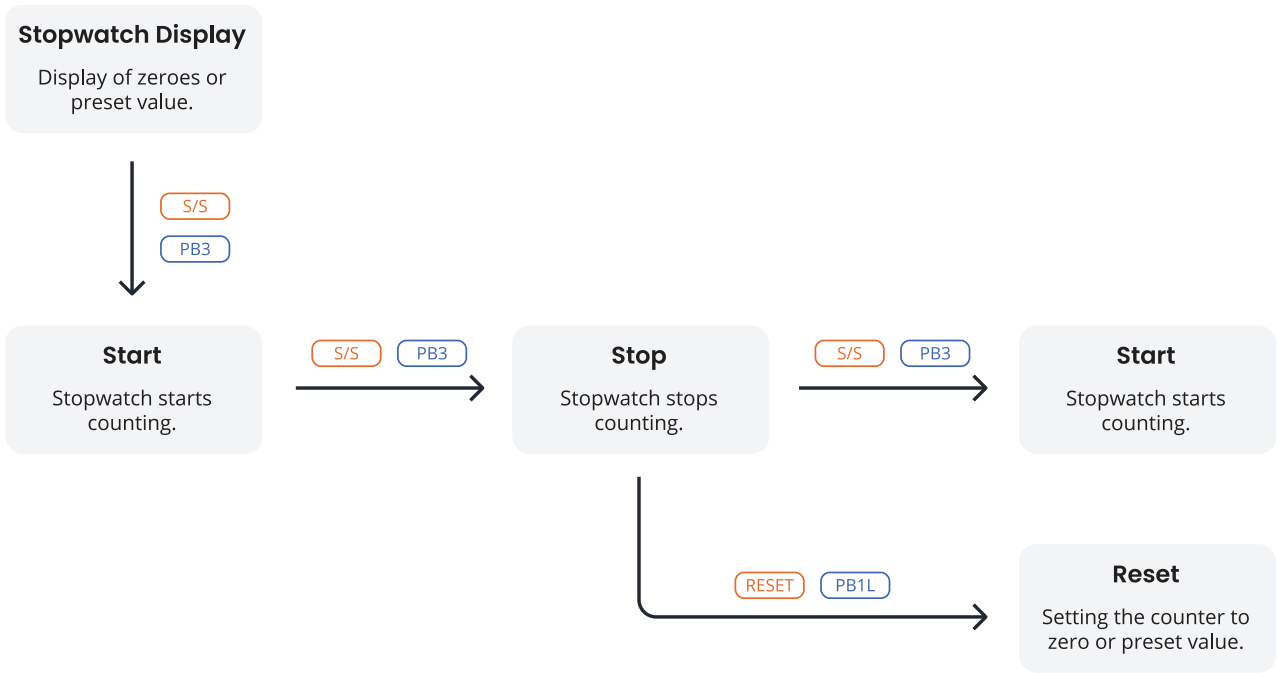

10.4.5. Control Mode 5

| Remote controller button | Push-button | Function |
|--------------------------|-------------|---|
| S/S | BRB10 | Alternately: 1. Start 2. Stop 3. Reset |

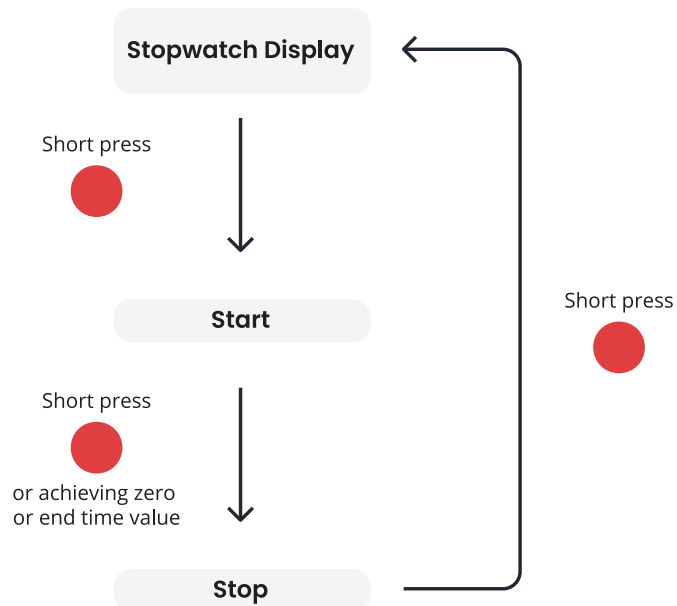

10.4.6. Control Mode 6

| Remote controller button | Push-button | Function |
|--------------------------|-------------|---|
| | | Alternately: 1. Stopwatch display + Start 2. Stop 3. Default display + Reset |

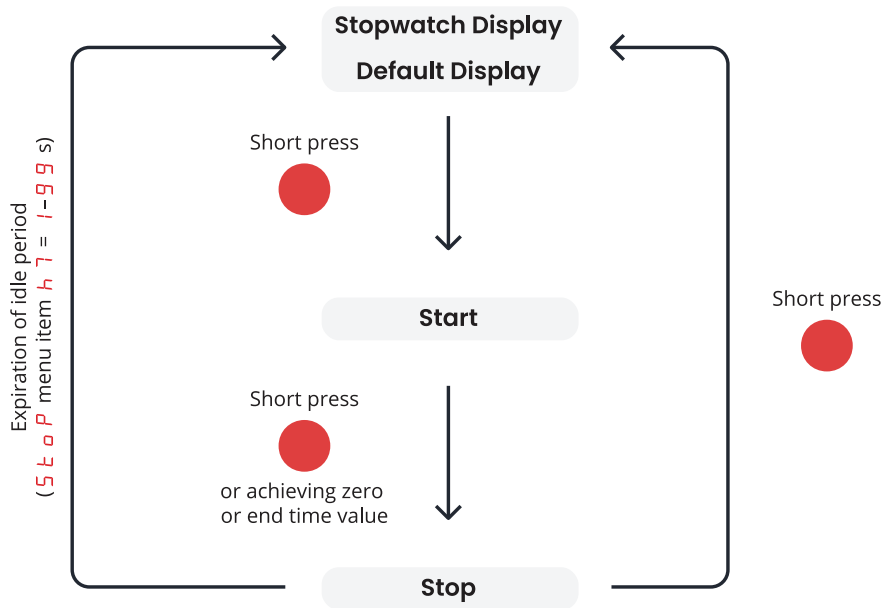

If the expiration of idle period (item **h 7**) is set to value **0** , the display will switch to default display **immediately** .

Default display can be set in the **d 15 P** menu item **d 3** (chapter Time Constants for Automatic Data Switching Over):

1. **Display OFF**

If the **d 15 P** menu item **d 3** is set to value **4** (continuous display of stopwatch), the display will switch OFF after the expiration of idle period or short press of button.



2. **Display Time, Date or Temperature**

If the **d 15 P** menu item **d 3** is set to value **0 , 1 , 2 , 3 , 5 , 6** or **U** , the display will switch to either Time, Date or Temperature display after a expiration of idle period or short press of button.

10.4.7. Control Mode 7

| Remote Controller Button | Push-button | Function |
|--------------------------|----------------------|---|
| | (press and hold) | After pressing and holding down the button or alternatively pressing the remote control button, the stopwatch will start counting |

| Remote Controller Button | Push-button | Function |
|--------------------------|-------------|---|
| | | After reaching zero or end time value, the stopwatch will stop counting If the menu item h 4 is set to value 1 - 30 or L , the relay contact will close |
| RESET | | After releasing the PB1 button or alternatively pressing the RESET remote control button, the stopwatch will reset, and the relay contact will open if closed |

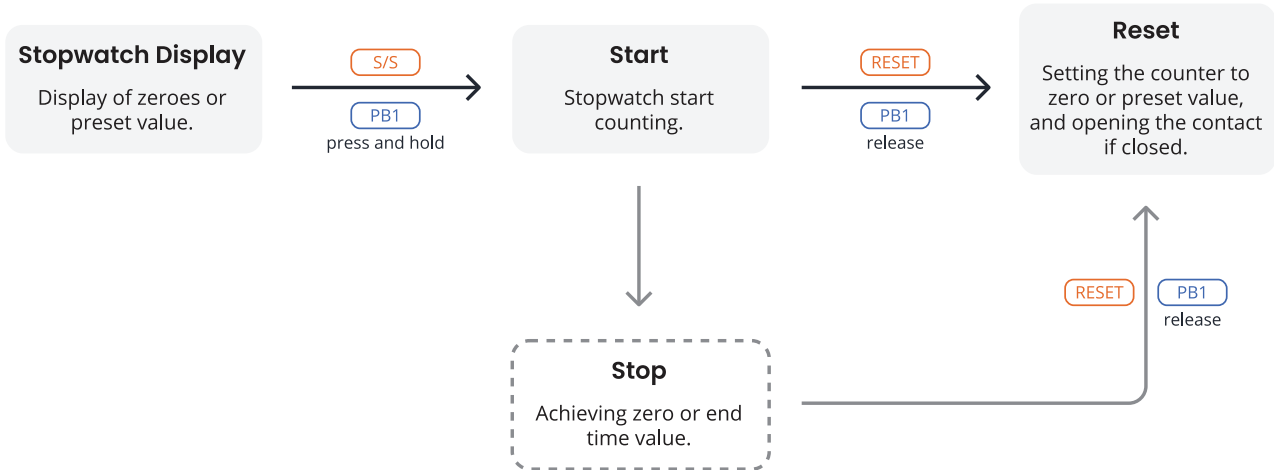

For easy control, you can connect any external contact (e.g. relay controlled by external device) to TEMP connector. For more information about connecting, see BRB10 Connection chapter.

10.4.8. Control Mode 8

| Signal | | Function |
|--------|--------------------|---|
| TEMP1 | <i>activated</i> | The stopwatch starts countdown 1 |
| | <i>deactivated</i> | The stopwatch stops countdown 1 (and countdown 2 if active) and switches to default display |
| TEMP2 | <i>activated</i> | The stopwatch starts countdown 2 (the signal on TEMP1 must be active) |
| | <i>deactivated</i> | - |



The stopwatch may or may not finish countdown 1 (display of **00:00**) in order to start countdown 2. As soon as the signal on TEMP2 is activated, the countdown 2 starts.
 If the signal on TEMP1 is deactivated, both countdowns stop and the default display is displayed.

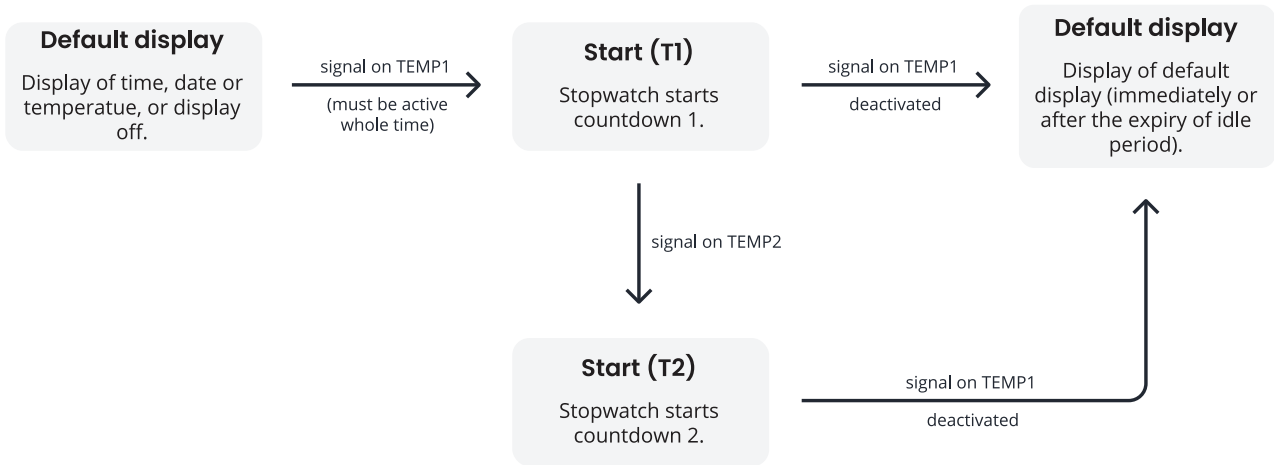

If the expiration of idle period (item **h 7**) is set to value **0** , the display will switch to default display **immediately** .

Default display can be set in the **d 1 5 P** menu item **d 3** (chapter Time Constants for Automatic Data Switching Over) :

1. **Display OFF**

If the **d 1 5 P** menu item **d 3** is set to value **4** (continuous display of stopwatch), the display will switch OFF after the expiration of idle period or short press of button.



2. **Display Time, Date or Temperature**

If the **d 1 5 P** menu item **d 3** is set to value **0 , 1 , 2 , 3 , 5 , 6** or **U** , the display will switch to either Time, Date or Temperature display after a expiration of idle period or short press of button.

10.4.9. Control Mode 9

| Signal | | Function |
|--------|--------------------|--|
| TEMP1 | <i>activated</i> | The stopwatch starts counting If the stopwatch reaches zero or the end-time value, it stops counting and waits for the signal to be deactivated |
| | <i>deactivated</i> | The stopwatch stops counting and switches to the default display, either immediately or after the idle period expires |

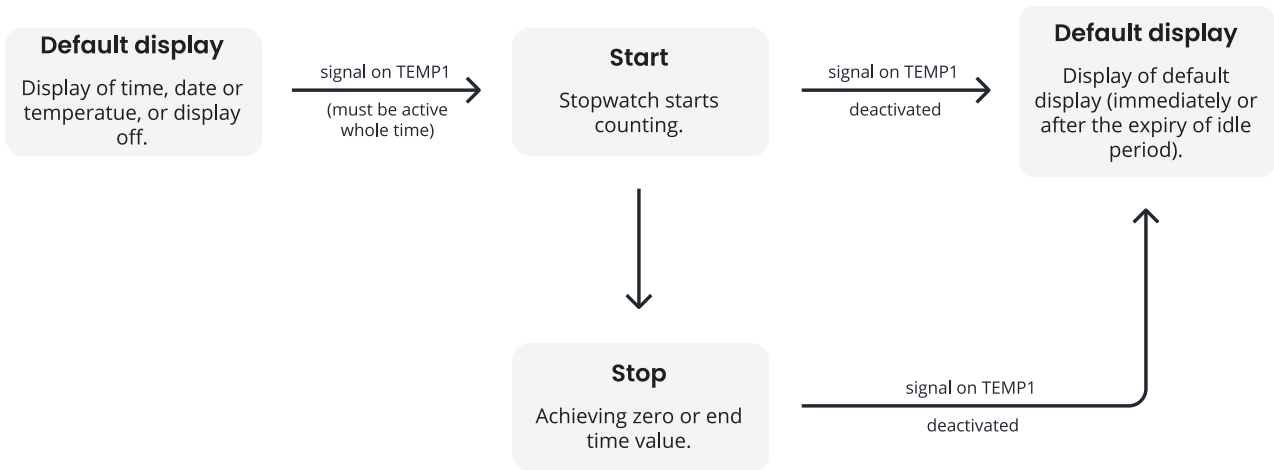

If the expiration of idle period (item **h 7**) is set to value **0** , the display will switch to default display **immediatly** .

Default display can be set in the **d 1 5 P** menu item **d 3** (chapter Time Constants for Automatic Data Switching Over):

1. **Display OFF**

If the **d 1 5 P** menu item **d 3** is set to value **4** (continuous display of stopwatch), the display will switch OFF after the expiration of idle period or short press of button.



2. **Display Time, Date or Temperature**

If the **d 1 5 P** menu item **d 3** is set to value **0 , 1 , 2 , 3 , 5 , 6** or **U** , the display will switch to either Time, Date or Temperature display after a expiration of idle period or short press of button.

10.5. Counting Unit

Navigation

Menu:

Item:

Available values:



1, 2, 3, 4

Description

The stopwatch counting unit determines how time is divided and displayed as the stopwatch runs. The counting unit vary depending on the stopwatch's design and purpose.

Available Settings

| Value | Description |
|-------------------|---|
| 1 (default value) | Counting in increments of 1/100 seconds (with 4-digit display the counting goes on until 59.99 seconds and then continues with displaying MM:SS. , and then HH:MM respectively) Up to 99 hours, 59 minutes and 59.990 seconds |
| 2 | Counting in increments of 1 second (with 4-digit display the counting goes on until 59 minutes and 59 seconds and then continues with displaying of HH:MM) Up to 99 hours, 59 minutes and 59 seconds |
| 3 | Counting in increments of 1 minute Up to 99 hours and 59 minutes |
| 4 | Counting in periods after one day subtraction or addition always takes place around midnight Up to 9999 days (when counting is stopped, the dot is displayed after the last digit) |

10.6. Contact Closing



This setting is available only with REL option.

Navigation

Menu:

Item:

Available values:

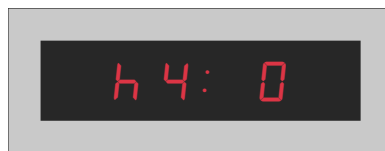

0, 1-30, C, L

Description

Stopwatch contact closing is a fundamental operation used in various applications where precise timing is required, such as in sports, scientific experiments, cooking, and many other field.

Available Settings

| Value | Description |
|-------------------|--|
| 0 (default value) | Function disabled |
| 1-30 | Time period of contact for stopwatches in seconds, passing through zero while operating in countdown mode or achieving end time in count-up mode, starting from preset value |
| C | Contact is closed during active counting |
| L | Contact closes after passing zero in countdown mode or upon reaching end time in count-up mode, and remains closed until stopwatch reset |

10.7. External Keyboard Connection

Navigation

Menu:

Item:

Available values:

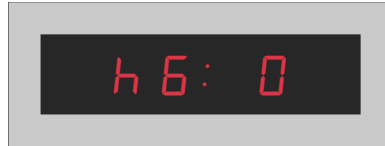

0, 1

Available Settings

| Value | Description |
|-------------------|-------------------|
| 0 (default value) | Function disabled |
| 1 | Connected |



If the external keyboard is connected, the TP3/30m and TPHP temperature sensors **cannot be connected**.

10.8. Timeout to Switch to Default Display for BRB

Navigation

Menu:

Item:

Available values:

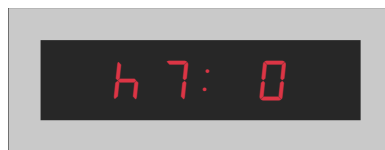

0, 1 - 99

Description

Here you can set the timeout to switch to default display after pressing the BRB10 button.

Available Settings

| Value | Description |
|-------------------|---|
| 0 (default value) | Function disabled |
| 1 - 99 | Time in seconds to go to the default display after stopping the stopwatch or reaching the target time |

10.9. BRB10 Connection

The BRB10 button is connected via the **NO** contact to the **TEMP** connector.

1. Connect **brown** cable into **-**.
2. Connect **black** cable into **T1**.

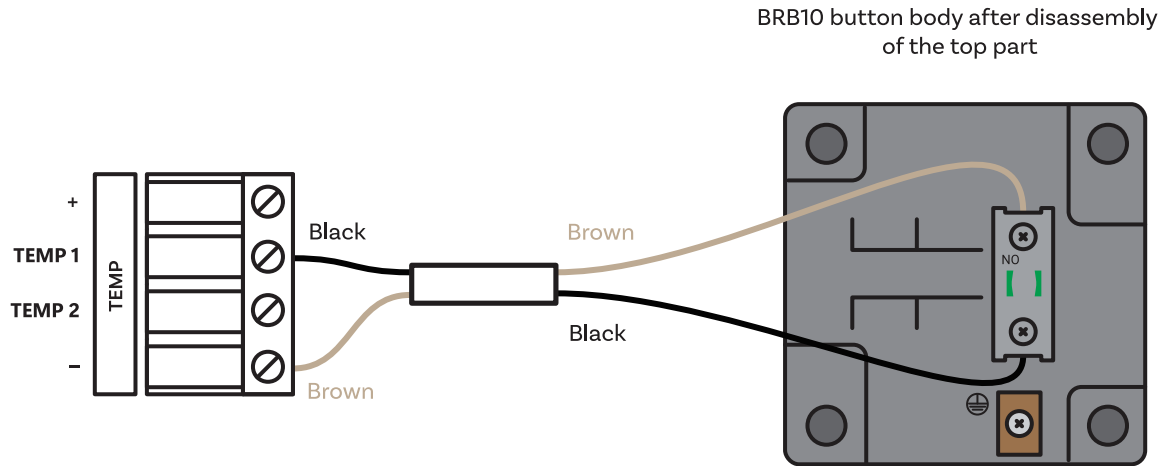

10.10. Stopwatch Start Time (2nd Input)

Navigation

Menu:

Item:

Available values:



submenu

Description



This setting is available only if stopwatch control mode is set to value **h 2: 8**.

This setting is for setting the stopwatch start time for downwards counting 2.

Submenu

Submenu for Setting the Stopwatch Start Time

| Displayed Item | Value(s) | Description | Range |
|----------------|----------|----------------|------------|
| HH : MM | HH | Hour setting | Range 0–99 |
| | MM | Minute setting | Range 0–59 |

| Displayed Item | Value(s) | Description | Range |
|----------------|----------|----------------------|------------|
| SS.HsHs | SS | Seconds setting | Range 0–59 |
| | HsHs | 1/100 second setting | Range 0–99 |

The available time settings depend on the selected counting unit (menu item **h 3**). According to the set counting unit, some fields are disabled and shown as dashes (- -).



- If **h 3:1** (1/100 second unit) is set: setting format **HH:MM** and **SS.HsHs** , maximum **99:59:59.990** .
- If **h 3:2** (second unit) is set: setting format **HH:MM** and **SS.--** , maximum **99:59:59.000** .
- If **h 3:3** (minute unit) is set: setting format **HH:MM** and **--.--** , maximum **99:59:00.000** .
- If **h 3:4** (day unit) is set: setting format **DD:DD** and **--.--** , maximum **9999** days.
Days are set as first two-digit field × 100 + second two-digit field.

10.11. External Button Input Active Level

These settings configure the active logic level of each external button input independently.

By default, an external button event is triggered by a logic low (LOG0) signal, corresponding to an active-low, contact-close input. Each input can be individually configured to operate in logic high (LOG1) mode, corresponding to an active-high, contact-open or permanent level signal.

This allows both external button inputs to operate simultaneously with different active levels (for example, input 1 active-high and input 2 active-low).

When an input is configured for active-high operation, it is treated as a level-based signal rather than an edge-triggered event. Button events from inputs configured as active-high are processed only on the stopwatch screen. During screen navigation and menu operation, these inputs are ignored to prevent unintended menu navigation caused by a permanent external signal.

10.11.1. External Button Input 1 Active Level

Navigation

Menu:



Item:

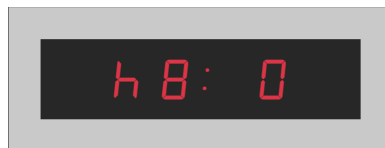

Available values:

0, 1

Available Settings

| Value | Description |
|-------------------|----------------------------|
| 0 (default value) | Input 1 active low (LOG0) |
| 1 | Input 1 active high (LOG1) |

10.11.2. External Button Input 2 Active Level

Navigation

Menu:

Item:

Available values:

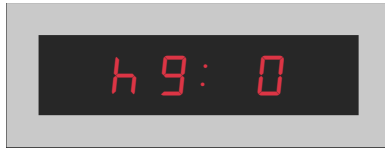

0, 1

Available Settings

| Value | Description |
|-------------------|----------------------------|
| 0 (default value) | Input 2 active low (LOG0) |
| 1 | Input 2 active high (LOG1) |

10.12. Display Blink

This function enables blinking of the stopwatch display while the stopwatch is running.

10.12.1. Blinking Enable

Navigation

Menu:

Item:

Available values:

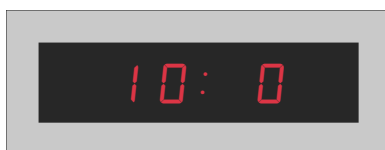
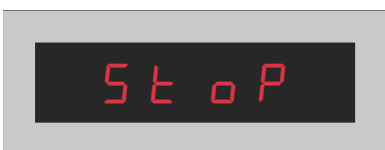

0, 1

Description

When display blink is enabled, the stopwatch display periodically turns off and on during time counting. This provides a clear visual indication that the stopwatch is active and time measurement is in progress.

When display blink is disabled, the display remains continuously visible during stopwatch operation.

Enabling this function adds additional configuration pages for setting the blink period and duty cycle. These configuration pages are hidden when display blink is disabled.

Available Settings

| Value | Description |
|-------------------|-------------|
| 0 (default value) | Disabled |

| Value | Description |
|-------|-------------|
| 1 | Enabled |

10.12.2. Blink Period

Navigation

Menu:

Item:

Available values:

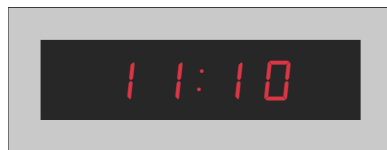

5 - 50

Description

Defines the duration of one complete blinking cycle (ON + OFF).

Available Settings

| Value | Description |
|--------|--|
| 5 - 50 | Total blink cycle duration Unit: 0.1 s Default: 10 (1.0 s) |

10.12.3. Blink Duty

Navigation

Menu:

Item:

Available values:

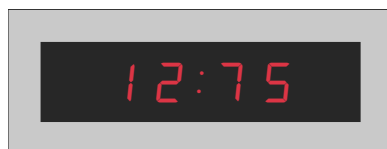
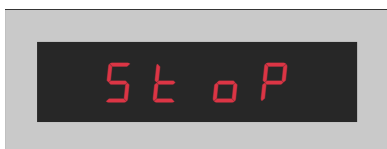

10 - 90

Description

Specifies the proportion of time during which the display is visible within one blinking cycle.

Available Settings

| Value | Description |
|---------|--|
| 10 - 90 | Fraction of period during which display is visible Unit: % Default: 75 % |



Period 10 (1000 ms), duty 75 % → display ON 750 ms, display OFF 250 ms

10.13. Code Blue

10.13.1. Connection

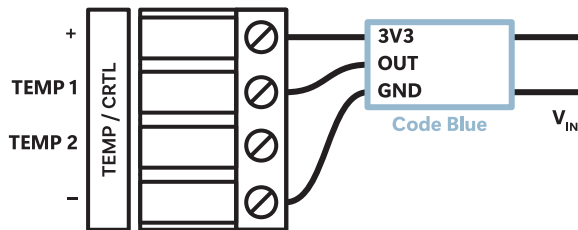

10.13.2. Recommended Settings

| Menu Item | Value | Description |
|-----------|---------|---|
| h 2 | 9 | Control mode 9 |
| h 6 | 1 | External keyboard connected |
| h 7 | 3 | Timeout to switch to default display set to 3 sec (recommended) |
| h 8 | 1 | Input 1 active high (LOG1) |
| i 0 | 1 | Display blink enabled |
| i 1 | 5 - 50 | Blink period as needed |
| i 2 | 10 - 90 | Blink duty as needed |

11 Time & Date Settings



Use these settings solely for autonomous mode or when utilizing an impulse line.

The display shows following:



Enter digital clock's main menu and navigate to **LINE** submenu. Enter by pressing the **PB2L** push-button or the **OK** button on the remote controller.

Time & Date Settings Summary

| Menu Item | Description | Value(s) |
|-----------|--------------|----------|
| HH:MM | Time Setting | * |
| DD.MM. | Date Setting | * |
| 20YY | Year Setting | * |

Values with * have an accessible submenu, e.g., **IP** *.

11.1. Time

Navigation

Menu:

Item:

Available values:

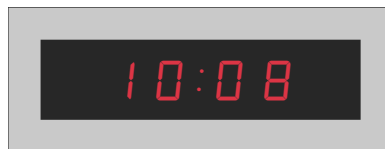
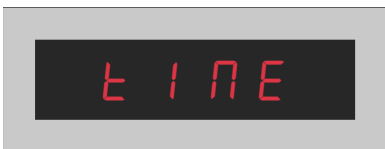

submenu

Description

Here you can set-up displayed time.

Available Settings

Submenu for Setting Time

| Value | Description | Range |
|-------|--------------------|------------|
| HH | Setting of hour | Range 0–23 |
| MM | Setting of minutes | Range 0–59 |

11.2. Date and Year

11.2.1. Date

Navigation

Menu:

Item:

Available values:

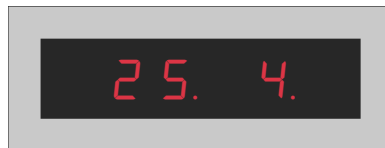
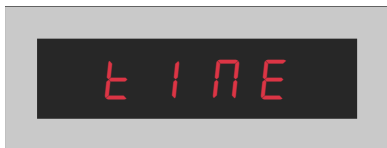

submenu

11.2.2. Year

Navigation

Menu:

Item:

Available values:



submenu

Description

Here you can set-up displayed date and year.

Submenu

Submenu for Setting Date (and Year)

| Value | Description | Range |
|-------|------------------|------------|
| DD | Setting of day | Range 1–31 |
| MM | Setting of month | Range 1–12 |

| Value | Description | Range |
|-------|-----------------|------------|
| YY | Setting of year | Range 0-99 |



If the set date is out of valid range while saving the set year, it will be automatically corrected. The menu will not be saved, it will return back to the beginning of setting the day and it is necessary to go through the entire setting menu again to confirm or modify the suggested date changes.

12 Power modes

✔ Added in version r7.14.

The display shows following:



Enter digital clock’s main menu and navigate to *P o u r* submenu. Enter by pressing the **PB2L** push-button or the **OK** button on the remote controller.

The digital clock supports power OFF and power SAVE modes. These are modes where the clock display is turned off to ensure lower power consumption.

Power Modes Summary

| Menu Item | Description | Value(s) |
|------------|----------------------|--------------|
| <i>P 1</i> | Power OFF | <i>0 , 1</i> |
| <i>P 2</i> | Power SAVE | <i>0 , 1</i> |
| <i>P 3</i> | SAVE Mode Start Time | <i>5 6 *</i> |
| <i>P 4</i> | SAVE Mode End Time | <i>E d *</i> |

Values with * have an accessible submenu, e.g., *1 P **.

12.1. Power OFF

Navigation

Menu:

Item:

Available values:



0 , 1

Description

This mode ensures that the clock display is permanently off. The clock does not respond to any press of remote controller buttons or push-buttons.

Available Settings

| Value(s) | Description |
|----------|--|
| 0 | No function |
| 1 | Immediate switching off of the clock display |

Alternatively for IR remote controller , activation of power off mode can be done by long pressing the **DISP** from **Main screens** (display of time, date, stopwatch, ...).

After confirmation, the display will immediately switch to Power OFF mode and turns off. Entry into this mode is indicated by displaying **OFF** for 1 second.



The mode is exited by long pressing the **DISP** button on the IR remote controller or by long pressing **PB1** or **PB2** . The display is then switched on again.

Alternatively, activation can be done via Web interface – Mode Tab .

- Overview
- Network
- Time
- Time zone
- Mode
- Sensors
- Supervision
- General
- Command
- Authentication
- Manual
- Logout

Calendar week

Temperature 1

Humidity 1

Pressure 1

Temperature 2

Humidity 2

Pressure 2

Power

Power OFF

Power save mode

Save mode start

Save mode end

Shared mode

Multicast sharing port

Display mode sharing

Stopwatch sharing

Relay sharing

Brightness sharing

Screen sharing

Sensor 1 sharing

Sensor 2 sharing

12.2. Power SAVE

Navigation

Menu:

Item:

Available values:

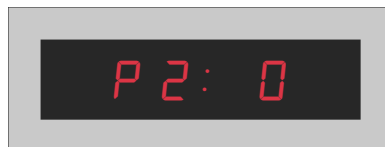
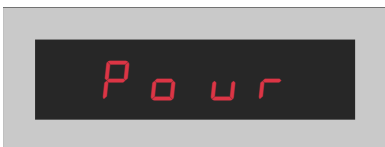

0, 1

Description

An automatic mode where the clock display is switched off at set time interval. If one of the push-buttons or the IR remote controller is pressed, the display is briefly switched on. At this time the clock can be operated normally.

After 10 seconds have elapsed since the last press of the button or push-button, the clock display will switch off again.

Entry into this mode is indicated by the display of **S L P** for 1 second .



Available Settings

| Value(s) | Description |
|----------|--------------------------|
| 0 | Power save mode disabled |
| 1 | Power save mode enabled |

Alternatively, activation can be done via Web interface – Mode Tab .

- Overview
- Network
- Time
- Time zone
- Mode
- Sensors
- Supervision
- General
- Command
- Authentication
- Manual
- Logout

Calendar week

Temperature 1

Humidity 1

Pressure 1

Temperature 2

Humidity 2

Pressure 2

Power

Power OFF

Power save mode

Save mode start

Save mode end

Shared mode

Multicast sharing port

Display mode sharing

Stopwatch sharing

Relay sharing

Brightness sharing

Screen sharing

Sensor 1 sharing

Sensor 2 sharing



Following start and end time submenus are accessible only if the Power save mode is activated.

12.2.1. SAVE Mode Start Time

Navigation

Menu:

Item:

Available values:

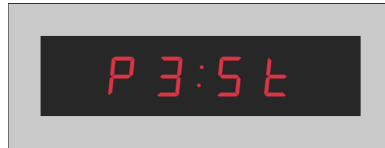

5 t (submenu)

Submenu

The Save mode start time can be set by this submenu:

| Value(s) | Description | Range |
|----------|--------------------|------------|
| HH | Setting of hour | Range 0–23 |
| MM | Setting of minutes | Range 0–59 |

12.2.2. SAVE Mode End Time

Navigation

Menu:

Item:

Available values:

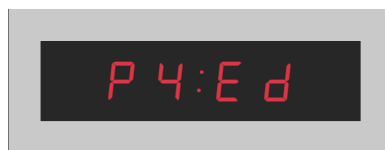

E d (submenu)

Submenu

The Save mode end time can be set by this submenu:

| Value(s) | Description | Range |
|----------|--------------------|------------|
| HH | Setting of hour | Range 0–23 |
| MM | Setting of minutes | Range 0–59 |

13 Share Mode

✔ Added in version r8.0.



Available only for digital clock synchronized by Ethernet variant and/or with RS-485 option.

The display shows following:



Enter digital clock’s main menu and navigate to *S h r E* submenu. Enter by pressing the **PB2L** push-button or the **OK** button on the remote controller.

The sharing mode allows sharing of certain parameters, values and functions between multiple devices. It is assumed that for each shared parameter, there is one Master device and several Slave devices. The Master device sends the shared values, and Slave devices receive and apply them.

Currently, the following parameters can be shared:

- Display Mode
- Stopwatch
- Relay
- Brightness
- Screen
- Sensor
- Time



For an individual parameter, there must not be more than one control device on the common shared channel (UDP port or RS485). Otherwise, the subordinate clocks will display incorrect information or it may lead to erroneous behavior.

Share Mode Settings Summary

| Menu Item | Description | Value(s) |
|------------|---|------------------|
| <i>E 0</i> | Interface Setting | <i>0 , 1</i> |
| <i>E 1</i> | UDP Port Setting | <i>P E *</i> |
| <i>E 2</i> | Sharing Display Mode (Default Display, Stopwatch) | <i>0 , 1 , 2</i> |
| <i>E 3</i> | Sharing Stopwatch | <i>0 , 1 , 2</i> |
| <i>E 4</i> | Sharing Relay | <i>0 , 1 , 2</i> |
| <i>E 5</i> | Sharing Display Brightness | <i>0 , 1 , 2</i> |
| <i>E 6</i> | Sharing Screen | <i>0 , 1 , 2</i> |
| <i>E 7</i> | Sharing Time | <i>0 , 1 , 2</i> |

| Menu Item | Description | Value(s) |
|-----------|-------------------------|----------|
| 10 | Sharing Sensor 1 | 0, 1, 2 |
| 11 | Sharing Sensor 2 | 0, 1, 2 |
| 20 | Local Stopwatch Setting | 0, 1 |

Values with * have an accessible submenu, e.g., 1P*.

13.1. Interface Setting



This setting is available only if the digital clock is Ethernet variant and also include RS-485 option.

Navigation

Menu:

Item:

Available values:



0, 1

Description

Setting of the interface through which sharing will take place.

Available Settings

| Value | Description |
|-------|-------------|
| 0 | LAN |
| 1 | RS-485 |

13.2. UDP Port Setting

Navigation

Menu:

Item:

Available values:

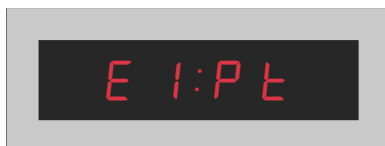

Pt (submenu)

Description



Available only if the clocks include Ethernet and LAN interface for sharing is selected (the *S h r E* menu item *E 0* is set to value *0* (see Interface Setting chapter)).

To set the UDP port value, enter the Submenu *P t* and set your desired UDP port by following items

The UDP port is set in format *xyyy*, range: *1* - *65535*. The default port is *65533*.

Submenu

Submenu *P t* for setting the UDP port

| Value | Description | Range |
|---------------------------|-----------------------------|---|
| <i>a</i> <i>[x][x]</i> | UDP Port, thousands setting | <ul style="list-style-type: none"> First digit: <i>0</i> - <i>6</i> Second digit: <i>0</i> - <i>9</i> |
| <i>b</i> <i>[y][y][y]</i> | UDP Port, units setting | <ul style="list-style-type: none"> All digits: <i>0</i> - <i>9</i> |



You cannot select a port currently used by another service. By default, ports *65532* and *65534* are occupied.

13.3. Sharing Display Mode (Default Display, Stopwatch)

Navigation

Menu:

Item:

Available values:

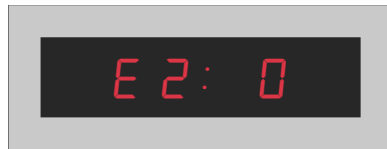

0, 1, 2

Description

Sharing information on whether to display the main screen (time, date, etc.) or the stopwatch.

Available Settings

| Value | Description |
|----------|-------------|
| <i>0</i> | Disabled |
| <i>1</i> | Master |
| <i>2</i> | Slave |

13.4. Sharing Stopwatch

Navigation

Menu:

Item:

Available values:

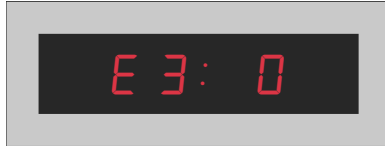

0, 1, 2

Description

Sharing the stopwatch along with its mode and settings (counting direction, start value, etc.).



In order to display the correct stopwatch value, the Slave clock **must be synchronized**.

If the Slave clocks need to have different stopwatch settings, set the *S h r E* menu item *2 0* to value *1* (see Local Stopwatch Setting chapter).

Available Settings

| Value | Description |
|-------|-------------|
| 0 | Disabled |
| 1 | Master |
| 2 | Slave |

13.5. Sharing Relay

Navigation

Menu:

Item:

Available values:

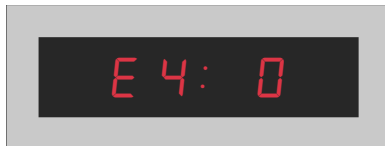

0, 1, 2

Description

Sharing the relay status (the Slave clock may not be equipped with REL option, but its virtual status can be shared).

Available Settings

| Value | Description |
|-------|-------------|
| 0 | Disabled |

| Value | Description |
|-------|-------------|
| 1 | Master |
| 2 | Slave |

13.6. Sharing Display Brightness

Navigation

Menu:

Item:

Available values:

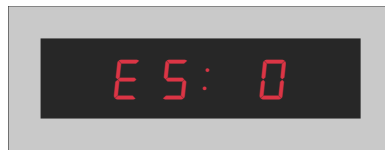

0, 1, 2

Description

Sharing the set display brightness.

The desired display brightness can be set in the *dISP* menu item *d!* (see Display Brightness chapter).

Available Settings

| Value | Description |
|-------|-------------|
| 0 | Disabled |
| 1 | Master |
| 2 | Slave |

13.7. Sharing Screen

Navigation

Menu:

Item:

Available values:

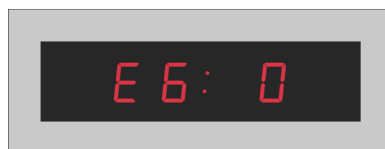

0, 1, 2

Description

Direct screen sharing. Menu navigation and similar actions are also shared.

Available Settings

| Value | Description |
|-------|-------------|
| 0 | Disabled |
| 1 | Master |
| 2 | Slave |

13.8. Sharing Time

Navigation

Menu:

Item:

Available values:



0, 1, 2

Description



Available only for RS-485 Interface (the *ShrE* menu item *E0* is set to value *1* (see Interface Setting chapter)).

Sharing time from Master clock to Slave clock.

In the Slave clocks, synchronization to this shared parameter can then be set in the *SYN* menu item *o2* set to value *12* (see Type of Synchronization chapter). Although it may not be as precise as direct synchronization from other sources.

Available Settings

| Value | Description |
|-------|-------------|
| 0 | Disabled |
| 1 | Master |
| 2 | Slave |

13.9. Sharing Sensor 1

Navigation

Menu:

Item:

Available values:



0, 1, 2

Description

Sharing values measured by sensor 1. In the Slave clocks, a virtual shared sensor 1 can then be set as sensor type in the **SEN1** menu item **E1** (see Sensor Type chapter).

Available Settings

| Value | Description |
|-------|-------------|
| 0 | Disabled |
| 1 | Master |
| 2 | Slave |

13.10. Sharing Sensor 2

Navigation

Menu:

Item:

Available values:



0, 1, 2

Description

Sharing values measured by sensor 2. In the Slave clocks, a virtual shared sensor 2 can then be set as sensor type in the **SEN2** menu item **E1** (see Sensor Type chapter).

Available Settings

| Value | Description |
|-------|-------------|
| 0 | Disabled |
| 1 | Master |
| 2 | Slave |

13.11. Local Stopwatch Setting

Navigation

Menu:

Item:

Available values:

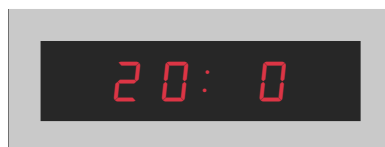

0, 1

Description

If this settings is disabled, the Slave clocks will not share stopwatch settings with Master clock.

Available Settings

| Value | Description |
|-------|-------------|
| 0 | Disabled |
| 1 | Enabled |

13.12. Examples of Share Mode Settings

Sharing Stopwatch and Relays over LAN with Automatic Transition to Stopwatch

Connection Description

- Multiple clocks synchronized by NTP protocol (NTP / PoE / WiFi variant) connected to a common network.
- One Master clock with BRB10 connected, the rest Slave clocks with sirens connected to their relays.
- Source of synchronization of all clocks NTP server (e.g. pool.ntp.org)
- Default display of Time, when BRB is presed, transition to Stopwatch display and starting the countdown of 5 minutes, relay on

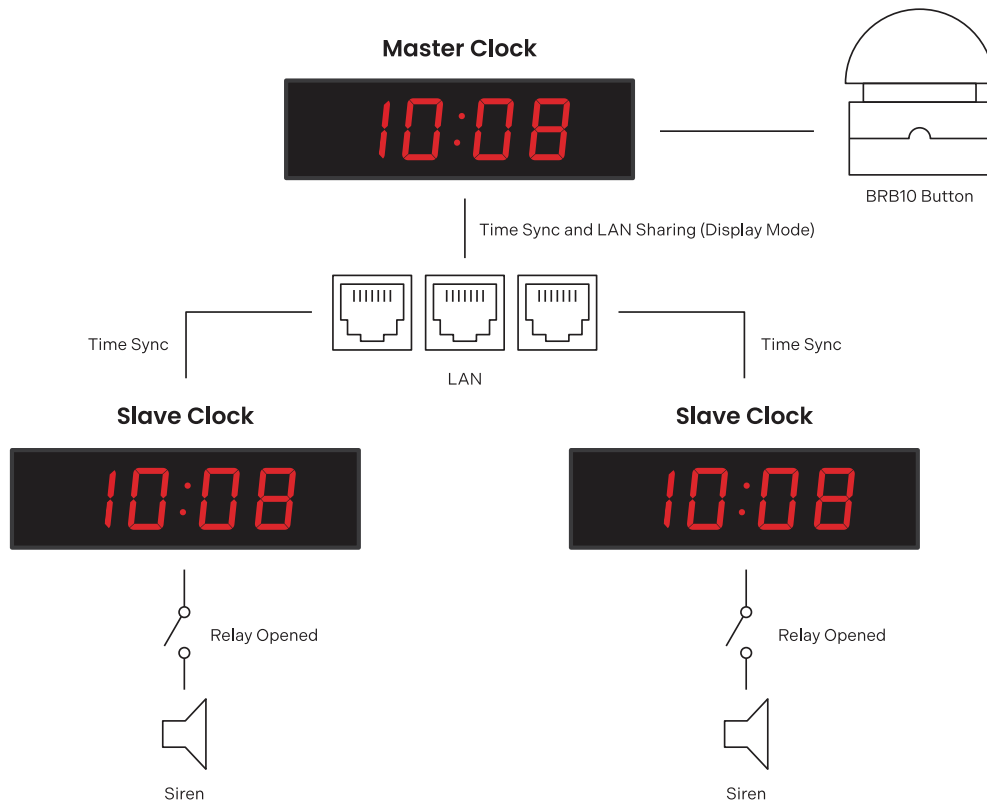

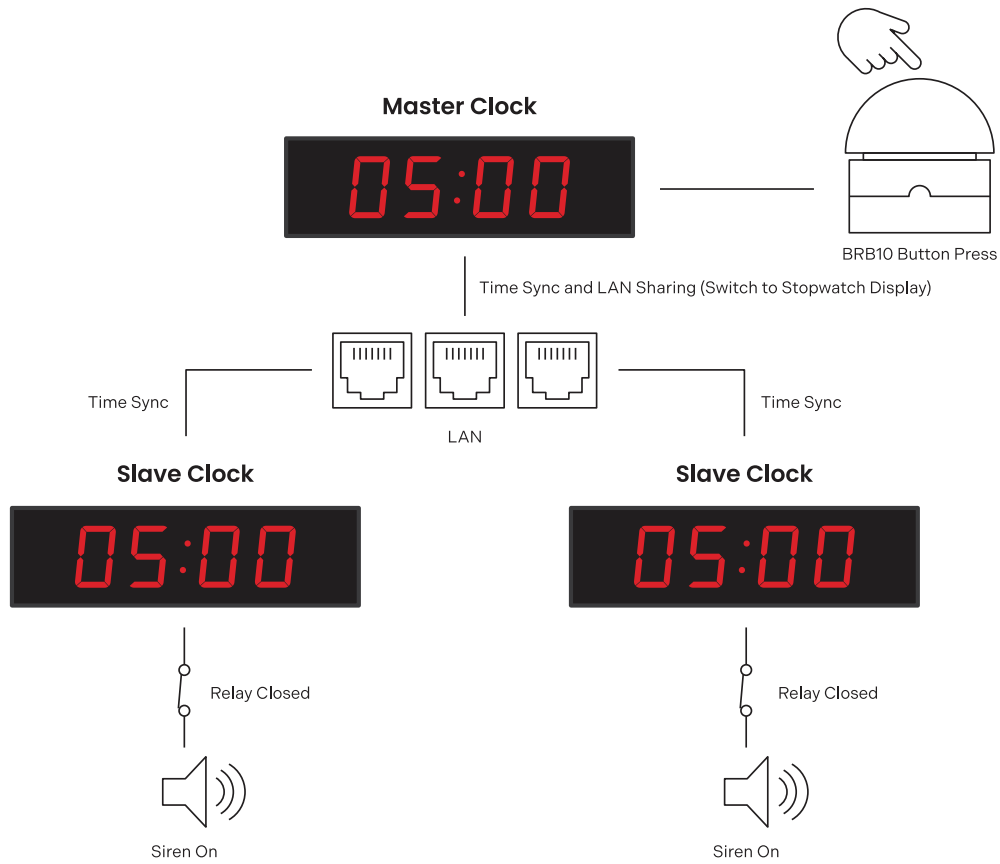

Master Clock Settings

Sharing Settings

| Setting | Menu | Item | Value |
|--------------------------------|------|------|-------|
| Sharing Display Mode as Master | ShrE | E2 | 1 |
| Sharing Stopwatch as Master | ShrE | E3 | 1 |
| Sharing Relay as Master | ShrE | E4 | 1 |

Other Settings

| Setting | Menu | Item | Value |
|--|------|------|-------|
| Stopwatch in Countdown Mode | StoP | h1 | 2 |
| Stopwatch Countdown Period 5 min | StoP | PrES | 00:05 |
| Relay Disconnect on Countdown (this setting is also available for variant without Relay option if Sharing Relay option is enabled in Master mode) | StoP | h4 | 0 |
| External Keyboard Connection | StoP | h6 | 1 |
| BRB10 Control Mode | StoP | h2 | 6 |

Slave Clock Settings

Sharing Settings

| Setting | Menu | Item | Value |
|-------------------------------|---------|------|-------|
| Sharing Display Mode as Slave | S h r E | E 2 | 2 |
| Sharing Stopwatch as Slave | S h r E | E 3 | 2 |
| Sharing Relay as Slave | S h r E | E 4 | 2 |



For Sharing Stopwatch to work properly, all clocks must be synchronized (NTP server in this example), otherwise the slave clock will display - : - : - .

Sharing Time and Temperature via RS-485 from a Clock Synchronized by GPS Variant

Connection Description

- One clock synchronized by GPS variant with RS-485 option with two TP3/30 temperature sensors, other clocks synchronized by LGC variant with RS-485 option.
- GPS variant synchronized clock as Master clock with time and temperature measurement sharing on RS-485, other clocks as Slave clocks.
- Synchronization source:
 - Master: GPS
 - Slave: RS-485
- All clocks in automatic time, date and temperature display mode.

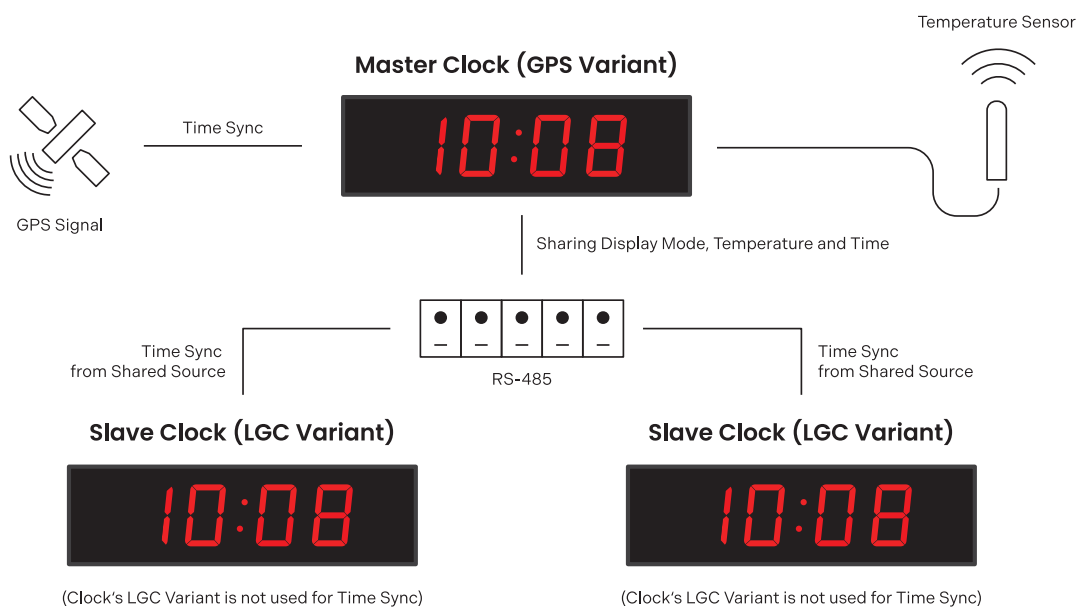

Master Clock Settings

Sharing Settings

| Setting | Menu | Item | Value |
|--------------------------------|---------|------|-------|
| Sharing Display Mode as Master | S h r E | E 2 | 1 |
| Sharing Time as Master | S h r E | E 7 | 1 |
| Sharing Sensor 1 as Master | S h r E | 1 0 | 1 |

Slave Clock Settings

Sharing Settings

| Setting | Menu | Item | Value |
|-------------------------------|---------|------|-------|
| Sharing Display Mode as Slave | S h r E | E 2 | 2 |
| Sharing Time as Slave | S h r E | E 7 | 2 |
| Sharing Sensor 1 as Slave | S h r E | 1 0 | 2 |

Other Settings

| Setting | Menu | Item | Value |
|---|---------|------|-------|
| Time Synchronization According to Master Clock (this setting takes the synchronized time from Master clock synchronized by GPS variant instead of being synchronized by its LGC variant) | S Y N C | 0 2 | 1 2 |
| Setting the Sensor Type to Shared Sensor | S E N - | E 1 | 1 3 |

14 System Settings

The display shows following:



Enter digital clock's main menu and navigate to **545t** submenu. Enter by pressing the **PB2L** push-button or the **OK** button on the remote controller.

System Settings Summary

| Menu Item | Description | Value(s) |
|------------|--|---|
| c 0 | Diagnostic tools | 1* , 2* , 3* , 4* , 5* , 6* , 7* , 8* |
| c 1 | Factory Reset | 0* , 1 |
| c 2 | Firmware Update via USB Process Settings | 0* , 1* |
| c 3 | Clock Address for IR Remote Controller (New since version r 7.15) | 1 - 99 |
| c 4 | IR Remote Controller Auto-Lock (New since version r 7.15) | 1 - 60 , U |
| c 5 | Display Brightness Derating | 0 , -1 , -2 , -3 , -4 , -5 |
| c 6 | Light Sensor Correction | 5 , 4 , 3 , 2 , 1 , 0 , -1 , -2 , -3 , -4 , -5 |
| c 7 | Individual Digit Brightness Setting (New since version r 8.02) | d , 1* |
| c 8 | Individual Dot Brightness Setting (New since version r 8.02) | d o* |

Default values are indicated with *, e.g., **1***.

Values with * have an accessible submenu, e.g., **1P***.



The menu items indicated by **red line** may not be available to all users. Its availability can vary depending on device configuration.

The menu items may be available for all users in future versions.

14.1. Diagnostic tools

Navigation

Menu:

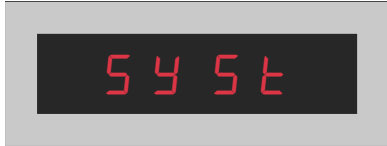

Item:

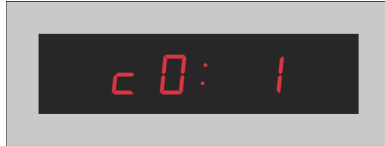

Available values:

0, 1, 2, 3, 4, 5, 6, 7, 8

Description

Diagnostic tools are set of specialized features and tools that allow you to monitor clock's functions.

Available tools

| Value(s) | Description |
|---------------------|-------------------------------------|
| 1 * (default value) | Display test |
| 2 * | Display of active alarms |
| 3 * | Display of internal temperature |
| 4 * | Display of test results |
| 5 * | Display of calibration deviation |
| 6 * | Passive DCF diagnostic menu |
| 7 * | Display of line quality diagnostics |
| 8 * | GPS diagnostic menu |

All values have accessible submenu.



14.1.1. Display Test Submenu

After entering this item, all segments of the display will light up.

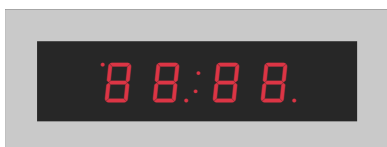
The display shows following:



14.1.2. Active Alarms Submenu

| Value(s) | Description |
|----------|---|
| AL: - - | If any alarm is not active |
| AL: xx | xx represents active alarm bit: |
| 0 | Synchronization lost in last one hour |
| 6 | Device restart |
| 7 | NMS communication error |
| 8 | Time zone error (season server) |
| 9 | NMS authentication error |
| 3 3 * | Empty calibration value (not calibrated) |
| 3 4 * | Synchronization timeout |
| 3 5 * | Not tested (test not passed) |
| 3 6 * | SSL certificates not present |
| 3 9 * | Hardware error – some module or peripheral is not present |
| | To browse between active bits, use  or  . |
| | Alarm bits with * are indicated by state LED. |

14.1.3. Internal Temperature Submenu

| Value(s) | Description |
|----------|--|
| dd °C | dd represents internal temperature in °C Example: 25 °C |

14.1.4. Test Results Submenu

| Value(s) | Description |
|----------|---|
| PASS | Tested in production with pass result |
| FAIL | Tested in production with failed result |
| Not | Not tested in production |

14.1.5. Calibration Deviation Submenu

| Value(s) | Description |
|-----------|---|
| - - - - | Calibration deviation greater than 1000 ppm |
| ▢ - - - | Calibration deviation greater than 100 ppm |
| - - . - - | Calibration deviation less than 100 ppm |

Negative deviation is indicated by a lit dot at the first digit.
 Currently running calibration is indicated by a flashing decimal point.

14.1.6. Passive DCF diagnostic menu



xx:yz – display during the minute, i.e. when receiving bits

| Value(s) | Description |
|----------|---|
| xx | Number of bits received in the current minute, ideally the counter corresponds to the current seconds value (range 0–58) |
| y | Value of the last received bit (value 0 or 1) |
| z | The number of consecutive telegrams received with time that were decoded without error Range 0–9, value greater than 9 is then displayed with a decimal point, i.e. 9. |

At one full minute (or if there is a pause between incoming bits of approx. 2 seconds), i.e. it is assumed that the whole telegram is received, a screen is displayed which shows the result of the telegram processing:

| Value(s) | Description | |
|-----------|--|---|
| --:z | Indicates successful processing of the DCF telegram, when z indicates the current value of the counter of consecutive received telegrams | |
| E r : d d | Value dd corresponds to the possible states listed below: | |
| | 0x01 | incorrect number of received bits |
| | 0x02 | missing start bit for the beginning of the telegram |
| | 0x04 | missing start bit for time reception |
| | 0x08 | parity error when decoding the minutes value |
| | 0x10 | parity error when decoding the hours value |
| | 0x20 | parity error in date decoding |
| | 0x40 | invalid decoded time range |
| | 0x80 | invalid decoded date range |

14.1.7. Line quality diagnostics submenu

The individual parameters are displayed as submenu items. You can browse between individual parameters by pressing the  or .

| Value(s) | Description | |
|----------|--|--|
| 5 c | detected synchronization signal source type submenu | |
| | 5 c :- | the synchronization source is not yet identified when auto is selected |
| | 5 c : xx | value xx indicates the type of the identified link, the displayed value corresponds to the description of the SYNC menu item o2 (Type of synchronization) |
| u | detected synchronization signal quality submenu | |
| | u - | the synchronisation signal is not yet correctly detected |
| | u xxx | value xxx corresponds to the percentage of the synchronization signal processing quality |
| E r | number of synchronization signal processing errors submenu | |
| | E r : xx | value xx in range 0–99 |
| | E r : 9 9. | counter value is greater than 99 |
| t | countdown of the time limit in seconds for restarting the synchronization signal detection process submenu | |
| | t xxx | value xxx in range 0–999 |
| | t 9 9 9. | counter value is greater than 999 |
| | With successful signal processing, the countdown never reaches zero | |
| 5 t | synchronization signal processing status submenu | |
| | 5 t : xx | value xx corresponds to the possible states: |
| | 0 | unknown |
| | 1 | line detected |
| | 2 | line frame detected |
| | 3 | line frame checked |
| | 4 | line time detected |
| | 5 | time zone detected |

14.1.8. GPS Diagnostic Submenu

| Value(s) | Description |
|----------|-------------|
| 5 t | GPS status |

| Value(s) | Description | |
|----------|---|--|
| | EE | GPS module error. Not present or not communicating. |
| | - | GPS not detected |
| | 2d | 2D Fix – GPS detected in 2D mode |
| | 3d | 3D Fix – GPS detected in 3D mode |
| Su | Number of satellites used to calculate position | |
| SA | Number of available satellites | |
| PP | Position Determination Accuracy (PDOP) | |
| | H1 | Highest PDOP < 1.0 |
| | 1-2 | High |
| | 2-5 | Good |
| | 5-10 | Sufficient |
| | 10-20 | Low |
| | L0 | Very Low PDOP > 20 |

14.2. Factory Reset

Navigation

Menu:



Item:



Available values:

0, 1

Available Settings

| Value(s) | Description |
|-------------------|---|
| 0 (default value) | No function |
| 1 * | Invoke factory reset, proceeds to enter Submenu for Factory Reset |

14.2.1. Submenu for Factory Reset

| Value(s) | Description |
|--------------|---|
| <i>F A C</i> | <i>F A C</i> inscription flashes, confirming the PB2L push-button or the OK button on the remote control will restart the clock to factory settings |



The detailed procedure and other types of factory reset are described in the Factory Reset to Default Values chapter.

14.3. Firmware Update via USB Process Settings

✓ Added in version r7.07.



Available only for LGC or GPS variant.

Navigation

Menu:

Item:

Available values:

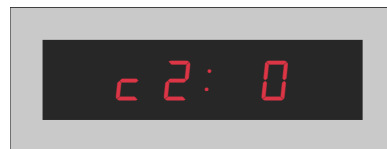

0, 1

Description

Firmware update is a process of upgrading software that is embedded in a hardware device. These updated can bring various benefits, such as bug fixes or new features. This settings allows to update the firmware of the clock via USB drive with update file on it.



Detailed firmware update via USB procedure can be found in chapter Firmware update via USB .

Available Settings

| Value(s) | Description |
|--------------------------|---|
| <i>0</i> (default value) | No function |
| <i>1</i> * | Invoke firmware update process Enter the submenu for firmware update |

Submenu

Submenu for Firmware Update

| Value(s) | Description |
|--------------------|--|
| <i>F U: xx</i> | <i>F U: xx</i> inscription flashes, where xx represents USB signalization state |
| <i>F U: 1 - 99</i> | the process of copying file |

| Value(s) | Description |
|----------------|--------------------------------|
| <i>F U: 0</i> | USB drive initialization is OK |
| <i>F U:- 1</i> | USB drive not loaded |
| <i>F U:- 2</i> | update file not found |
| <i>F U:- 3</i> | invalid file for the device |
| <i>F U:- 4</i> | unknown error |

For state *0* , confirming **OK** or **PB2L** starts the update process; if the file on the drive is OK, the copy process starts and its progress is displayed as a positive number in range *1 - 99* .

14.4. Clock Address for IR Remote Controller



If your firmware version is **r7.14** or lower, you may find this setting in the *d 1 5 P* menu item *d 8* .

Navigation

Menu:

Item:

Available values:

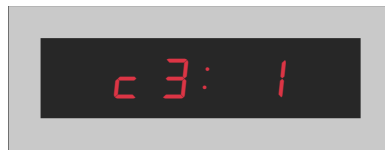

1 - 99

Description

The clock address for an IR remote controller is a specific identifier assigned to digital clock. This code serves as unique “address” that allows the remote controller to communicate and control particular clock. The clock control address is essential for ensuring that the remote controller signals and commands are received by the target device.

Available Settings

| Value(s) | Description |
|---------------|-------------------|
| <i>1 - 99</i> | Set clock address |



More information can be found in Clock Address Display chapter.

14.5. IR Remote Controller Auto-Lock



If your firmware version is **r7.14** or lower, you may find this setting in the **d 1 5 P** menu item **d 9**.

Navigation

Menu:

Item:

Available values:

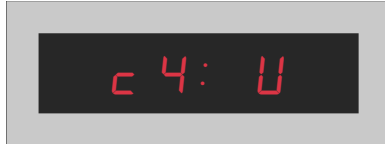
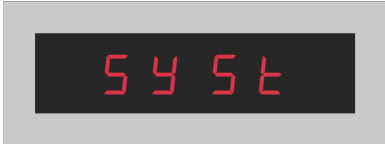

1 - 60, U

Description

This feature ensures the IR reception lock of digital clock after a specific period of inactivity (since the last press of any button on the IR remote controller), preventing unintentional button presses on the IR remote controller.

Available Settings

| Value(s) | Description |
|-------------------------|--|
| 1 - 60 (minutes) | Time in minutes for auto-lock since last press of a button on IR remote controller |
| U | Auto-Lock is OFF |



More information can be found in Automatic Lock.

14.6. Remote Control Lock



If your firmware version is **r7.14** or lower, you may find these setting in the **d 1 5 P** menu (see Remote Control Lock chapter).

The clock can be locked against unauthorized or unwanted operation using the remote controller.

14.6.1. Manual Lock

To lock all clock within the range of IR remote controller beam, long-press the **F2** button. Clock lock is indicated by displaying **L O C** on the clock display.



14.6.2. Automatic Lock



To set the IR remote controller auto-lock after time period, navigate to the **S Y S t** menu item **c 4** (see IR Remote Controller Auto-Lock chapter).

Automatic lock of the clock after **x** minutes is not indicated on the display.

14.6.3. Clock Address Display



To set clock address for IR remote controller, navigate to the **S Y S t** menu item **c 3** (see Clock Address for IR Remote Controller chapter).

The address display is enabled by press of the **F3** button and is indicated on the display as **A xx**.



The address is displayed only when the clock is locked.

xx represents the set address with initial zero.



A 0 1 → Clock Address 1

14.6.4. Unlocking the Clock

To unlock all clocks within the range of the IR remote controller beam, long-press the **F1** button. Clock unlock is indicated by displaying **U N L** on the clock display.



To unlock only specific clock with a specific address, press the **F1** button followed by the clock address in two-digit format with leading zero.



Thus, for a clock with address 5, the sequence will be as follows:

Press the **F1** button → Set the first digit number to **0** → Set the second digit number to **5**

Successful unlocking is indicated by displaying **U N L** on the clock display.

14.7. Display Brightness Derating

✔ Added in version r8.0.

Navigation

Menu:

Item:

Available values:



0, - 1, - 2, - 3, - 4, - 5

Description

Display brightness derating is a feature that adjusts the brightness of display based on specific conditions or user preferences.

Available Settings

| Value | Description |
|-------|----------------------------------|
| 0 | Display Brightness Derating 0% |
| - 1 | Display Brightness Derating -10% |
| - 2 | Display Brightness Derating -20% |
| - 3 | Display Brightness Derating -30% |
| - 4 | Display Brightness Derating -40% |
| - 5 | Display Brightness Derating -50% |

14.8. Light Sensor Correction

✔ Added in version r8.0.

Navigation

Menu:

Item:

Available values:

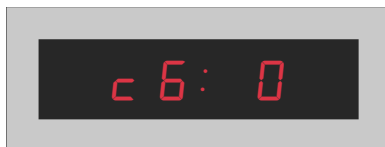
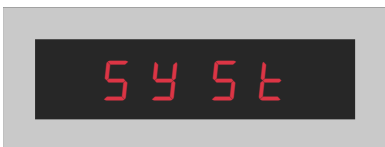

5, 4, 3, 2, 1, 0, - 1, - 2, - 3, - 4, - 5

Description

Light sensor correction setting is a feature designed to optimize the accuracy and performance of light sensor used to automatically adjust a display brightness.

Available Settings

| Value | Description |
|-------|------------------------------|
| 5 | Light Sensor Correction 50% |
| 4 | Light Sensor Correction 40% |
| 3 | Light Sensor Correction 30% |
| 2 | Light Sensor Correction 20% |
| 1 | Light Sensor Correction 10% |
| 0 | Light Sensor Correction 0% |
| - 1 | Light Sensor Correction -10% |
| - 2 | Light Sensor Correction -20% |
| - 3 | Light Sensor Correction -30% |
| - 4 | Light Sensor Correction -40% |
| - 5 | Light Sensor Correction -50% |

14.9. Individual Digit Brightness Setting

✔ Added in version r8.02.



This menu item may not be available to all users. Its availability can vary depending on device configuration.
 This menu item may be available for all users in future versions.

Navigation

Menu:



Item:



Available values:

d i (submenu)

Description

This setting allows you to adjust the brightness of individual digits. Each digit is adjusted separately, with values ranging from values 0 to E (values 0 - 9, then values A - E). This is useful in cases where certain digits are brighter than other, and you need to balance their brightness.

Proceed to enter the submenu d i by pressing **PB2L** or **OK** on IR remote controller.

Submenu

Submenu *d* ,

| Value | Description | Range |
|---|--|--------------|
| <i>00:00.</i> <i>00:00.00.</i> <i>00:00:00.</i> | Setting of display brightness of individual digits (set value is blinking) | <i>0 - E</i> |

14.9.1. Settings Procedure

1. Enter the submenu *d* , by pressing **PB2L** or **OK** on IR remote controller. The first digit is blinking.
2. Set your desired brightness ranging from *0* (no change to brightness) to *E* (maximal brightness reduction):
 - To increase the set value (increase brightness reduction), press the **PB2** button or **+** button on IR remote controller.
 - To decrease the set value, press the **PB1** button or **-** button on IR remote controller.
3. If you are satisfied with the set brightness, press the **PB2L** or **OK** on IR remote controller to move to next digit. The next digit is blinking. Repeat the procedure.
4. If you are satisfied with the brightness of all digits, press the the **PB2L** or **OK** on IR remote controller until the end. It will automaticaly save the set values and return to SYSt menu item *c 7:d* , .

14.10. Individual Dot Brightness Setting

✔ Added in version r8.02.



This menu item may not be available to all users. Its availability can vary depending on device configuration.
This menu item may be available for all users in future versions.

Navigation

Menu:

Item:

Available values:

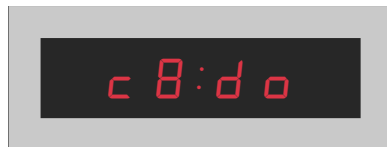

d 0 (submenu)



Description

This setting allows you to adjust the brightness of individual dots. Each dot is adjusted separately, with values ranging from values *0* to *E* (values *0 - 9* , then values *A - E*). This is useful in cases where certain dots are brighter than other, and you need to balance their brightness.

Proceed to enter the submenu *d 0* by pressing **PB2L** or **OK** on IR remote controller.

Submenu

Submenu $d \square$

| Value | Description | Range |
|---|--|---------|
|    | Setting of display brightness of individual dots (digit is blinking – see table below for more info) | $0 - E$ |

14.10.1. Settings Procedure

1. Enter the submenu $d \square$ by pressing **PB2L** or **OK** on IR remote controller. The first digit is blinking (this indicated setting of brightness of the first dot).
For more information of what digits represents what dot, please see the figure or table below.
2. Set your desired brightness of dot ranging from 0 (no change to brightness) to E (maximal brightness reduction):
 - To increase the set value (increase brightness reduction), press the **PB2** button or **+** button on IR remote controller.
 - To decrease the set value, press the **PB1** button or **-** button on IR remote controller.
3. If you are satisfied with the set brightness, press the **PB2L** or **OK** on IR remote controller to move to next dot setting. The next digit representing next dot is blinking. Repeat the procedure.
4. If you are satisfied with the brightness of all dots, press the **PB2L** or **OK** on IR remote controller until the end. It will automatically save the set values and return to SYSt menu item $c B:d \square$.

Digits > Dots

| Flashing Digit | Set Dot |
|--------------------------|--|
| First digit | Dot on top left corner (AM / PM indication) |
| Second digit | Dot on bottom right corner next to second digit |
| Third digit | First colon |
| Fourth digit | Dot on bottom right corner next to fourth digit |
| Fifth digit ¹ | Second colon (for display configuration 4 + 2 digits no colon is displayed) |
| Sixth digit | Dot on bottom right corner next to sixth digit |

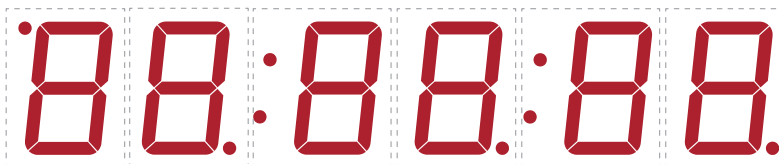

¹ Only for display configuration of 4 + 2 or 6 digits.

15 Local time calculation

15.1. According to Synchronization Source

This setting is suitable for digital clock synchronized by a DCF receiver or controlled by a master clock as SLAVE clock in a time distribution system. The internal timezone table is not used.

| Item | Set Value(s) | Description |
|------|-----------------|---|
| o 1 | A | Timezone is takes over according to the source of synchronization |
| o 2 | 2 - 9 , 1 1 , A | Synchronization signal type |
| o 4 | 0 | MOBALine timezone is not used |
| o 5 | 0 | Timezone server is not used |
| d 2 | A | Display time and date according to source of synchronization including daylight saving time |

15.2. According to MOBALine Timezones

This setting is suitable for digital clock controlled by a MASTER clock as a MOBALine SLAVE clock in a time distribution system with possibility to display different MOBALine timezones.

| Item | Set Value(s) | Description |
|------|--------------|--|
| o 1 | A | Timezone is taken over according to the source of synchronization, the UTC time calculation is based on the MOBALine information |
| o 2 | 4 | MOBALine |
| o 4 | 1 - 2 0 | Selection of MOBALine timezone |
| d 2 | A | Display time and date according to chosen MOBALine timezone including daylight saving time |

15.3. According to MOBA-NMS Preconfigured Timezones

This setting is suitable for NTP, PoE, WiFi and WiFi5 digital clock where several user defined timezones entries should be used. The timezone entries are preconfigured by means of the MOBA-NMS software.

| Item | Set Value(s) | Description |
|------|--------------|--------------------------------|
| o 1 | A | NTP protocol uses UTC timezone |
| o 2 | A | Automatic |

| Item | Set Value(s) | Description |
|------|--------------|---|
| o 5 | 0 | No timezone server is used |
| d 2 | U 1 - U 7 | Display time and date according to chosen preconfigured timezone entry including daylight saving time |

15.4. According to Server MOBATIME

This setting is suitable for NTP, PoE, WiFi and WiFi5 digital clock controlled by MOBATIME NTP servers which supports the timezone server functionality.

| Item | Set Value(s) | Description |
|------|--------------|---|
| o 1 | A | NTP protocol uses UTC time |
| o 2 | A | Automatic |
| o 5 | 1 - 15 | Selection of the time zone server time zone |
| d 2 | A | Display time and date according to chosen time zone server time zone including daylight saving time |

15.5. According to Internal Timezone Table

This setting is suitable for autonomous digital clocks or in cases where the displayed time is needed in another timezone than provided by the synchronization source. Displayed time and date calculation is based on the internal timezone table or on the user-specific timezone parameters – see Timezones Table chapter.

| Item | Set Value(s) | Description |
|------|--------------|--|
| o 1 | 0 - 64, A | According to the timezone in which the source of synchronization works (e.g. value 2 for DCF in west Europe, value A for NTP synchronization) Value A only for synchronization source working with UTC time |
| o 2 | 1 - 11, A | Autonomous operation or any type of the synchronization signal |
| o 4 | 0 | MOBALine timezone is not used |
| o 5 | 0 | Timezone server is not used |
| d 2 | 0 - 64, U | Display time and date by calculation from the UTC time according to chosen timezone including daylight saving time |

16 Timezones Table

Time zones are a system of dividing the Earth's surface into regions, each with its own unique time offset from UTC (Coordinated Universal Time) or GMT (Greenwich Mean Time) and which may have different rules for change seasonal time. This division allows for consistent and synchronized timekeeping across the globe.

| No. | City / State | UTC Offset | DST | Standard → DST | DST → Standard |
|-----|--|------------|-----|---------------------------------|--------------------------------|
| 00 | UTC GMT, Monrovia, Casablanca | 0 | No | | |
| 01 | London, Dublin, Edinburgh, Lisbon | 0 | Yes | last Sunday March (01:00) | last Sunday October (02:00) |
| 02 | Brussels, Amsterdam, Berlin, Bern, Copenhagen, Madrid, Oslo, Paris, Rome, Stockholm, Vienna, Belgrade, Bratislava, Prague, Budapest, Ljubljana, Sarajevo, Sofia, Vilnius, Warsaw, Zagreb | +1 | Yes | last Sunday March (02:00) | last Sunday October (03:00) |
| 03 | Athens, Helsinki, Riga, Tallinn | +2 | Yes | last Sunday March (03:00) | last Sunday October (04:00) |
| 04 | Bucharest | +2 | Yes | last Sunday March (03:00) | last Sunday October (04:00) |
| 05 | Pretoria, Harare, Kaliningrad | +2 | No | | |
| 06 | Amman | +2 | Yes | last Thursdays March (23:59) | last Friday October (01:00) |
| 07 | UTC (GMT) | 0 | No | | |
| 08 | Istanbul, Kuwait City, Minsk, Moscow, Saint Petersburg, Volgograd | +3 | No | | |
| 09 | Praia, Cape Verde | -1 | No | | |
| 10 | UTC (GMT) | 0 | No | | |
| 11 | Abu Dhabi, Muscat, Tbilisi, Samara | +4 | No | | |
| 12 | Kabul | +4.5 | No | | |
| 13 | Adamstown (Pitcairn Is.) | -8 | No | | |
| 14 | Tashkent, Islamabad, Karachi, Yekaterinburg | +5 | No | | |
| 15 | Mumbai, Kolkata, Chennai, New Delhi, Colombo | +5.5 | No | | |
| 16 | Astana, Thimphu, Dhaka, Novosibirsk | +6 | No | | |
| 17 | Bangkok, Hanoi, Jakarta, Krasnoyarsk | +7 | No | | |
| 18 | Beijing, Hong Kong, Singapore, Taipei, Irkutsk | +8 | No | | |
| 19 | Tokyo, Seoul, Yakutsk | +9 | No | | |
| 20 | Gambier Island | -9 | No | | |

| No. | City / State | UTC Offset | DST | Standard → DST | DST → Standard |
|-----|--|------------|-----|--|---|
| 21 | South Australia: Adelaide | +9.5 | No | | |
| 22 | Northern Territory: Darwin | +9.5 | No | | |
| 23 | Brisbane, Guam, Port Moresby, Vladivostok | +10 | No | | |
| 24 | Sydney, Canberra, Melbourne, Tasmania: Hobart | +10 | Yes | 1 st Sunday October (02:00) | 1 st Sunday April (03:00) |
| 25 | UTC (GMT) | 0 | No | | |
| 26 | UTC (GMT) | 0 | No | | |
| 27 | Honiara (Solomon Is.), Magadan, Noumea (New Caledonia) | +11 | No | | |
| 28 | Auckland, Wellington | +12 | Yes | last Sunday September (02:00) | 1 st Sunday April (03:00) |
| 29 | Majuro (Marshall Is.), Anadyr | +12 | No | | |
| 30 | Azores | -1 | Yes | last Sunday March (00:00) | last Sunday October (01:00) |
| 31 | Middle Atlantic | -2 | No | | |
| 32 | Brasilia | -3 | Yes | 3 rd Sunday October (00:00) | 3 rd Sunday February (00:00) |
| 33 | Buenos Aires | -3 | No | | |
| 34 | Newfoundland | -3.5 | Yes | 2 nd Sunday March (02:00) | 1 st Sunday November (02:00) |
| 35 | Atlantic Time (Canada) | -4 | Yes | 2 nd Sunday March (02:00) | 1 st Sunday November (02:00) |
| 36 | La Paz | -4 | No | | |
| 37 | Bogota, Lima, Quito | -5 | No | | |
| 38 | New York, Eastern Time (US & Canada) | -5 | Yes | 2 nd Sunday March (02:00) | 1 st Sunday November (02:00) |
| 39 | Chicago, Central Time (US & Canada) | -6 | Yes | 2 nd Sunday March (02:00) | 1 st Sunday November (02:00) |
| 40 | Tegucigalpa, Honduras | -6 | No | | |
| 41 | Phoenix, Arizona | -7 | No | | |
| 42 | Denver, Mountain Time | -7 | Yes | 2 nd Sunday March (02:00) | 1 st Sunday November (02:00) |
| 43 | Los Angeles, Pacific Time | -8 | Yes | 2 nd Sunday March (02:00) | 1 st Sunday November (02:00) |
| 44 | Anchorage, Alaska (US) | -9 | Yes | 2 nd Sunday March (02:00) | 1 st Sunday November (02:00) |

| No. | City / State | UTC Offset | DST | Standard → DST | DST → Standard |
|-----|-----------------------------|------------|-----|--------------------------------------|---|
| 45 | Honolulu, Hawaii (US) | -10 | No | | |
| 46 | Midway Is. (US) | -11 | No | | |
| 47 | Mexico City, Mexico | -6 | Yes | 1 st Sunday April (02:00) | last Sunday October (02:00) |
| 48 | Adak (Aleutian Is.) | -10 | Yes | 2 nd Sunday March (02:00) | 1 st Sunday November (02:00) |
| 49 | UTC (GMT) | 0 | No | | |
| 50 | UTC (GMT) | 0 | No | | |
| 51 | UTC (GMT) | 0 | No | | |
| 52 | UTC (GMT) | 0 | No | | |
| 53 | UTC (GMT) | 0 | No | | |
| 54 | Ittoqqortoormiit, Greenland | -1 | Yes | last Sunday March (00:00) | last Sunday October (01:00) |
| 55 | Nuuk, Qaanaaq, Greenland | -3 | Yes | last Saturday March (22:00) | last Saturday October (23:00) |
| 56 | Myanmar | +6.5 | No | | |
| 57 | Western Australia: Perth | +8 | No | | |
| 58 | Caracas | -4.5 | No | | |
| 59 | CET standard time | +1 | No | | |
| 60 | not used | | | | |
| 61 | not used | | | | |
| 62 | Baku | +4 | Yes | last Sunday March (04:00) | last Sunday October (05:00) |
| 63 | UTC (GMT) | 0 | No | | |
| 64 | UTC (GMT) | 0 | No | | |

Legend

| | |
|-------------------------|--|
| UTC : | Coordinated Universal Time |
| UTC Offset : | Time difference from UTC time |
| DST : | Daylight Saving Time |
| Standard → DST : | Time change from Standard (Winter) Time to Summer Time |
| DST → Standard : | Time change from Summer Time to Standard (Winter Time) |



2nd last Sunday March (02:00)



switch over on the penultimate Sunday in March at 02:00 hours local time

17 Factory Reset to Default Values

17.1. Factory Reset Using Menu

In an event that the clock gets to state that it does not work properly due to incorrect configuration or it is not possible to connect to the clock via Ethernet, the situation can be solved by invoking the factory settings from the clock menu Factory Reset (the **5 4 5 6** menu item **c !**).

17.1.1. Procedure

1. Enter the digital clock menu using the **PB2L** push-button or the **MENU** button on the remote control.
2. Use **PB2** push-button or **>>** button on the remote control to navigate to the **5 4 5 6** menu.
To enter, press the **PB2L** push-button or the **OK** button on the remote control.
3. Use **PB2** push-button or **>>** button on the remote control to navigate to the menu item **c !**.
To enter, press the **PB2L** push-button or the **OK** button on the remote control. Set value is flashing.
4. Use the **PB2** push-button or the **+** button on the remote control increase the value to **!**.
F A C inscription flashes.
5. Confirming the **PB2L** push-button or the **OK** button on the remote control will restart the clock to factory settings.

17.2. Factory Reset via Web Interface

If your clock is synchronized using the NTP protocol and has access to the web interface, it is possible to invoke the default values through the web interface (Command Tab).

17.2.1. Procedure

1. Access the web interface.



For instruction on accessing the web interface, please refer to the How to Access the Web Interface? chapter.

2. Navigate to Command tab .
3. Set the field **Factory reset** to **Perform reset** and click on **Apply** .
4. The clock restarts to factory settings.

17.3. Factory Reset Using Push-Buttons

✔ **Added in version r7.16.**

In extreme cases where a misconfiguration causes the clock to enter a reset loop, the clock menu becomes inaccessible, and it is impossible to invoke the default values through the menu.

The issue can be resolved by using a specific combination of push-button presses to perform a factory reset.

17.3.1. Procedure

1. Connect the clock to power supply.
2. Press and hold **PB1** and **PB2** push-buttons at the same time.
3. Restart the clock by briefly pressing the reset button while holding **PB1** and **PB2** push-buttons at the same time.



The reset button is located inside of the clock on clock's control module located on PCB.

Remove the front panel from the clock body. The panel is held by magnets, relatively high force required to remove it.

The button is small yellow button labeled **RESET**.

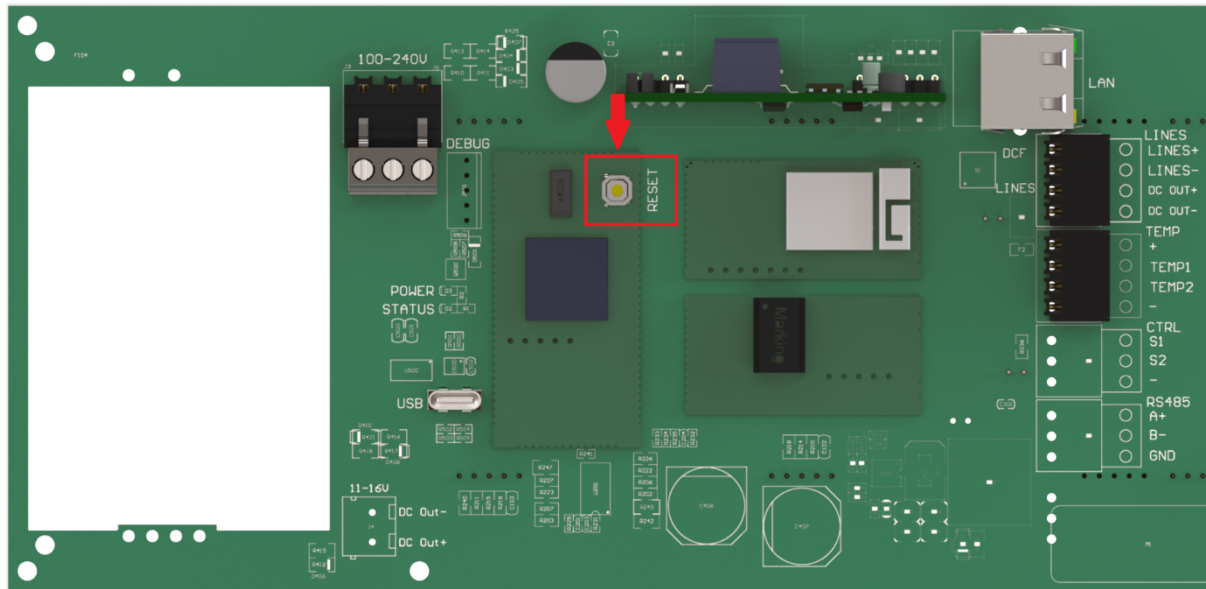

4. Hold both **PB1** and **PB2** push-buttons until **FAC** appears on the clock display (in approx. 5 seconds).
5. Release **PB1** and **PB2** push-buttons. The clock restarts to factory settings.

18 Firmware update

This section provides instruction and information on how to update the clock's firmware, which is the software that runs on the clock's internal processor. Firmware updates can bring new features, improvements and bug fixes.



The current firmware version as of 13.05.26: `r8.22`



When updating from version `r7.x` (version lower than `r8.0`) to version e.g. `r8.2`, you **must** first update to version `r8.0` (to download, go to the URL <<https://docs.mobatime.cloud/ECO-SLH-DC/firmware/bin/dc4-8.00.zip>>). Only then can you update freely to any version. **This intermediate step is crucial!**

18.1. Firmware update via MOBA-NMS

For instruction about firmware update via MOBA-NMS, please visit www.mobatime.com/product/moba-nms/.

18.2. Firmware update via SNMP

1. Install TFTP server (e.g. `tftpd32`).
2. Allow access in Windows security window after opening TFTP server file.

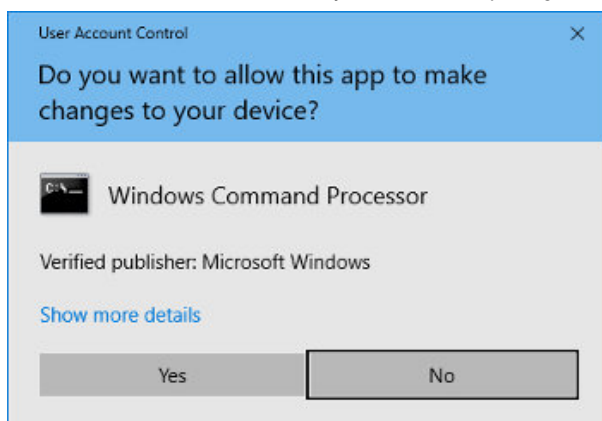

3. Place the firmware file named `device.upd` to folder from which your TFTP server serve files.
4. Open your SNMP manager software and load MIB file.



To download the MIB file, visit the following URL: <https://docs.mobatime.cloud/ECO-SLH-DC/snmp>

5. Find variable `mbnscCommandFirmwUpd` (OID = `.1.3.6.1.4.1.13842.6.2.7.4`) and set it to `device.upd`.
6. In dependence of your TFTP server, information about update progress is displayed.
7. Wait about 1 minute after firmware download.
8. Check whether the firmware version is correct.



If the firmware version is not correct, it is necessary to repeat the procedure.

18.3. Firmware update via web server

1. Install TFTP server (e.g. `tftpd32`).
-

2. Allow access in Windows security window after opening TFTP server file.

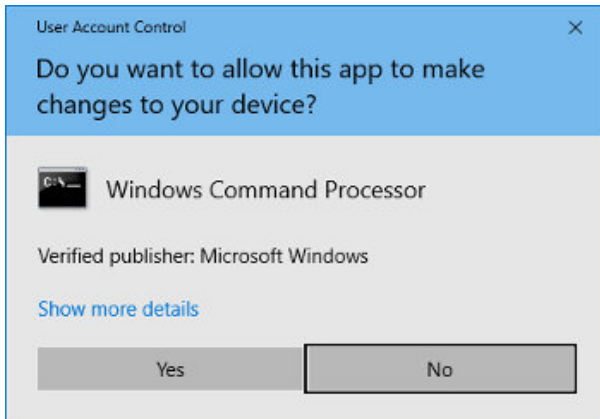

3. Place the firmware file named `device.upd` to folder from which your TFTP server serve files.
4. Open the web interface of the digital clock you want to update.



For instruction on accessing the web interface, please refer to the How to Access the Web Interface? chapter.

5. In web interface, Navigate to Command tab.
6. Set the field "Firmware update" to "Perform update over TFTP" and click on "Apply" . Update will be invoked.
7. In dependence of your TFTP server, information about update progress is displayed.
8. Wait about 1 minute after firmware download.
9. Check whether the firmware version is correct.



If the firmware version is not correct, it is necessary to repeat the procedure.

18.4. Firmware update via USB

✓ Added in version r7.07.



Firmware update via USB is available only for LGC or GPS variant of digital clock.

1. Upload the firmware file named `device.upd` to the USB drive.
2. Connect the USB drive to the clock using the USB-C connector on the clock PCB.
3. Open the clock menu, go to the `5 4 5 1` submenu and proceed to enter.
4. Navigate to menu item `c 2` (see Firmware Update via USB Process Settings chapter).
5. Setting the item `c 2` to value `1` will activate the firmware update process.

First step of the Firmware update process is to load the USB device.

The display will show a flashing `F U: xx` , where `xx` represents the result of the process:



- `0` : USB drive connected
- `- 1` : USB drive not found

If the USB drive is not found, format the USB drive to NTFS format.

6. If `F U: 0` is displayed, the file transfer can be started by pressing `OK` button on IR remote controller or by pressing `PB2L` .
7. If the file on the USB drive is OK, the message stops flashing and `F U: xx` is displayed with only flashing colons, where `xx` already represents the percentage progress of the file transfer.
 - If the file is invalid for the device, `F U: - 3` will flash or if the file is not found, `F U: - 2` will flash.
8. When the file transfer is complete, the `d o n e` message is displayed and the clock resets after 2 seconds to complete the update process.



Until the file transfer starts, the menu can be exited by pressing the **PB1L** push-button or the **ESC** button on the IR remote control.

If the file transfer process fails and the copy process does not complete, the clock must be manually reset, **as the clock control by the buttons or IR remote controller is ignored during the file transfer** – see Factory Reset Using Push-Buttons chapter.

19 Clock specifications

These chapters provide detailed technical data about the clock's specifications and capabilities. These sections help users understand the clock's features, dimensions, power requirements and other important details.

19.1. Basic Data

| Display | 57.4 | 57.6 | 57x.6 | 100.4 | 100.6 | 100x.6 |
|----------------------|------|---------|-------|-------|----------|--------|
| Digit Height [mm] | 57 | 57 / 38 | 57 | 100 | 100 / 57 | 100 |
| Number of Digits | 4 | 4 + 2 | 6 | 4 | 4 + 2 | 6 |
| Viewing Distance [m] | 25 | | | 40 | | |

| Display Format | 57.4 | 57.6 | 57x.6 | 100.4 | 100.6 | 100x.6 |
|--|------|------|-------|-------|-------|--------|
| HH : MM DD. MM. | ✓ | × | × | ✓ | × | × |
| HH : MM ^{SS} DD. MM. ^{YY} | × | ✓ | × | × | ✓ | × |
| HH : MM : SS DD. MM. YY | × | × | ✓ | × | × | ✓ |

| Display Format | |
|----------------|--|
| Mains Powered | 100-240 VAC / 50-60 Hz |
| PoE | IEEE 802.3af-Class 3 |
| VDC Option | 18-55 V (see VDC Option Voltage Table chapter) |
| VDISP Option | Supply voltage depends on display color (see VDISP Option Voltage Table chapter) |

| Power Consumption | 57.4 | 57.6 | 57x.6 | 100.4 | 100.6 | 100x.6 |
|-------------------|------|------|-------|-------|-------|--------|
| Mains Powered | 7 | 8 | 8 | 7 | 8 | 10 |
| PoE | 7 | 8 | 8 | 7 | 8 | 10 |

Power consumption is in VA.

| Quartz Base and Running Reserve | |
|---------------------------------|--|
| Running Reserve | 96 hours by means of supercapacitor or 2 years with lithium battery |
| Accuracy | ±0.1 s/day without synchronization (after 24 hours of synchronization at constant temperature) |

| Accuracy of Temperature Management (for TP3/30m Sensors) | |
|--|---------|
| Range -25 to +85 °C | ±0.5 °C |
| Range -50 to +125 °C | ±2.0 °C |

| Operating Environment | |
|-----------------------|----------------------------------|
| Temperature | -5 to +55 °C |
| Humidity | 0 to 95 % (without condensation) |
| Protection Degree | IP 54 |

| Weight [kg] | 57.4 | 57.6 | 57x.6 | 100.4 | 100.6 | 100x.6 |
|--------------|------|------|-------|-------|-------|--------|
| Single Sided | 2.6 | 3.3 | 3.5 | 4.7 | 5.8 | 6.5 |

| Dimensions [mm] | 57.4 | 57.6 | 57x.6 | 100.4 | 100.6 | 100x.6 |
|-----------------|------|------|-------|-------|-------|--------|
| W × H × D | 57.4 | 57.6 | 57x.6 | 100.4 | 100.6 | 100x.6 |
| Single Sided | 380 | 470 | 500 | 570 | 710 | 785 |
| | 150 | 150 | 150 | 220 | 220 | 220 |
| | 39 | 39 | 39 | 39 | 39 | 39 |

19.2. Diagram & Dimensions

19.2.1. Without Back Cover Dimensions

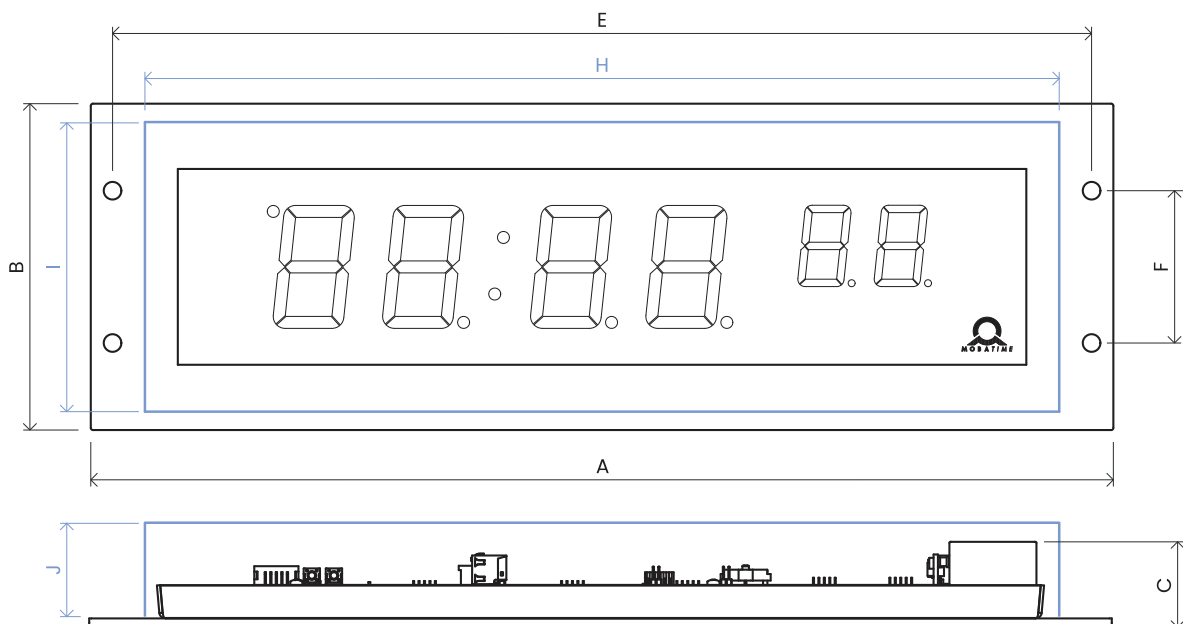

19.2.2. With Back Cover Dimensions

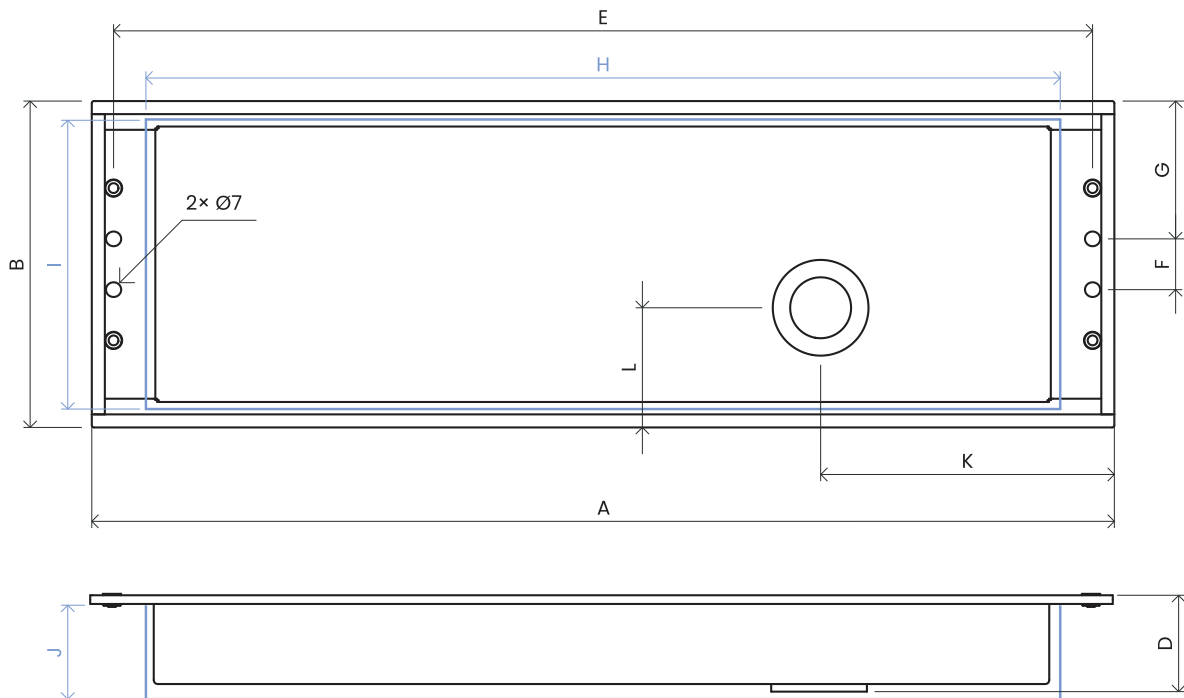

The Mounting Hole dimensions are indicated with Blue color.

19.2.3. Dimensions Table

Dimensions are in mm.

WO/ BC : Without Back Cover

W/ BC : With Back Cover

| Index | 57.4 | 57.6 | 57x.6 | 100.4 | 100.6 | 100x.6 |
|-------|----------------------------|----------------------------|----------------------------|-----------------------------|-----------------------------|-----------------------------|
| A | 380 | 470 | 500 | 570 | 710 | 785 |
| B | 150 | 150 | 150 | 220 | 220 | 220 |
| C | 39 (WO/ BC) 44 (W/ BC) | 39 (WO/ BC) 44 (W/ BC) | 39 (WO/ BC) 44 (W/ BC) | 39 (WO/ BC) 44 (W/ BC) | 39 (WO/ BC) 44 (W/ BC) | 39 (WO/ BC) 44 (W/ BC) |
| E | 360 | 450 | 480 | 550 | 690 | 765 |
| F | 70 (WO/ BC) 0 (W/ BC) | 70 (WO/ BC) 0 (W/ BC) | 70 (WO/ BC) 0 (W/ BC) | 120 (WO/ BC) 0 (W/ BC) | 120 (WO/ BC) 0 (W/ BC) | 120 (WO/ BC) 0 (W/ BC) |
| G | N/A (WO/ BC) 75 (W/ BC) | N/A (WO/ BC) 75 (W/ BC) | N/A (WO/ BC) 75 (W/ BC) | N/A (WO/ BC) 110 (W/ BC) | N/A (WO/ BC) 110 (W/ BC) | N/A (WO/ BC) 110 (W/ BC) |
| H | 325 | 415 | 445 | 520 (WO/ BC) 525 (W/ BC) | 660 | 735 (WO/ BC) 740 (W/ BC) |

| Index | 57.4 | 57.6 | 57x.6 | 100.4 | 100.6 | 100x.6 |
|-------|----------------------------|-----------------------------|----------------------------|-----------------------------|-----------------------------|-----------------------------|
| I | 130 | 130 | 130 | 185 (WO/ BC) 190 (W/ BC) | 185 | 185 (WO/ BC) 188 (W/ BC) |
| J | 50 | 50 | 50 | 50 | 50 | 50 |
| K | N/A (WO/ BC) 55 (W/ BC) | N/A (WO/ BC) 55 (W/ BC) | N/A (WO/ BC) 55 (W/ BC) | N/A (WO/ BC) 90 (W/ BC) | N/A (WO/ BC) 90 (W/ BC) | N/A (WO/ BC) 90 (W/ BC) |
| L | N/A (WO/ BC) 90 (W/ BC) | N/A (WO/ BC) 135 (W/ BC) | N/A (WO/ BC) 90 (W/ BC) | N/A (WO/ BC) 150 (W/ BC) | N/A (WO/ BC) 255 (W/ BC) | N/A (WO/ BC) 290 (W/ BC) |

19.3. VDC Option Voltage Table



Abbreviations used:

R – Red; **PG** – Pure green; **B** – Blue; **W** – White; **A** – Yellow; **G** – Green

19.3.1. 7-Segment Display

| Size | R | PG | B | W | A | G |
|--------|---|----|-------|---|---|---|
| 57.4 | | | 18–55 | | | |
| 57.6 | | | 18–55 | | | |
| 57x.6 | | | 18–55 | | | |
| 100.4 | | | 18–55 | | | |
| 100.6 | | | 18–55 | | | |
| 100x.6 | | | 18–55 | | | |

Voltage is in V.

19.3.2. SMD LED Display



Available only for digital clock with option **SL**.

| Size | R | PG | B | W | A | G |
|--------|---|----|-------|---|---|---|
| 57.4 | | | 18–55 | | | – |
| 57.6 | | | 18–55 | | | – |
| 57x.6 | | | 18–55 | | | – |
| 100.4 | | | 18–55 | | | – |
| 100.6 | | | 18–55 | | | – |
| 100x.6 | | | 18–55 | | | – |

Voltage is in V.

19.4. VDISP Option Voltage Table



Abbreviations used:

R – Red; **PG** – Pure green; **B** – Blue; **W** – White; **A** – Yellow; **G** – Green

19.4.1. 7-Segment Display

| Size | R | PG | B | W | A | G |
|--------|----|----|----|---|---|----|
| 57.4 | 12 | | 14 | | | 12 |
| 57.6 | 12 | | 14 | | | 12 |
| 57x.6 | 12 | | 14 | | | 12 |
| 100.4 | 12 | | 14 | | | 12 |
| 100.6 | 12 | | 14 | | | 12 |
| 100x.6 | 12 | | 14 | | | 12 |

Voltage is in V.

19.4.2. SMD LED Display



Available only for digital clock with option **SL**.

| Size | R | PG | B | W | A | G |
|--------|----|----|----|---|----|---|
| 57.4 | 15 | | 18 | | 15 | - |
| 57.6 | 15 | | 18 | | 15 | - |
| 57x.6 | 15 | | 18 | | 15 | - |
| 100.4 | 15 | | 18 | | 15 | - |
| 100.6 | 15 | | 18 | | 15 | - |
| 100x.6 | 15 | | 18 | | 15 | - |

Voltage is in V.

19.5. LINES Input Voltage Range for Control Signals



For LGC variant.

| Type of Slave Line | Voltage Range | Input Current Range |
|--------------------|---------------|---------------------|
| MOBALine | 5–30 VAC | 0.1–0.65 mA |
| Impulse, CODE | ±12–30 V | 0.25–0.51 mA |
| IRIG-B | 0.2–2 Vpp | 5–45 µA |

20 Frequently asked questions

Here you will find answers to frequently asked questions.

20.1. General Questions

How can I tell if the clock is not synchronized? >

The colon(s) will start blinking. The default timeout for indication of state without synchronization is **24 hours**.

You can set your own timeout in hours, see chapter **Synchronization Settings > Timeout for Indication of State without Synchronization**.

How to exit "Power OFF" mode? >

To exit "Power OFF" mode, either press push-button **PB1L** or **PB2L**, or **DISP** button on IR remote controller.

How to reset the digital clock to factory settings? >

If the clock is fully operational :

Enter the **S Y S E** menu item **e 1** (see chapter **Factory Reset to Default Values > Factory Reset Using Menu**). Set the value to **1** and confirm entered value. The **F A C** inscription will flash on display, and by confirming the clock will reset to default values.

If the clock is not responding or has entered a reset loop :

You need to do the factory reset using push-buttons (see chapter **Factory Reset to Default Values > Factory Reset Using Push-Buttons**).

20.2. Local Time Calculation Questions

I have digital clock synchronized by a DCF receiver or controlled by a MASTER clock. How to configure the calculation of local time? >

Internal timezone table is not used. To show correct local time, set following items to values:

1. Navigate to **S Y N C** menu item **o 1** and set it to value **A**. That ensures the timezone is taken over according to the source of synchronization.
2. Navigate to **S Y N C** menu item **o 2** and set it to value **2 - 9**, **1 1** or **A** (autodetection). Select your synchronization type.
3. Navigate to **S Y N C** menu item **o 4** and disable the MOBALine timezone (set value **0**).
4. Navigate to **S Y N C** menu item **o 5** and disable the MOBATIME server timezone (set value **0**).
5. Navigate to **d I S P** menu item **d 2** and set it to value **A** (automatically set timezone). Time and date is displayed according to source of synchronization including daylight saving time.

I have digital clock controlled by a MASTER clock as MOBALine SLAVE clock and I want to use MOBALine timezones. How to configure the calculation of local time? >

To show correct local time, set following items to values:

1. Navigate to **S Y N C** menu item **0 1** and set it to value **A**. That ensures the timezone is taken over according to the source of synchronization and the UTC time calculation is based on the MOBALine information.
2. Navigate to **S Y N C** menu item **0 2** and set it to value **4** (MOBALine synchronization type).
3. Navigate to **S Y N C** menu item **0 4** and set your **desired MOBALine timezone** (values **1 - 2 0**).
4. Navigate to **d I S P** menu item **d 2** and set it to value **A** (automatically set timezone). Time and date is displayed according to chosen MOBALine timezone including daylight saving time.

I have NTP, PoE, WiFi or WiFi5 variant of digital clock controlled by MOBATIME NTP servers. How to configure the calculation of local time? >

To show correct local time, set following items to values:

1. Navigate to **S Y N C** menu item **0 1** and set it to value **A** (automatically set timezone). NTP protocol then uses UTC time.
2. Navigate to **S Y N C** menu item **0 2** and set it to value **A** (autodetection).
3. Navigate to **S Y N C** menu item **0 5** and set your **desired MOBATIME server timezone** (values **1 - 1 5**).
4. Navigate to **d I S P** menu item **d 2** and set it to value **A** (automatically set timezone). Time and date is displayed according to chosen MOBATIME server timezone including daylight saving time.

I need to display another timezone than timezone provided by the synchronization source. How to set the desired timezone? >

To set desired timezone, set following items to values:

1. Navigate to **S Y N C** menu item **0 1** and set it to value **0 - 6 4** or **A** (automatically set timezone). Set the value according to the timezone in which the source of synchronization works.



See chapter **Timezones Table**.



Value **2** for DCF in west Europe or value **A** for NTP synchronization



Value **A** only for synchronization working with UTC time.

2. Navigate to **S Y N C** menu item **0 2** and set it to value **1 - 1 1** or **A** (autodetection). Select your synchronization type.
3. Navigate to **S Y N C** menu item **0 4** and disable the MOBALine timezone (set value **0**).
4. Navigate to **S Y N C** menu item **0 5** and disable the MOBATIME server timezone (set value **0**).
5. Navigate to **d I S P** menu item **d 2** and set it to value **0 - 6 4** or **A** (automatically set timezone). Time and date is displayed according to calculation from the UTC time according to desired timezone including daylight saving time.



*Headquarters/Production
Sales Worldwide*

Tel. +41 34 432 46 46 | Fax +41 34 432 46 99
moserbaer@mobatime.com | www.mobatime.com

Sales Switzerland

MOBATIME AG | Stettbachstrasse 5 | CH-8600 Dübendorf
Tel. +41 44 802 75 75 | Fax +41 44 802 75 65
info-d@mobatime.ch | www.mobatime.ch

MOBATIME SA | En Budron H 20 | CH-1052 Le Mont-sur-Lausanne
Tél. +41 21 654 33 50 | Fax +41 21 654 33 69
info-f@mobatime.ch | www.mobatime.ch

Sales Germany/Austria

BÜRK MOBATIME GmbH
Postfach 3760 | D-78026 VS-Schwenningen
Steinkirchring 46 | D-78056 VS-Schwenningen
Tel. +49 7720 / 85 35 - 0 | Fax +49 7720 / 85 35 - 11
buerk@buerk-mobatime.de | www.buerk-mobatime.de