

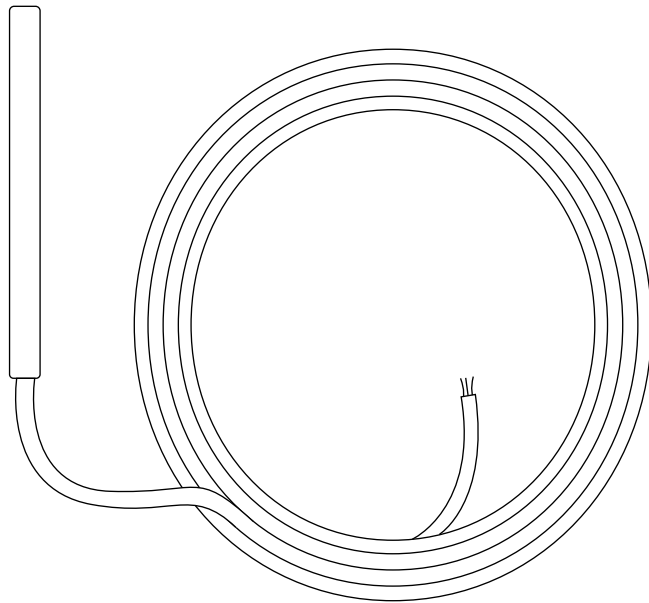

# User Manual

# TP 3m

# Temperature Sensor



Scan the QR code or enter following URL to get the latest version:  
<https://docs.mobatime.cloud/TP-3m>



# Regulations and Certification

---

The device fulfils the requirements of the following standards:

<b>Electrical safety :</b>	EN 62368-1 ED.2
<b>EMC :</b>	EN 55032 ED.2; EN 55035; EN 50121-4 ED.4

This product was developed and produced with the following EU directives:

<b>EMC :</b>	Electromagnetic compatibility directive <b>2014/30/EU</b>
<b>LVD :</b>	Low voltage directive <b>2014/35/EU</b>
<b>RED :</b>	Radio equipment directive <b>2014/53/EU</b>
<b>RoHS II :</b>	Restriction of the use of certain hazardous substances directive <b>2011/65/EU</b>
<b>WEEE :</b>	Waste electrical and electronic equipment directive <b>2012/19/EU</b>
<b>REACH :</b>	Chemical substance directive <b>ES 1907/2006</b>

See Conformity for the declaration of conformity of this specific product. This product may offer a CB test certificate on request.



## Important Notes

1. Please read and follow the safety information in this document before operating the product. We cannot guarantee that no accidents or damage will occur to improper use of this product. Please use this product with care and operate at your own risk.
2. We are not liable for any direct or indirect damage caused by the use of this document or the said product.
3. This product must be connected and installed by qualified electrician who is familiar with the relevant regulations (e.g. VDE).
4. The information in this document is subject to change without notice. The latest version of this document is available for download at <https://docs.mobatime.cloud/TP-3m/user-manual/pdf>.
5. This User Manual has been composed with the utmost care to explain all the details to ensure a safe and stable operation of this product. Nevertheless, if question arise or error appear, feel free to contact support.
6. Images shown are for illustrative purposes and may differ from the final product.
7. No part of this document or the said product may be reproduced in any form or by any means or used to make any derivative such as translation, transformation, or adaption without permission from ELEKON, s.r.o., Brněnská 364/17, Vyškov 682 01 / CZECH REPUBLIC.
8. Copyright © 2026 ELEKON, s.r.o., Brněnská 364/17, Vyškov 682 01 / CZECH REPUBLIC. All rights reserved.

# Table of Contents

---

- 1. **Safety** ..... **5**
- 1.1. Instructions and Symbols ..... 5
- 1.2. General ..... 5
- 1.3. Installation ..... 6
- 1.4. Operation ..... 6
- 1.5. Maintenance and Cleaning ..... 7
- 1.6. Disposing ..... 7
- 1.7. Warranty ..... 7
  
- 2. **Introduction** ..... **8**
  
- 3. **Technical Data** ..... **9**
  
- 4. **Connection to Digital Clock** ..... **10**
- 4.1. Connecting a Single Sensor ..... 10
- 4.2. Connecting Two Sensors ..... 11
  
- 5. **Digital Clock Settings** ..... **12**
- 5.1. Generation 4 Digital Clocks ..... 12
- 5.1.1. Temperature Correction ..... 12
- 5.2. Generation 3 Digital Clocks ..... 12
- 5.2.1. Temperature Correction ..... 12

# 1 Safety

---



Read the safety instructions carefully and follow all the instructions. This ensures safe and reliable operation of this device.

## 1.1. Instructions and Symbols

Symbols used throughout this document and their meaning are as follows:



A note or important information.



Answer to a possible question. Contact information.



Keep away from children and people with limited physical, sensory, or mental capacities.



Action needs to be taken.



Connect device to earth ground.



More information included in the manual.



Disconnect mains power before doing anything.



An example or a hint.



Additional references or information.



Attention of electrical shocks.



Surface may be hot.



Item is flammable.



A warning, be cautious.



Recyclable materials.



Do not put in trash.

## 1.2. General



For safety and licensing reasons, unauthorized modifications and/or changes to the product is prohibited. Maintenance, adjustments or repairs may only be carried out by the factory (copyright holder).



This product is not a toy; it does not belong in the hands of children. Mount or place the product so that it cannot be reached by children. Children may try to insert objects into the product. The product will not only be damaged, but there is also a risk of injury, as well as danger to life through electric shock.



Never open the housing of this product, for it poses mortal danger from electric shock or may even cause a fire.

Keep packaging such as plastic films away from children. There is the risk of suffocation of misused.



Use caution with the product, knocks, blows, or even falls from a low height can damage it.



In industrial facilities, the accident prevention regulations of the trade associations for electrical systems and equipment must be observed.

Do not use the product if it is damaged. It can be assumed that safe operation is no longer possible, if:

- The product has visible damage.
- The product is not working properly (thick smoke or a burning smell, audible crackling noise, discoloration of the product or surrounding areas).
- The product was stored under adverse conditions.
- Tough conditions during transport.



Improper handling of this product operated on the mains voltage can cause mortal danger from electric shock!



Interconnection or combining equipment bearing a CE label does not inevitably result in a system that conforms with the safety regulations. Integrators will have to reassess the new product's compliance according to the locally valid directives. See section Conformity for more information on certifications of this product.

## 1.3. Installation

This product must be connected and installed by a qualified electrician who is familiar with the relevant regulations (e.g. VDE).



Never plug the product into voltage / power supply immediately after it has been moved from cold into warm environment (e.g. during / after transport / unboxing). The resultant condensed water may damage the product or may cause electric shock.



Allow the product reach the ambient temperature. Wait until the condensation has evaporated, this can take a few hours. Only then can the product be connected to the voltage / current supply and put into operation.

## 1.4. Operation

Use the product in the specified environment. Use outside of the specifications can damage the product and/or stop any operation.

The product may not be exposed to extreme temperatures, direct sunlight or strong vibrations. Protect the product from moisture, dust and dirt.



Operation in environments with excessive dust, flammable gases, vapours or solvents is not permitted. It may cause explosion or fire.

- Do not overload the product. Note the input / output voltage and currents as well as output powers indicated on the product.
- Depending on the input currents and input voltages, suitable connecting cables with appropriate cable diameter must be used. Only use the plugs and connectors supplied in the original packaging with the product.

## 1.5. Maintenance and Cleaning

- If the product and/or the connecting cable is damaged, do not touch it: there is mortal danger from electric shock! First, turn off the power supply to all poles of the product. Verify the absence of voltage using an appropriate meter.
- For the end consumer, the product is maintenance-free. Leave any maintenance to an expert. Repairs may only be done by the factory itself (copyright holder).
- For external cleaning one can use a clean, soft, dry cloth. Dust can be easily removed with a clean, soft brush and a vacuum cleaner.

## 1.6. Disposing



At the end of its lifecycle, do not dispose of this device in the regular household rubbish. Return it to the supplier who will dispose of it correctly.



The user is lawfully obligated to return unusable batteries. **Disposal of used batteries through household waste is prohibited!** Batteries which contain dangerous substances are labelled with a picture of crossed out trash bin. The symbol means that this product may not be disposed through household waste.

Unusable batteries can be returned free of charge at appropriate collection points of your waste disposal company or at shops that sell batteries. By doing so, you fulfil your legal responsibilities and help protect the environment.



This product was packed and stuffed with proper materials to protect it during transportation. Packaging materials can be recycled and should be disposed environmentally friendly.

## 1.7. Warranty

The device is intended for a normal operational environment according to the corresponding norm.

The following circumstances are excluded from the warranty:

- Inappropriate handling or interventions.
- Chemical influences.
- Mechanical defects.
- External environmental influences (natural catastrophes, etc.)



Repairs during and after warranty period are assured by the manufacturer.

## 2 Introduction

---

Versatile temperature sensor designed for seamless integration with digital clocks. The TP 3m sensor is available in 3 m variant, offering a direct and hassle-free connection.

### Features

- Measurement of temperature within the range of -40 °C to +105 °C.
- Temperature sensor in a metal rod, within protection degree IP 66, with 3 m long cable connection.
- The sensors are designed to operate in non-aggressive environment.

## 3 Technical Data

---

Parameter	TP 3m
Scope of Measures Temperatures	-40 °C to +105 °C
Measuring Accuracy	±0.5 °C within the range of -10 °C to +85 °C; otherwise ±2 °C
Power Supply	3.3 VDC (supplied from the connected device)
Sensor Protection Degree	IP 66
Sensor Dimensions	ø5.7 x 60 mm
Sensor Connection Cable	3 m, PVC insulation



- For continuous temperature measurement in the liquid materials the sensor must be placed in thermowell (min. 80 mm).
- Minimum immersion sensor into the measured medium or thermowell is 80 mm.

# 4 Connection to Digital Clock

To the digital clock, one or two temperature sensors TP 3m (or combination of TP 3m + any other sensor) can be connected. In the case of two temperature sensors, they share a common power supply.

The sensor TP 3m is connected to the **TEMP** terminal block on digital clock PCB.

## 4.1. Connecting a Single Sensor

Wire Color	TEMP Terminal
Red	+
Blue	TEMP1
White	-

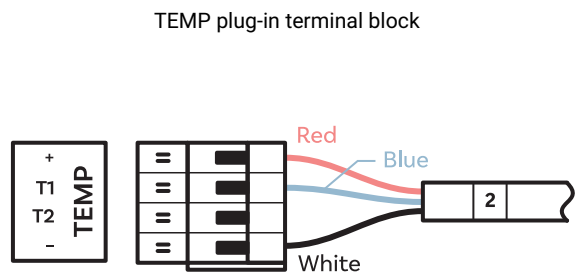
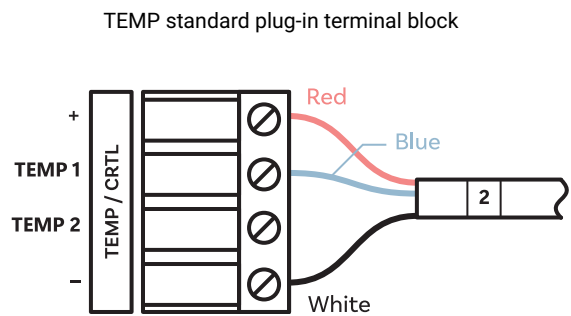

TEMP screw terminal block (directly on digital clock PCB)

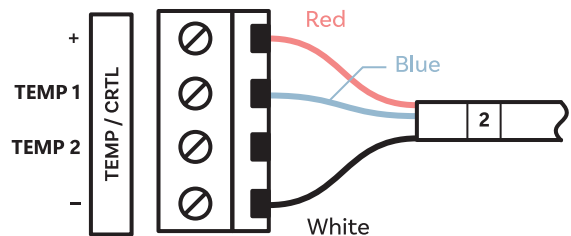

## 4.2. Connecting Two Sensors

Wire Color	TEMP Terminal
Red (both sensors)	+
Blue (sensor 1)	TEMP1
Blue (sensor 2)	TEMP2
White (both sensors)	-

TEMP standard plug-in terminal block

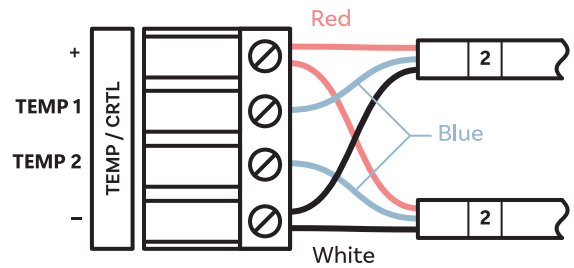

TEMP plug-in terminal block

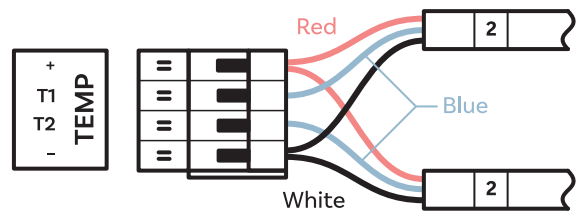

TEMP screw terminal block (directly on digital clock PCB)

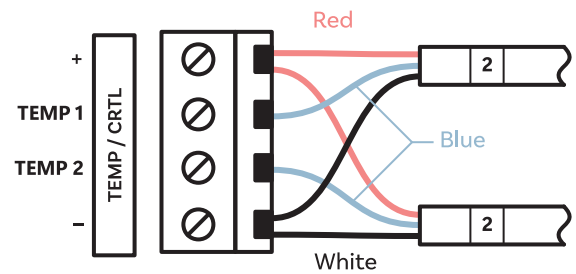

# 5 Digital Clock Settings

## 5.1. Generation 4 Digital Clocks

1. Enter the digital clock main menu, navigate to the **SE $\bar{N}$ 1** submenu and proceed to enter.
2. Navigate to item **E1** and check whether the value is set to **0**.
3. Navigate to item **I7** and set the value according to the input connector to which is the sensor connected.
4. The digital clock will display the measured temperature within about 20 seconds after connection.

### 5.1.1. Temperature Correction

Temperature sensors may have inherent inaccuracies or drift over time. If this is the case, you can set the temperature correction on display by following this procedure:

1. Enter the digital clock main menu, navigate to the **SE $\bar{N}$ 1** submenu and proceed to enter.
2. Navigate to item **E2** and proceed to enter the item which leads to submenu **CE** where the **-d.d** is displayed.

#### Submenu **CE**

Value	Range
<b>-d.d</b>	<p>- = negative value</p> <p><b>d.d</b> = value of correction set digit by digit, the range of each digit is 0–9</p> <p>Range: -9.9 to 9.9 °C</p>

3. Enter the edit mode of **-d.d** value:
  - a. First digit will flash. You can then set the negative ( **-** ) or positive value. Confirm your selection and move to next value **d**.
  - b. Second digit will flash. You can then set the numerical value in range 0–9. Confirm your selection and move to next value **.d**.
  - c. Third digit will flash. You can then set the decimal value in range 0–9. Confirm your selection to save end exit edit mode.



If you have more than 1 temperature sensor, repeat this procedure in **SE $\bar{N}$ 2** (respectively in **SE $\bar{N}$ 3** and **SE $\bar{N}$ 4**) menu.

## 5.2. Generation 3 Digital Clocks

1. Enter the digital clock main menu, navigate to **rB.\_.** (version) item.
2. Hold down the **PB1** and **PB2** buttons or the **DISP** button on the remote control and proceed to enter the service menu.
3. Navigate to item **C5**, proceed to enter and set the value to **1**.
4. The digital clock will display the measured temperature within about 20 seconds after connection.

### 5.2.1. Temperature Correction

Temperature sensors may have inherent inaccuracies or drift over time. If this is the case, you can set the temperature correction on display by following this procedure:

1. Enter the digital clock main menu, navigate to the **P12** submenu and proceed to enter.

2. The **c 1: 0** is displayed, the set correction is flashing. Change the flashing item to desired value in range -9 to +9 (°C or °F).
3. If you have second temperature sensor, navigate to item **c 2: 0** and repeat the previous step.
4. Save the values and return to main menu by pressing the **PB1L** or **OK** on the remote control.



*Headquarters/Production  
Sales Worldwide*

Tel. +41 34 432 46 46 | Fax +41 34 432 46 99  
moserbaer@mobatime.com | www.mobatime.com

*Sales Switzerland*

MOBATIME AG | Stettbachstrasse 5 | CH-8600 Dübendorf  
Tel. +41 44 802 75 75 | Fax +41 44 802 75 65  
info-d@mobatime.ch | www.mobatime.ch

MOBATIME SA | En Budron H 20 | CH-1052 Le Mont-sur-Lausanne  
Tél. +41 21 654 33 50 | Fax +41 21 654 33 69  
info-f@mobatime.ch | www.mobatime.ch

*Sales Germany/Austria*

BÜRK MOBATIME GmbH  
Postfach 3760 | D-78026 VS-Schwenningen  
Steinkirchring 46 | D-78056 VS-Schwenningen  
Tel. +49 7720 / 85 35 - 0 | Fax +49 7720 / 85 35 - 11  
buerk@buerk-mobatime.de | www.buerk-mobatime.de